



پورتال تخصصی
مواد مهندسی
و فرایندهای
ساخت و تولید

www.asremavad.com

<https://t.me/asremavad>

VISIT US ON:     



SCI PUBLICATION P291

Structural Design of Stainless Steel

N R BADDOO MA CEng MICE

B A BURGAN BSc MSc DIC PhD CEng MIStructE

Published by:
The Steel Construction Institute
Silwood Park
Ascot
Berkshire SL5 7QN
Tel: 01344 623345
Fax: 01344 622944

© 2001 The Steel Construction Institute

Apart from any fair dealing for the purposes of research or private study or criticism or review, as permitted under the Copyright Designs and Patents Act, 1988, this publication may not be reproduced, stored or transmitted, in any form or by any means, without the prior permission in writing of the publishers, or in the case of reprographic reproduction only in accordance with the terms of the licences issued by the UK Copyright Licensing Agency, or in accordance with the terms of licences issued by the appropriate Reproduction Rights Organisation outside the UK.

Enquiries concerning reproduction outside the terms stated here should be sent to the publishers, The Steel Construction Institute, at the address given on the title page.

Although care has been taken to ensure, to the best of our knowledge, that all data and information contained herein are accurate to the extent that they relate to either matters of fact or accepted practice or matters of opinion at the time of publication, The Steel Construction Institute, the authors and the reviewers assume no responsibility for any errors in or misinterpretations of such data and/or information or any loss or damage arising from or related to their use.

Publications supplied to the Members of the Institute at a discount are not for resale by them.

Publication Number: SCI P291

ISBN 1 85942 116 4

British Library Cataloguing-in-Publication Data.

A catalogue record for this book is available from the British Library.

FOREWORD

This document is a design guide for stainless steel written for engineers experienced in the design of carbon steel structural steelwork but not necessarily in the design of stainless steel structures. The purpose of this guide is to promote the safe and efficient use of stainless steel in structures.

Since there is no British Standard for designing structural stainless steel, this guide is based on the new version of BS 5950-1, *Code of Practice for design in simple and continuous construction*, published by BSI in 2000. The guidance provided is an extension of the code as appropriate to the design of stainless steel structures. Where the detailed code rules are unsuitable for the design of stainless steel elements, the guide draws on the recommendations given in the trial Eurocode for stainless steel, ENV 1993-1-4 and other sources, with suitable modification to bring the recommendations into the format of BS 5950-1:2000. Design examples are included to demonstrate the use of the recommendations.

This guide combines, updates and replaces three former SCI publications concerned with the structural design of stainless steel:

- Concise guide to the structural design of stainless steel (P123)
- Stainless steel fixings and ancillary components (P119)
- Section property and member capacity tables for cold formed stainless steel (P152)

The preparation of these earlier publications was sponsored by the following organisation:

Allott & Lomax (now, Babcie Group Allott & Lomax)	Fox Wire Limited
Ancon Stainless Steel Fixings Ltd. (now, Ancon Building Products)	Halfen Limited
Arup Research and Development	Health & Safety Executive
Avesta Sheffield Ltd. (now, AvestaPolarit Ltd.)	Hilti (Great Britain) Limited
Chevron (UK) Limited	International Chromium Development Association
Department of the Environment, Transport and the Regions (now, Department of Transport, Local Government and the Regions)	Nickel Development Institute
	Shell UK Exploration & Production.

The work leading up to this publication was sponsored by AvestaPolarit Ltd.

This publication was prepared by Nancy Baddoo and Dr Bassam Burgan, both of The Steel Construction Institute. Valuable comments were received from Dr Allan Mann (Babcie Group Allott & Lomax), Roger Crookes (BSSA - Stainless Steel Advisory Service) and Abdul Malik (SCI).

New design information on circular hollow sections and fire resistance has also been added, based on recommendations from a recently completed ECSC-funded project *Development of the use of stainless steel in construction*.

Further technical information on stainless steel is available online via the electronic advisory service on the British Stainless Steel Association web site www.bssa.org.uk. This web site also hosts a stainless steel products and services locator.

Contents

	Page No.
FOREWORD	iii
SUMMARY	vii
NOTATION	xi
1 INTRODUCTION	1
1.1 What is stainless steel?	1
1.2 Scope of this publication	3
1.3 General design principles	3
2 PROPERTIES AND SELECTION OF MATERIALS	6
2.1 Basic stress-strain behaviour	6
2.2 Properties	7
2.3 Selection of materials	19
3 DESIGN OF CROSS-SECTIONS	22
3.1 General	22
3.2 Gross cross-section	22
3.3 Net area	22
3.4 Effective net area	23
3.5 Influence of rounded corners	23
3.6 Shear lag	24
3.7 Flange curling	24
3.8 Classification of cross-sections	25
4 DESIGN OF MEMBERS	32
4.1 Introduction	32
4.2 Tension members	32
4.3 Compression members	33
4.4 Members in bending	37
4.5 Members subject to combined loading	49
5 DESIGN OF CONNECTIONS	52
5.1 Design considerations and assumptions	52
5.2 Bolted connections	52
5.3 Pin connections	57
5.4 Preloaded bolts	57
5.5 Securing nuts against vibration	57
5.6 Welded connections	57
6 FIRE RESISTANT DESIGN	59
6.1 General	59
6.2 Mechanical properties at elevated temperatures	60
6.3 Thermal properties at elevated temperatures	62
6.4 Determination of structural fire resistance	62
6.5 Calculation of temperature rise in stainless steel	69

7	FABRICATION ASPECTS	70
7.1	General	70
7.2	Storage and handling	70
7.3	Shaping operations	71
7.4	Welding	72
7.5	Finishing	74
7.6	Galling and seizure	74
8	INTRODUCTION TO DESIGN TABLES	76
8.1	General	76
8.2	Gross section properties	80
8.3	Effective section properties	83
8.4	Members in compression	85
8.5	Members in tension	88
8.6	Members in bending	89
9	REFERENCES	91
10	SOURCES OF FURTHER INFORMATION	94
10.1	Web sites	94
10.2	Advisory services	95
APPENDIX A	Specifications covering stainless steel fixings and ancillary components	96
APPENDIX B	Limits on cross-sections	97
APPENDIX C	Sections with large internal corner radii	98
DESIGN EXAMPLES		101
	Design example 1	102
	Design example 2	106
	Design example 3	110
	Design example 4	121
DESIGN TABLES		127
	Index to design tables	128

SUMMARY

This document is a guide to the design of stainless steel structures for engineers. The guide gives design recommendations, design examples, section properties and member capacities for commonly used stainless steel sections. This guide applies to the design of the grades of stainless steel that are widely used in structural applications, including the austenitic grades 1.4301 (304), 1.4401 (316) and their low carbon variants. Duplex grades 1.4362 (SAF 2304) and 1.4462 (2205) are also covered. The recommendations on structural design given in the guide have, as far as is practicable, been harmonized with BS 5950-1: 2000.

The guide gives recommendations on how to select the most appropriate grade of stainless steel for a given application. It provides information on the mechanical properties, physical properties and design strength of stainless steel. The guide covers aspects of material behaviour, cross-section design, member design, connections, fabrication and fire resistant design. Design examples are included to illustrate the use of the design recommendations.

Based on these design recommendations, a comprehensive set of design tables is presented, giving gross and effective section properties, section classification and member capacities for a wide range of cold formed stainless steel sections. The structural forms covered by the design tables are circular, rectangular and square hollow sections, channels, double channels back to back, equal angles and equal angles back to back. The grades of stainless steel covered in the tables are austenitic stainless steel grades 1.4301 (304), 1.4401 (316), 1.4404 (316L) and the duplex grades 1.4362 (SAF 2304) and 1.4462 (2205).

Dimensionnement structural de l'acier inoxydable

Résumé

Ce document constitue un guide de dimensionnement des structures réalisées en acier inoxydable et est destiné aux ingénieurs. Il s'applique aux types d'aciers inoxydables les plus utilisés dans les structures, y compris les aciers austénitiques 1.4301 (304), 1.4401 (316) et leurs variantes à bas taux de carbone. Les types Duplex 1.4362 (SAF 2304) et 1.4462 (2205) sont aussi pris en considération. Les recommandations données dans ce guide ont été, autant que possible, harmonisées avec celles de la BS 5950-1 : 2000.

Le guide montre comment choisir le type d'acier inoxydable le plus approprié pour une application donnée. Des informations concernant les propriétés mécaniques et physiques, ainsi que sur la résistance de dimensionnement des aciers inoxydables sont fournies dans le guide. Il couvre également les aspects relatifs au comportement du matériau et au dimensionnement des sections droites, des éléments de structures et des assemblages. La résistance à l'incendie est également prise en compte. Des exemples illustrent l'utilisation des recommandations.

Sur base des recommandations du guide, un ensemble de tables de dimensionnement donnent les propriétés des sections, les propriétés effectives des éléments à parois minces, la classification des sections et les capacités portantes. Ces tables sont établies pour une grande série de sections. Les tables couvrent les formes structurales suivantes : les profils creux circulaires, rectangulaires et carrés, les profils en U et C, les cornières ainsi que

les U, C et cornières accolées. Les types d'acier inoxydables repris dans les tables sont les aciers austénitiques de nuances 1.4301 (304), 1.4401 (316), 1.4404 (316 L) et les duplex de nuances 1.4362 (SAF 2304) et 1.4462 (2205).

Berechnung von Tragwerken aus Rostfreiem Stahl

Zusammenfassung

Dieses Dokument ist eine Anleitung für Ingenieure zur Berechnung von Tragwerken aus rostfreiem Stahl. Es gilt für die Berechnung von rostfreien Stahlgütern die häufig für Tragwerke eingesetzt werden, einschließlich der austenitischen Güten 1.4301 (304), 1.4401 (316) und deren Varianten mit niedrigem Kohlenstoffgehalt. Die Duplexgüten 1.4362 (SAF 2304) und 1.4462 (2205) werden auch erfaßt. Die Empfehlungen zur Berechnung sind, sofern praktikabel, abgestimmt mit BS 5950-1:2000.

Die Anleitung gibt Empfehlungen zur Auswahl der am besten passenden rostfreien Stahlgüten für eine gegebene Anwendung. Sie liefert Informationen über die mechanischen und physikalischen Eigenschaften sowie Festigkeiten des rostfreien Stahls. Die Anleitung behandelt Aspekte des Materialverhaltens, der Querschnitts- und Bauteilberechnung, der Verbindungen und Fertigung und der Brandsicherheit. Berechnungsbeispiele illustrieren den Gebrauch der Berechnungsempfehlungen.

Auf der Grundlage dieser Berechnungsempfehlungen wird ein umfassendes Tafelwerk vorgestellt, das für eine breite Palette von kaltgeformten Querschnitten aus rostfreiem Stahl, Querschnittsgrößen des Brutto- und des wirksamen Querschnitts, Querschnittsklasse und Tragfähigkeiten angibt. Folgende Querschnitte sind im Tafelwerk vorhanden: kreisförmige, rechteckige und quadratische Hohlquerschnitte, U- und Doppel-U-Querschnitte, gleichschenklige Winkel- und Doppelwinkel-Querschnitte. Die erfaßten rostfreien Stahlgüten sind die austenitischen Güten 1.4301 (304), 1.4401 (316), 1.4404 (316L) und die Duplexgüten 1.4362 (SAF 2304) und 1.4462 (2205).

Proyecto de estructuras en acero inoxidable

Resumen

Este documento es una guía para ingenieros que proyectan estructuras de acero inoxidable. Se aplica al proyecto de calidades de acero inoxidable ampliamente usados en la práctica incluyendo las calidades austeníticas 1.4301 (304), 1.4401 (316) y sus variantes de bajo contenido de carbono.

También se tratan las calidades dobles 1.4362 (SAF 2304) y 1.4462 (2205). Las recomendaciones dadas en la guía se han armonizado, según costumbre, con la BS 5950-1: 2000

La guía recomienda procedimientos de selección de la calidad de acero inoxidable más apropiada para cada aplicación y contiene información sobre las propiedades mecánicas, físicas y de resistencia de los aceros inoxidables. También abarca aspectos relacionados con el comportamiento del material, diseño de la sección transversal, diseño de barras, uniones, fabricación y proyecto de resistencia al fuego. Se incluyen ejemplos para ilustrar el uso de las recomendaciones.

Basados en ellas se presenta una colección de tablas muy completas que proporcionan las propiedades brutas y netas de las secciones conformadas en frío. La tipología estructural está formada por secciones circulares, rectangulares y cuadradas huecas, en forma de U, doble U, alma contra alma, angulares de lados iguales y angulares iguales opuestos. Las calidades de acero inoxidable tabuladas son auteríticas 1.4301 (304); 1.4401 (316); 1.4404 (316L) y las calidades dobles 1.4362 (SAF 2304) y 1.4462 (2205)

Progettazione strutturale di costruzioni in acciaio inossidabile

Sommario

Questa pubblicazione costituisce una guida per gli ingegneri alla progettazione di strutture in acciaio inossidabile e si applica a quei tipi di acciaio inossidabile comunemente utilizzati in applicazioni strutturali, includendo anche l'acciaio austenitico 1.4301 (304), 1.4401 (316) e le loro varianti a basso tenore di carbonio. Sono anche considerati i tipi duplex 1.4362 (SAF 2304) e 1.4462 (2205). Le raccomandazioni sulla progettazione strutturale riportate nella guida sono state armonizzate, nei limiti del possibile, con la norma BS 5950-1: 2000.

La guida fornisce raccomandazioni su come selezionare il tipo di acciaio inossidabile più appropriato per una determinata applicazione. Sono riportate informazioni sulle proprietà meccaniche e fisiche e sulla resistenza di progetto dell'acciaio inossidabile. La guida copre argomenti legati al comportamento dei materiali, alla progettazione della sezione trasversale e dell'elemento, ai collegamenti, alla fabbricazione e alla progettazione al fuoco. Sono proposti nella pubblicazione esempi di calcolo finalizzati ad illustrare le raccomandazioni di calcolo.

Sulla base delle regole di calcolo illustrate viene riportato un insieme esaustivo di tabelle progettuali in cui, per un numero sufficientemente ampio di elementi in acciaio inossidabile sagomati a freddo, sono trattate le proprietà nominali ed efficaci delle sezioni trasversali, la classificazione delle sezioni e la capacità portante degli elementi.

Le sezioni strutturali considerate in queste tabelle progettuali sono quelle tubolari circolari, tubolari rettangolari, tubolari quadrate, a C, composte a doppio C, con angolari uguali e composte con angolari uguali. I tipi di acciaio inossidabile considerati sono quelli austenitici 1.4301 (304), 1.4401 (316), 1.4404 (316L) e i tipi duplex 1.4362 (SAF 2304) e 1.4462 (2205).

Byggkonstruktion i rostfritt stål

Sammanfattning

Detta dokument är en guide för konstruktion i rostfritt stål avsedd för ingenjörer. Den behandlar konstruktion i de vanligaste förekommande rostfria stålen som används i byggsektorn, inklusive de austenitiska stålen 1.4301 (304), 1.4401 (316) och dess varianter med lågt kolinnehåll. Duplexstålen 1.4362 (SAF 2304) och 1.4462 (2205) behandlas också. Rekommendationerna har så långt som möjligt harmoniserats med den Brittiska standarden BS 5950-1: 2000.

Guiden innehåller rekommendationer för val av det bäst lämpade rostfria stålsorten för en given tillämpning. Den innehåller information om mekaniska och fysiska egenskaper, samt data om materialens hållfasthet. Guiden behandlar även hur materialet beter sig,

tvärsnittsdata, detaljutformning, sammanfogning, tillverkning och beaktande av brand. Olika exempel är också inkluderade för att illustrera användandet av denna guide.

Ett antal innehållsrika tabeller, baserade på dessa rekommendationer, är inkluderade. De innehåller bl.a. bruttotvärsnitt, effektiva tvärsnitt, klassificering av olika sektioner, och egenskaper för ett stort antal kallformade rostfria detaljer. De olika tvärsnittsformerna som behandlas är cirkulära, rektangulära och kvadratiska rör, C-profiler, dubbla C-profiler, L-profiler och dubbla L-profiler. De rostfria stål som behandlas är 1.4301 (304), 1.4401 (316), 1.4404 (316L) och de duplexa stålen 1.4362 (SAF 2304) och 1.4462 (2205).

NOTATION

A_e	effective cross-section area of a member at a connection with fastener holes
A_{eff}	effective area of slender cross-section under compression loading
A_g	gross cross-section area
A_t	tensile stress area of a bolt
A_v	shear area of a cross-section
A_s	shear area of a bolt
a	web panel length between transverse stiffeners
b	outstand length or flat width of internal flange of rectangular hollow section or width of panel between webs
B	external width of section
b_{eff}	effective width of a slender compression element
c	depth of an edge stiffener, or distance from neutral axis to back of section
d	external depth of equal angle, flat depth of web of rectangular or square hollow section, or nominal bolt diameter
D	external section depth of channel, or rectangular or square hollow section, or diameter of hole
E	Young's Modulus
E_s	secant modulus
e	shift of neutral axis of a class 4 slender cross-section under compression
e_1	end distance
e_2	edge distance
F	axial force in member
F_q	compression force in a transverse web stiffener
F_s	shear force in a bolt
F_x	local compressive force applied through a flange by a load or reaction
F_t	tension force
F_v	shear force in a member
G	shear modulus
H	warping constant
J	torsion constant
K_1, K_2	correction factor for sections with large internal corner radii
L	length of member measured between supports
L_E	effective length of member relevant to the axis of buckling
L_{Ez}	effective length of member unsupported against twisting
M	bending moment

M_b	moment resistance to lateral torsional buckling
M_c	moment capacity of section in the absence of axial load
P_{bb}	bearing capacity of a bolt
P_{bs}	bearing capacity of a connected ply
P_c	buckling resistance of a compression member
P_E	critical elastic flexural buckling load of a member in compression
P_{nom}	nominal tension capacity of a bolt
P_{sb}	shear capacity of a bolt
P_{sq}	local capacity of cross-section under uniform compressive stress
P_t	local capacity of cross-section under uniform tensile stress
P_v	shear capacity of a cross-section
p_{bb}	bearing strength of a bolt
p_{bs}	bearing strength of a connected ply
p_{sb}	shear strength of a bolt
p_t	tension strength of a bolt
p_y	design strength
p_w	design strength of a fillet weld
r	radius of gyration of the gross cross-section
r_e	external corner radius
r_i	internal corner radius
r_m	average corner radius (mid-line dimension)
r_o	polar radius of gyration of cross-section about shear centre $= \sqrt{r_x^2 + r_y^2 + x_0^2 + y_0^2}$
S	plastic section modulus of gross cross-section
t or T	thickness or thickness of a connected ply at a bolted connection
u	buckling parameter
u_o	distance from shear centre to centroid of gross cross-section along u -axis
U_s	specified minimum ultimate tensile strength
U_{sb}	specified minimum ultimate tensile strength of bolt material
x	torsional index
x_o	distance from shear centre to centroid of gross cross-section along x -axis
y_o	distance from shear centre to centroid of gross cross-section along y -axis
$Y_{0.2}$	specified minimum 0.2% proof stress
$Y_{0.2b}$	specified minimum stress in a bolt material at 0.2% permanent strain
Z	elastic section modulus of gross cross-section
Z_{eff}	elastic section modulus of effective section

<i>a</i>	imperfection factor
<i>b_c</i>	resistance factor under compression
<i>β_w</i>	resistance factor under bending
<i>c</i>	reduction factor to account for buckling in compression members
<i>c_{LT}</i>	reduction factor to account for lateral torsional buckling in bending members
<i>e</i>	constant = $\sqrt{\frac{275}{p_y} \frac{E}{205000}}$
<i>d</i>	correction factor due to rounded corners
<i>g_f</i>	load factor
<i>l</i>	slenderness under flexural buckling (= L_E/r)
<i>l_{LT}</i>	slenderness under lateral torsional buckling
\bar{l}_0	limiting slenderness
<i>s_{0.2}</i>	average value of the actual 0.2% proof stress of the material measured in tests
<i>s_{m0.2}</i>	average value of the 0.2% proof stress of the material given on the mill certificate or release certificate
<i>s_{max}</i>	maximum stress in section based on design (factored) loads
<i>n</i>	Poisson's ratio (= 0.3)

The following convention has been adopted in this publication:

<i>x-x</i> axis	major principal axis for single and double channels, rectangular and square hollow sections, rectangular axis for single angles but axis of symmetry for double angles
<i>y-y</i> axis	minor principal axis for single and double channels, rectangular and square hollow sections, rectangular axis for single angles axis normal to the axis of symmetry for double angles
<i>u-u</i> axis	major principal axis for single angles
<i>v-v</i> axis	minor principal axis for single angles
<i>z-z</i> axis	longitudinal axis along member length.

[Discuss me ...](#)

1 INTRODUCTION

1.1 What is stainless steel?

Stainless steel is the name given to a family of corrosion and heat resistant steels containing a minimum of 10.5% chromium. Just as there is a range of structural and engineering carbon steels meeting different requirements of strength, weldability and toughness, so there is a wide range of stainless steels with progressively higher levels of corrosion resistance and strength. This variety of grades results from the controlled addition of alloying elements, each offering specific attributes in respect of strength and ability to resist different environments. To achieve the optimum economic benefit from using stainless steel, it is important to select a grade of steel which is adequate for the application without being unnecessarily highly alloyed and costly.

With chromium content above 10.5% and in the presence of air or any other oxidising environment, a transparent and tightly adherent layer of chromium-rich oxide forms spontaneously on the surface of the steel. If the film is damaged by scratching or cutting, it will reform immediately in the presence of oxygen. Although the film is very thin (about 5×10^{-6} mm), it is both stable and non porous, thus preventing the steel from reacting further with the atmosphere. For this reason, it is called a passive layer. The stability of this passive layer depends on the composition of the steel, its surface treatment and the corrosive nature of its environment. Its stability increases as the chromium content increases and is further enhanced by alloy additions of nickel and molybdenum.

The grades of stainless steel can be classified into the following five basic groups (further information on the various groups and types of stainless steels may be found in standard texts^[1,2,3]).

Austenitic stainless steels

The most widely used types of stainless steel are based on 17-18% chromium and 8-11% nickel additions. In comparison to standard structural carbon steels, these steels have a modified atomic (crystal) structure. As a result, austenitic stainless steels, in addition to their corrosion resistance, have high ductility, are amenable to cold forming and are readily weldable. They also have significantly better toughness over a wide range of temperatures, compared with standard structural grades. They can usually be strengthened by cold working, but cannot be strengthened by heat treatment. The corrosion performance can be further enhanced by additions of molybdenum.

Ferritic stainless steels

The chromium content of the most popular ferritic stainless steels is between 10.5 and 18%. Ferritic stainless steels contain less nickel than austenitic grades and the atomic structure is the same as structural carbon steels. As a result, they are generally less ductile, less formable, less weldable and less corrosion resistant than austenitic stainless steels. They can be strengthened by cold working, but to a more limited degree than the austenitic grades. Like the austenitic grades, they cannot be strengthened by heat treatment. They are not as corrosion resistant as austenitic stainless steels and so applications are normally limited to indoor components such as handrails and shop-fittings.

Duplex stainless steels

Duplex stainless steels have a mixed microstructure of austenite and ferrite, and so are sometimes called austenitic-ferritic steels. They typically contain 21 - 26% chromium, 4 - 8% nickel and 0.1 - 4.5% molybdenum additions. Compared to the austenitic and ferritic steels, they offer the combination of relatively high strength and good corrosion performance. These grades have very good resistance to the form of corrosion known as stress corrosion cracking (see Section 2.2.5), compared with the austenitic grades typically used in construction. Although duplex stainless steels have good ductility, their higher strength results in more restricted formability, compared to the austenitic grades. They can also be strengthened by cold working, but, like the austenitic and ferritics on which they are based, they cannot be strengthened by heat treatment. The modern compositions of duplex stainless steels have good weldability and, provided that welding speed and heat input are controlled, maintain their excellent corrosion resistance after welding. Welding distortion should be lower in duplex stainless steels than in the austenitic grades, due to the lower thermal expansion rate of the duplex grades.

Duplex steels should generally be used when a material has to withstand high mechanical stresses under severe corrosion conditions. They have good resistance to stress corrosion cracking and high fatigue strength. They are currently used in the chemical and offshore industries for tubing, shafts and valves as well as for components in desalination plants. Duplex steels have been used for tension bars and pins in the construction industry.

Martensitic stainless steels

Martensitic stainless steels have a similar microstructure to ferritic and structural carbon steels but, due to their higher carbon content, can be strengthened by heat treatment. The corrosion resistance of martensitic stainless steels is similar to that of ferritic grades. Their ductility is more limited than the ferritic, austenitic and duplex grades. Although most martensitic stainless steels can be welded, this may require pre-heat and post weld heat treatments, which can limit their use in welded components. Although they are cheaper than austenitic steels, their low corrosion resistance limits the range of suitable applications to components such as valves, dies and knife blades.

Precipitation hardened steels

Precipitation hardened steels can be strengthened by heat treatment to very high strengths. The strengthening mechanism is different from that in the martensitic grades; due to the lower carbon levels, the strength after heat treatment of precipitation hardened steels is generally not as high as in the martensitic grades, but the tensile strength and toughness can be expected to be better. These steels are not normally used in welded fabrication. The corrosion resistance of these steels is generally better than the martensitic or ferritic grades and is similar to the 18% chromium, 8% nickel austenitic grades. Although they are mostly used in the aerospace industry, proprietary grades such as FV.520B have been used for certain heavy duty connections in buildings as well as for tie-bolts and reinforcing bars.

1.2 Scope of this publication

The recommendations given in this guide apply to the grades of stainless steel that are typically used in structural applications. The most widely used grades¹, commonly referred to as the standard austenitic grades, are 1.4301 (304) and 1.4401 (316). Grades 1.4307 (304L) and 1.4404 (316L) are lower carbon versions of the near-identical standard specifications and are also commonly used. The recommendations in this publication also apply to duplex grades such as 1.4462 (2205). Section 2.2 gives further information on material grades.

The guide is intended for the design of primary and secondary structural components. It covers aspects of material behaviour and selection, cross-section design, member design, connections, fire resistant design and fabrication. The guide is also not applicable to special structures such as those in nuclear installations or pressure vessels for which specific standards for stainless steel application already exist.

Specific guidance on the use of stainless steel in the water industry is available^[4]. Production, fabrication and surface finishes are covered in more detail in the *Architects' guide to stainless steel*^[5] (also available online at <http://www.steel-stainless.org/architects>). Design guidance concerning stainless steel handrails and balustrades has also been published^[6].

Design guidance and recommendations concerning good practice on the installation of stainless steel masonry support angles are given by a series of information sheets produced by the Masonry Support Information Group^[7,8,9]. The information is also published on the Group's web site (<http://www.masonrysupport.org>).

The recommendations in this publication should be used in conjunction with BS 5950-1:2000^[10]. These are concerned with the design of elements and members and not the behaviour and design of frameworks, for which the carbon steel rules are applicable. Plastic analysis is not yet appropriate to stainless steel. However, cross-sections that satisfy the requirements for class 2 can be designed to their full plastic moment capacity, $p_y S$ (Section 3.8.2).

No limitations on thickness are given in relation to brittle fracture; the limitations for carbon steel do not apply due to the superior toughness of stainless steel and the insensitivity of austenitic versions (see Section 2) to a temperature-controlled ductile-brittle transition. However, there will be practical limits on thickness for cold forming of members (approximately 20 mm for the austenitic grades and 15 mm for the duplex grades).

1.3 General design principles

The aims in designing a stainless steel structure are no different from those in carbon steel structures; a structure should be designed and fabricated so that:

- it remains fit for use during its intended life
- it can sustain the loads which may occur during construction, installation and usage

¹ In this publication, reference is made to both the European grade designation (e.g. 1.4301) and to the more familiar American (AISI) grade designation systems (e.g. 304).

- damage due to accidental loads will be localised
- it has adequate durability in relation to maintenance costs
- it retains its original appearance.

In addition to these considerations the design of a structure should take account of the following:

- safe transport and handling
- safe means of interconnection
- stability during erection.

The above requirements can be satisfied by using suitable materials, appropriate design and detailing and by specifying quality control procedures for construction. If necessary, a maintenance programme may also be specified. The engineer responsible for the overall stability of the structure should have an overview of stainless steel design considerations.

Structures should be designed by considering all relevant limit states. Four classes of limit states are recognised: ultimate limit states, serviceability limit states, accidental limit states and durability limit states. Ultimate limit states are those that, if exceeded, can lead to collapse of part or the whole of the structure, endangering the safety of people. Serviceability limit states correspond to states beyond which specified service criteria are no longer met. Accidental limit states relate to extreme events that the structure is required to survive but without the need for further reserve of strength. Durability limit states can be regarded as subsets of the ultimate and serviceability limit states, depending on whether the corrosion affects the strength of the structure or its aesthetic appearance. Examples of the key factors for these limit states are given below:

Ultimate Limit State

- Strength (including general yielding, rupture, buckling and transformation into a mechanism).
- Stability against over-turning and sway.
- Fracture due to fatigue.

Serviceability Limit State

- Deflection.
- Vibration (e.g. wind induced oscillation).
- Repairable damage due to fatigue.
- Creep.

Accidental Limit State

- Fire.
- Explosion.
- Seismic loading.

Durability Limit State

- Corrosion.
- Metallurgical stability.

Load factors in accordance with BS 5950-1 may be used for the serviceability and ultimate limit state design of stainless steel. In this guide, member forces arising from factored loads are referred to as design forces (e.g. design shear force). Load factors in accordance with BS 5950-8^[11] may be used for fire loading (see Section 6.1).

For stainless steel, durability limit states are as important as the ultimate and serviceability limit states. Durability can be considered by appropriate material selection and detailing of members and joints. It is not only an important consideration throughout the design phase but also during fabrication and erection.

2 PROPERTIES AND SELECTION OF MATERIALS

2.1 Basic stress-strain behaviour

The stress-strain behaviour of stainless steel differs from that of carbon steels in a number of respects. The most important difference is in the shape of the stress-strain curve. Whereas carbon steel typically exhibits linear elastic behaviour up to the yield stress and a plateau before strain hardening, stainless steel has a more rounded response with no well-defined yield stress (see Figure 2.1). Stainless steel 'yield' strengths are generally quoted in terms of a proof strength defined for a particular offset permanent strain (conventionally the 0.2% strain), as indicated in Figure 2.1, which shows typical experimental stress-strain curves. The curves shown are representative of the range of material likely to be supplied and should not be used for design. For 1.4301 (304) and 1.4401 (316) steels, the two curves shown indicate the extreme values from a series of tests and thus they represent a scatter band.

Stainless steels can absorb considerable impact without fracturing due to their excellent ductility (especially the austenitic grades) and their strain hardening characteristics. The work required to fracture the material is proportional to the area under the stress-strain curve.

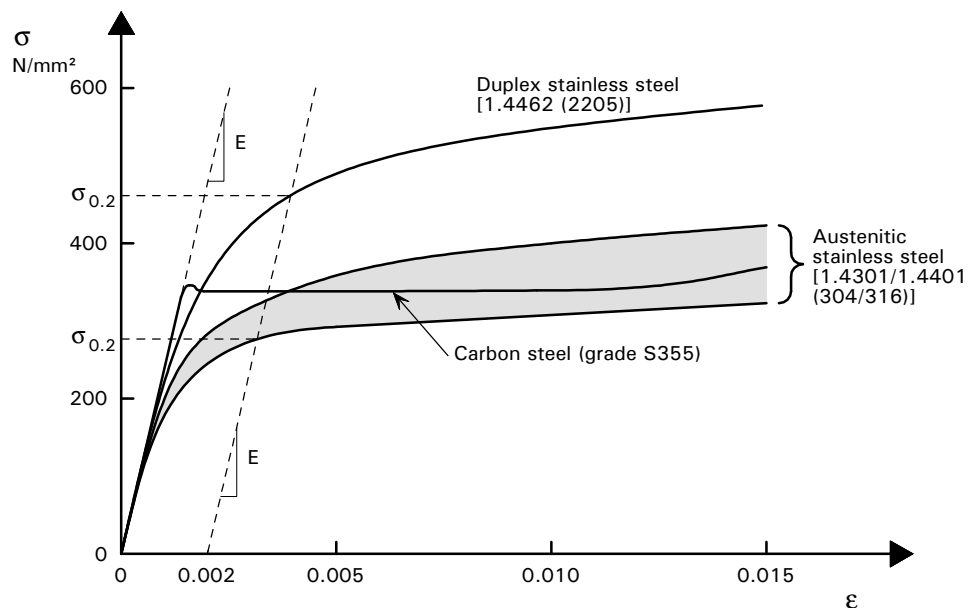

Figure 2.1 Typical stress-strain curves for stainless steel and carbon steel

($\sigma_{0.2}$ is the 0.2% proof strength, E is Young's modulus)

Note: These values should not be used in design

2.2 Properties

2.2.1 Relevant standards and grades

Design values of the mechanical properties are discussed in Section 2.2.2.

Flat products

The European material standard for stainless steel is BS EN 10088, *Stainless Steels*^[12]. The Parts are:

- Part 1, *List of stainless steels*, gives the chemical compositions and reference data on some physical properties such as modulus of elasticity, E .
- Part 2, *Technical delivery conditions for sheet, plate and strip for general purposes*, gives the technical properties and chemical compositions for the materials used either as flat products or for the cold forming of structural sections.
- Part 3, *Technical delivery conditions for semi-finished products, bars, rods and sections for general purposes*, gives the technical properties and chemical compositions for the materials used in long products.

BS EN 10088-2 covers the grades used in most construction applications. (It partly replaces BS 1449-2^[13], which also covered heat-resisting steels.) The applicable standards for dimensional tolerances are specified in BS EN 10088-2. Different minimum mechanical properties are given for cold rolled strip (up to 6 mm thick), hot rolled strip (up to 12 mm thick) and hot rolled plate (up to 75 mm thick).

The designation systems adopted in BS EN 10088 are the European steel number and a steel name.

For example, grade 304L has a steel number 1.4307, where:

1.	43	07
Denotes steel	Denotes one group of stainless steels	Individual grade identification

The steel name system provides some understanding of the steel composition. The name of the steel number 1.4307 is X2CrNi18-9, where:

X	2	CrNi	18-9
Denotes high alloy steel	100 x % of carbon	Chemical symbols of main alloying elements	% of main alloying elements

Each stainless steel name has a unique corresponding steel number. Note that whilst the German DIN *Werkstoff* numbers are similar, not all are identical to those in BS EN 10088.

Table 2.1 gives European designations for the grades covered in this publication, along with the more familiar corresponding British and American designations. Note that there are several grades in BS EN 10088 that have approximately equivalent compositions to the AISI grades 304, 304L, 316 and 316L.

Table 2.1 *European, British and American designations for corresponding stainless steel grades*

	European (BS EN 10088)		British	American (AISI)
	Number	Name		
Basic chromium-nickel austenitic steels	1.4301	X5CrNi18-10	304S15 304S16 304S31	304
	1.4307	X2CrNi18-9	304S11	304L
Molybdenum-chromium-nickel austenitic steels	1.4401	X5CrNiMo 17-12-2	316S31	316
	1.4404	X2CrNiMo17-12-2	316S11	316L
Stabilised austenitic steels	1.4541	X6CrNiTi18-10	321S31	321
	1.4571	X6CrNiMoTi17-12-2	320S31	316 Ti
Duplex steels	1.4362	X2CrNiN23-4	SAF 2304	-
	1.4462	X2CrNiMoN22-5-3	2205	-

The most commonly used grade in structural applications is 1.4301 (304), which is a basic chromium-nickel austenitic grade. Grade 1.4401 (316) is also widely used; it contains molybdenum in addition to chromium and nickel, which enhances its resistance to pitting and crevice corrosion. The low carbon versions of these grades are 1.4307 (304L) and 1.4404 (316L).

In the past, grades 1.4301 and 1.4401 had significantly higher carbon levels, with implications for corrosion behaviour². Either the 'L' grade, or a stabilised steel such as 1.4541 (321) had to be used where there was concern about corrosion performance in the as-welded condition.

However, using modern steelmaking methods, the standard carbon austenitic grades now have carbon contents of 0.05% or below, so the grade distinction is less important. The presence of weld heat tint is more likely to be a cause of corrosion attack in the welded condition than any effect of the carbon content slightly exceeding that of the 'L' grades. However, the 'L' grades remain the preferred choice for optimum corrosion performance after welding. Stabilised grades can be considered as alternatives to the 'L' grades and can be useful where elevated temperature strength is of concern. Where necessary, guidance

² Carbon present in the steel reacts with chromium and precipitates chromium carbides on grain boundaries under certain thermal cycles, e.g. in the weld heat affected zones (HAZ). The local loss of chromium from the boundary region into the carbide particles allows preferential intercrystalline corrosion attack and the steel is said to be *sensitized*, or suffer from *weld decay* (see Section 2.2.5).

on the need for a stabilised or 'L' grade steel for a particular fabrication should be sought from the steel supplier or fabricator.

Table 2.2 presents the values of the mechanical properties of the stainless steel grades covered in this publication. The values of the 0.2% proof stress specified in BS EN 10088 are generally about 15 N/mm² higher than those for the corresponding grades in the superseded standard BS 1449-2^[13]. Due to their higher carbon content, the standard carbon grades 1.4301 (304) and 1.4401 (316) tend to have slightly higher proof strength values than the corresponding low carbon grades.

Table 2.2 Specified properties to BS EN 10088-2

	Grade	Minimum 0.2% proof strength ⁽¹⁾ (N/mm ²) $Y_{0.2}$	Ultimate tensile strength (N/mm ²) U_s	Minimum elongation after fracture %
Basic chromium- nickel austenitic steels	1.4301 (304)	210	520 – 720	45 ⁽²⁾
	1.4307 (304L)	200	500 – 650	45
Molybdenum- chromium- nickel austenitic steels	1.4401 (316)	220	520 – 670	40
	1.4404 (316L)	220	520 – 670	40
Stabilised austenitic steels	1.4541 (321)	200	500 – 700	40
	1.4571 (320)	220	520 – 670	40
Duplex steels	1.4362 (SAF 2304)	400	600 – 850	20
	1.4462 (2205)	460	640 – 840	20

Notes:

The properties apply to material up to 75 mm thick.

(1) Transverse properties

(2) For stretcher levelled material, the minimum values is 5% lower

Fasteners

These are addressed in BS EN ISO 3506, *Corrosion-resistant stainless steel fasteners*^[14]. The specification gives chemical compositions and mechanical properties for fasteners in the austenitic, martensitic and ferritic groups. Alternative materials not specifically covered in the specification are permitted if they meet the physical and mechanical property requirements and have equivalent corrosion resistance.

In BS EN ISO 3506, bolt and nut materials are classified by a letter: 'A' for austenitic, 'F' for ferritic and 'C' for martensitic. To obtain the best corrosion resistance, it is recommended that austenitic fasteners are used. The letter is

followed by a number (1, 2, 3, 4 or 5) that reflects the corrosion resistance, '1' representing the least durable and '4' and '5' the most durable.

Steel grade A1 is specially designed for machining. Due to high sulphur content, the steels within this grade have lower resistance to corrosion than corresponding steels with normal sulphur content. Care should be exercised if Grade A1 fasteners are being considered, see Section 2.3.1.

Steels of grade A2 have equivalent corrosion resistance to grade 1.4301 (304).

Steels of grade A3 are stabilised stainless steels with equivalent corrosion resistance to grade 1.4541 (321). (A stabilised steel is one that contains an addition of a strong carbide-forming agent such as titanium, which reacts preferentially with carbon and prevents formation of chromium carbides – see Section 2.2.1.)

Steels of grade A4 contain molybdenum and have equivalent corrosion resistance to grade 1.4401 (316).

Steels of grade A5 are stabilised molybdenum-bearing stainless steels with properties of grade 1.4571 (320) steel.

Austenitic fasteners can be obtained in three ultimate strength levels (known as property classes), see Table 2.3. Note that the mechanical properties must be agreed between the user and manufacturer for fasteners larger than M24 for property classes 70 and 80 as the values depend on the alloy and manufacturing method.

The condition of the alloy in property class 50 fasteners is soft, resulting in the highest corrosion resistance. Fasteners in this property class are likely to be non-magnetic. Property classes 70 and 80 are formed by cold working (drawing). In this condition, the steel is likely to be magnetic and the corrosion resistance may be slightly lower than class 50. Property class 50 fasteners having machined threads may be more prone to thread galling, see Section 7.6.

Appendix A lists some British specifications covering stainless steel fixings and ancillary components.

Table 2.3 *Minimum specified mechanical properties of austenitic grade fasteners to BS EN ISO 3506*

Grade ⁽¹⁾	Property class	Thread diameter range	Bolts		Nuts
			Ultimate tensile strength ⁽²⁾ (N/mm ²) U_{sb}	Stress at 0.2% permanent strain (N/mm ²) $Y_{0.2b}$	Proof load stress (N/mm ²)
A1, A2,	50	≤ M39	500	210	500
A3, A4	70	≤ M24 ⁽³⁾	700	450	700
and A5	80	≤ M24 ⁽³⁾	800	600	800

Notes:

- (1) In addition to the various steel grades covered in BS EN ISO 3506 under property class 50, 70 and 80, other steel types to BS EN 10088-3 may also be used.
- (2) The tensile stress is calculated on the stress area.
- (3) For fasteners with nominal diameters $d > 24$ mm, the mechanical properties are to be agreed between user and manufacturer and marked with grade and property class according to this table.

Castings

Cast stainless steels generally have a different chemical composition and structure; this results in more varied mechanical properties than their wrought counterparts. Cast forms usually have similar corrosion resistance to the wrought forms. BS 3100^[15] and BS EN 10283^[16] give specifications for stainless steel castings for general engineering purposes.

Cast stainless steels have been used for a variety of fixings such as pin connections, hinges for dock gates and specific architectural features in exposed structures such as atrium roofs. They may also be used for load-bearing components where tight tolerances are required and when welding distortion would be too great. For large numbers of small and intricate fixings, castings are likely to be an attractive alternative to wrought fixings.

The guidance in this publication is confined to wrought stainless steels. For castings, it is usually necessary to carry out tests to verify the strength and durability characteristics. Guidance on the use of castings in construction is available^[17].

2.2.2 Design values of properties

Flat Products

The value of the modulus of elasticity, E is given by BS EN 10088-1 as 200,000 N/mm² for all the grades of stainless steel commonly used in construction. This value may be used in any buckling analysis. For estimating deflections, the secant modulus, E_s is more appropriate; see Section 4.4.8.

The value of Poisson's ratio, ν can be taken as 0.3. The value of the shear modulus, G for these grades can be taken as 76,900 N/mm².

For design strength, three options may be considered: minimum specified values, verified material test data and mill certificate data.

(i) Design using minimum specified values

Take the design strength, p_y , as the minimum specified 0.2% proof strength in BS EN 10088-2 and take the ultimate strength as the minimum specified ultimate tensile strength in BS EN 10088-2.

(ii) Design using test data

This should only be considered as an option where tensile testing has been carried out on coupons cut from the plate or sheet from which the members are to be formed or fabricated. It is recommended that the average result of at least three test coupons, orientated in the direction of the member axis, should be used. The designer should also be satisfied that the tests have been carried out to a recognised standard, e.g. BS EN 10002-1^[18], and that the procedures adopted by the fabricator are such that the member will be actually made from the tested material and positioned correctly within the structure.

Given appropriate QA procedures to satisfy the above requirements, it should then be permissible to take the design value of the 0.2% proof stress as:

$$p_y = s_{0.2} / 1.1$$

where $s_{0.2}$ is the average test value of the 0.2% proof stress.

It is suggested that the ultimate tensile strength should still be based on the minimum specified ultimate tensile strength given in BS EN 10088-2.

(iii) Design using mill certificate data

Measured values of the 0.2% proof stress are given on the mill (or release) certificate. The design value of the 0.2% proof stress can be taken as:

$$p_y = s_{m0.2} / 1.2$$

where $s_{m0.2}$ is the average value of the 0.2% proof stress as given on the mill certificate.

It is suggested that the ultimate tensile strength should still be based on the minimum specified ultimate tensile strength given in BS EN 10088-2.

Fasteners

For calculating the capacity of fasteners under tension, shear or their combination, the design strength should be based on the minimum specified stress at 0.2% permanent strain or on the ultimate tensile strength, as explained in Section 5.2.2.

2.2.3 Fatigue

Carbon steel rules for determining fatigue behaviour can safely be applied to stainless steel.

2.2.4 Physical properties

Physical properties at room temperature of the selected grades in the annealed condition (i.e. fully softened by a controlled heating and cooling cycle) are shown in Table 2.4. Physical properties may vary slightly with product form and size but such variations are usually not of critical importance to the application.

From a structural point of view, the most important physical property is the coefficient of thermal expansion; for the austenitic grades, it differs considerably from that for carbon steel (which is approximately $12 \times 10^{-6}/^{\circ}\text{C}$). The effects of differential thermal expansion should be considered in design.

Annealed austenitic stainless steels which have not been cold worked are not magnetic whilst duplex grades are magnetic. Where the non-magnetic properties of the austenitic grades are important to the application, care must be exercised in selecting appropriate welding consumables to minimise the ferrite content in the weldment. Heavy cold working, particularly of the lean alloyed austenitic steel, can also increase magnetic permeability. Subsequent annealing will restore the low magnetic permeability properties. It is recommended that further advice be sought for non-magnetic applications from the stainless steel producer.

Table 2.4 *Physical properties at room temperature to BS EN 10088-1 (annealed condition)*

Grade	Density (kg/m ³)	Thermal expansion 20 – 100°C (10 ⁻⁶ /°C)
1.4301 (304)	7900	16
1.4307 (304L)	7900	16
1.4401 (316)	8000	16
1.4404 (316L)	8000	16
1.4541 (321)	7900	15
1.4571 (320)	8000	16.5
1.4362 (SAF 2304)	7800	13
1.4462 (2205)	7800	13
For these grades:	thermal conductivity	= 15 W/m°C
	heat capacity	= 500 J/kg°C
	Young's modulus	= 200 000 N/mm ²

2.2.5 Durability

Stainless steels are generally very corrosion resistant and will perform satisfactorily in most environments. The limit of corrosion resistance of a given stainless steel depends on its constituent elements, which means that each grade has a slightly different response when exposed to a corrosive environment. Care is therefore needed to select the most appropriate grade of stainless steel for a given application. Generally, the higher the level of corrosion resistance required, the greater the cost of the material. For example, grade 1.4401 (316) steel costs more than grade 1.4301 (304) because this grade contains molybdenum and more nickel.

The most common reasons for a metal to fail to live up to expectations regarding corrosion resistance are:

- (a) incorrect assessment of the environment or exposure to unexpected conditions, e.g. unsuspected contamination by chloride ions
- (b) the way in which the stainless steel has been worked or treated may introduce a state not envisaged in the initial assessment.

Although stainless steel may be subject to discolouration and staining (often due to carbon steel contamination), it is extremely durable in buildings. In aggressive industrial and marine environments, tests have shown no indication of reduction in component capacity, even where a small amount of weight loss occurred. However, unsightly rust staining on external surfaces may still be regarded as a failure by the user. As well as careful material grade selection, good detailing and workmanship can significantly reduce the likelihood of staining and corrosion; practical guidance is given in Section 7. Experience indicates that any serious corrosion problem is most likely to show up in the first two or three years of service.

In certain aggressive environments, some grades of stainless steel will be susceptible to localised attack. Six mechanisms are described below, although the last three are very rarely encountered in building structures.

Pitting

Pitting is a localised form of corrosion which can occur as a result of exposure to specific environments, most notably those containing chlorides. In most structural applications, the extent of pitting is likely to be superficial and the reduction in section of a component is negligible. However, corrosion products can stain architectural features. A less tolerant view of pitting should be adopted for services such as ducts, piping and containment structures. If there is a known pitting hazard, then molybdenum-bearing stainless steels, e.g. 1.4401 (316), should be selected.

Crevice corrosion

Crevice corrosion is a localised form of attack which is initiated by the extremely low availability of oxygen in a crevice. It is only likely to be a problem in stagnant solutions where a build-up of chlorides can occur. The severity of crevice corrosion is very dependent on the geometry of the crevice; the narrower (< 25 μm) and deeper the crevice, the easier is crevice attack initiated. Crevices typically occur between nuts and washers or around the thread of a screw or the shank of a bolt. Crevices can also occur in welds which fail to penetrate and under deposits on the steel surface.

Bimetallic corrosion

Bimetallic (galvanic) corrosion may occur when dissimilar metals are in contact in a common electrolyte (e.g. rain, condensation etc.), forming a galvanic corrosion cell. If current flows between the two, the less noble metal (the anode) corrodes at a faster rate than would have occurred if the metals were not in contact.

The rate of corrosion also depends on the relative areas of the metals in contact, the temperature and the composition of the electrolyte. In particular, the larger the area of the 'noble' cathode in relation to that of the anode, the greater the rate of attack. Adverse area ratios are likely to occur with fasteners and at

joints. Bolts made from carbon steel (which is less noble than stainless steel) in stainless steel members should be avoided because the ratio of the area of the stainless steel to the carbon steel is large and the bolts will be subject to aggressive attack. Conversely, the rate of attack of a carbon steel member by a stainless steel bolt is much slower. It is usually helpful to draw on previous experience in similar sites, because dissimilar metals can often be safely coupled with no adverse effects under conditions of occasional condensation or dampness, as the conductivity of the electrolyte is usually low.

The prediction of bimetallic corrosion is difficult because the corrosion rate is determined by a number of interrelated issues. The use of corrosion potential tables ignores the presence of surface oxide films and the effects of area ratios and different solution (electrolyte) chemistry. Therefore, uninformed use of these tables may produce erroneous results. They should be used with care and only for initial assessment.

Austenitic stainless steels usually form the cathode in a bimetallic couple and therefore do not suffer corrosion. An exception is the couple with copper, which should generally be avoided except under benign conditions. Contact between austenitic stainless steels and zinc or aluminium may result in some additional corrosion of the latter two metals. This is unlikely to be significant structurally, but the resulting white/grey powder may be deemed unsightly.

Bimetallic corrosion may be prevented by excluding water from the detail (e.g. by painting or taping over the assembled joint) or isolating the metals from each other (e.g. by painting the contact surfaces of the dissimilar metals). Isolation around bolted connections can be achieved by non-conductive plastic or rubber gaskets and nylon or teflon washers and bushes. These systems may be time consuming to install in large structures and may necessitate expensive post-installation QA checks.

The general behaviour of metals in bimetallic contact in rural, urban, industrial and coastal environments is documented in PD 6484 *Commentary on corrosion at bimetallic contacts and its alleviation*^[19].

Stress corrosion cracking

The development of stress corrosion cracking (SCC) requires the simultaneous presence of tensile stresses and specific environmental factors unlikely to be encountered in normal building atmospheres. The stresses do not need to be very high in relation to the proof stress of the material and may be due to loading or residual effects from manufacturing processes such as welding or bending. Caution should be exercised when stainless steel members containing high residual stresses (e.g. due to cold working) are used in chloride rich environments (e.g. swimming pools, marine, offshore). Guidance on the selection of the most appropriate grade of stainless steel in swimming pool environments is available^[20].

Duplex stainless steels have greater resistance to stress corrosion cracking than the austenitic stainless steels covered in this guide. Higher alloy austenitic stainless steels (not covered in this guide) have been developed for applications where SCC is a corrosion hazard.

General (uniform) corrosion

General corrosion is much less severe in stainless steel than in other steels. It only occurs when the stainless steel is at a pH value of less than or equal to 1.0.

This form of corrosion is not a problem for the grades selected in this guide when used in structural applications. Reference should be made to tables in manufacturers' literature, or the advice of a corrosion engineer should be sought, if the stainless steel is to come into contact with chemicals.

Intergranular attack and weld decay

When austenitic stainless steels are subject to prolonged heating in the range 450°C to 850°C, the carbon in the steel diffuses to the grain boundaries and precipitates chromium carbide. This removes chromium from the solid solution and leaves a lower chromium content adjacent to the grain boundaries. Steel in this condition is termed *sensitized*. The grain boundaries become prone to preferential attack on subsequent exposure to a corrosive environment. This phenomenon is known as *weld decay* when it occurs in the heat affected zone of a weldment.

There are three ways to avoid intergranular corrosion:

- using steel having a low carbon content (i.e. 0.03% maximum),
- using steel stabilised with titanium or niobium (these elements combine preferentially to chromium with carbon to form stable particles, thereby reducing the risk of forming chromium carbide),
- heat treating (solution annealing) the steel. (This method is rarely used in practice.)

Grades of stainless steel with a low carbon content (0.03% maximum) up to about 20 mm thick should not suffer from intergranular corrosion after arc welding.

2.2.6 Detailing to improve durability

The most important step in preventing corrosion problems is selecting an appropriate grade of stainless steel with suitable fabrication procedures for the given environment. However, after specifying a particular steel, much can be achieved in realising the full potential of the steel's resistance by careful attention to detailing. Anti-corrosion actions should ideally be considered at the planning stage and at the latest on the drawing board.

Table 2.5 gives a check list for consideration. Not all points would give the best detail from a structural strength point of view and neither are the points intended to be applicable to all environments. In particular, in environments of low corrosivity or where regular maintenance is carried out, many would not be required. Figure 2.2 illustrates poor and good design features for durability.

Table 2.5 *Design for corrosion control*

Avoid dirt entrapment

- orientate angle and channel profiles to minimise the likelihood of dirt retention
- provide drainage holes, ensuring they are of sufficient size to prevent blockage
- avoid horizontal surfaces
- specify a small slope on gusset stiffeners which nominally lie in a horizontal plane
- use tubular and bar sections (sealing tubes with dry gas or air where there is a risk of harmful condensates forming)
- specify smooth finishes.

Avoid crevices

- use welded rather than bolted connections
- use closing welds or mastic fillers
- preferably dress/profile welds
- prevent biofouling.

Reduce the likelihood of stress corrosion cracking in those specific environments where it may occur (see Section 2.2.5):

- minimise fabrication stresses by careful choice of welding sequence
- shot peen (but avoid the use of iron/steel shot).

Reduce likelihood of pitting (see Section 7)

- remove weld splatter
- pickle stainless steel to remove unwanted welding products. Strongly oxidising chloride-containing reagents such as ferric chloride should be avoided; rather a pickling bath or a pickling paste, both containing a mixture of nitric acid and hydrofluoric acid, should be used. Welds should always be cleaned up to restore corrosion resistance.
- avoid pick-up of carbon steel particles (e.g. use a workshop area and tools that are dedicated to stainless steel)
- follow a suitable maintenance programme.

Reduce likelihood of bimetallic corrosion (see Section 2.2.5)

- electrical insulation
 - use paints appropriately
 - minimise periods of wetness
 - use metals that are close to each other in electrical potential.
-

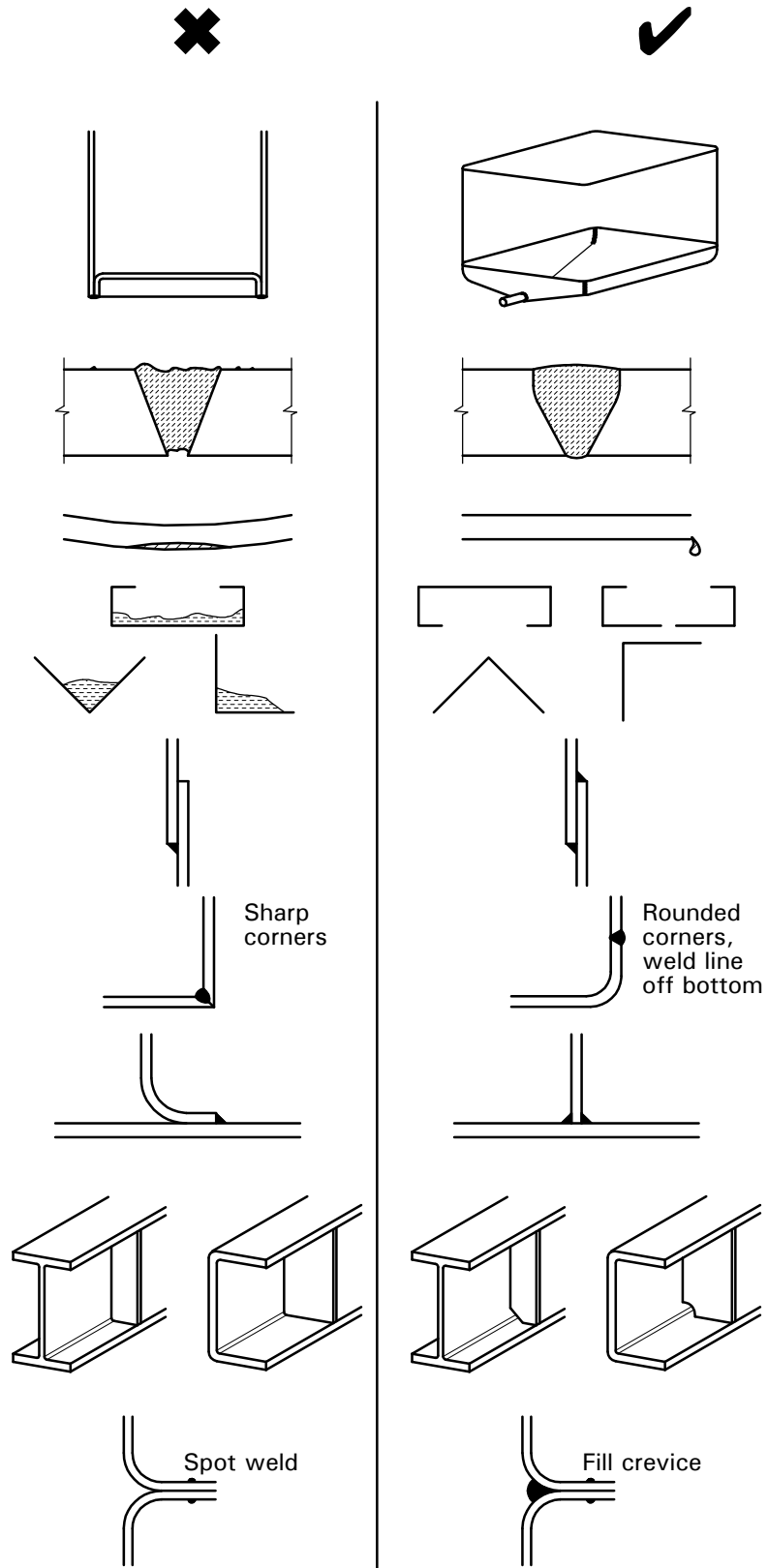

Figure 2.2 *Poor and good design features for durability*

2.3 Selection of materials

2.3.1 Grades

The selection of the correct grade of stainless steel must take into account the environment of the application, the fabrication route, surface finish and the maintenance of the structure. Although the material has low maintenance requirements, where it is selected for use in a corrosive environment, corrosion engineering needs to be appropriately considered.

The first step is to characterise the service environment. The corrosiveness of an environment is governed by a number of variables such as humidity, air temperature, presence of chemicals and their concentration, oxygen content, etc. Moisture must be present for corrosion to occur. For example, heated and ventilated buildings can be classified as dry and corrosion is unlikely to occur in such environments. The risk of condensation is higher in areas such as kitchens and laundries. Coastal areas can be very corrosive, due to the presence of high concentrations of chloride ions in the air, and structures exposed to sea spray are particularly at risk to corrosive attack.

Having characterised the general environment, it is then necessary to consider the effect of the direct surroundings on the stainless steel (e.g. elements and substances which the material is likely to come into contact with). The surface condition, the temperature of the steel and the anticipated stress could also be important parameters.

Consideration should then be given to mechanical properties. The different types of loading should be defined (e.g. service loads, cyclic loads, vibrations, seismic loads). The effect of heating/cooling cycles may also need to be quantified. Ease of fabrication, availability of product forms, surface finish and cost also need to be considered.

Assessing the suitability of grades is best approached by referring to experience of stainless steels in similar applications and environments. Table 2.6, which is based on Figure 1 from *Advantages for Architects*^[21], gives guidance for selecting suitable grades for atmospheric environments. It is based on long term exposure of stainless steel sheet samples at a variety of locations. Expert advice should always be sought for more specialist applications (e.g. stainless steel immersed or in contact with chemicals).

Caution should be exercised when considering the use of 'free-machining' stainless steels for fasteners. The addition of sulphur in the composition of these steels (commonly designated 1.4305 (303) in the austenitic class) renders them more liable to corrosion than their non-treated counterparts (1.4301 (304) in this case), especially in industrial and marine environments. This applies to fasteners in BS EN ISO 3506 grade A1 materials.

If there is any doubt as to which grade should be used for a particular application, advice should be sought. Further technical information on stainless steel can be obtained from the electronic advisory service on the British Stainless Steel Association web site (<http://www.bssa.org.uk>) Topics covered include corrosion resistance, material selection, mechanical and physical properties, welding and specifications.

Table 2.6 *Suggested grades for atmospheric applications*

Steel grade	Location											
	Rural			Urban			Industrial			Marine		
	L	M	H	L	M	H	L	M	H	L	M	H
Basic chromium-nickel austenitic steels (e.g. 1.4301)	✓	✓	✓	✓	✓	(✓)	(✓)	(✓)	X	✓	(✓)	X
Molybdenum-chromium-nickel austenitic steels (e.g. 1.4401)	0	0	0	0	✓	✓	✓	✓	(✓)	✓	✓	(✓)
Duplex grade 1.4462	0	0	0	0	0	0	0	0	✓	0	0	✓

L Least corrosive conditions within that category, e.g. tempered by low humidity, low temperatures.
M Fairly typical of that category.
H Corrosion likely to be higher than typical for that category, e.g. increased by persistent high humidity, high ambient temperatures, and particularly aggressive air pollutants.
O Potentially over-specified from a corrosion point of view.
✓ Probably the best choice for corrosion resistance and cost.
X Likely to suffer excessive corrosion.
(✓) Worthy of consideration if precautions are taken (i.e. specifying a relatively smooth surface and if regular washing is carried out).

2.3.2 Availability of product forms

General types of product form

Sheet, plate and bar products are all widely available in the grades of stainless steel considered in this guide. Tubular products are available in austenitic grades and also the duplex grade 1.4462 (2205). Tubular products in the duplex grade 1.4362 (SAF 2304) are not widely available as this is a relatively new grade to the construction industry, although it has been used for some years for offshore blast walls.

There is a limited range and availability of rolled sections (angles, channels, tees, rectangular hollow sections and I-sections) in standard austenitic grades such as 1.4301 (304) and 1.4401 (316) but none for duplex grades. (Note that a wider range of rolled sections is available for the normal carbon content grades 1.4301 and 1.4401 than for the low carbon content grades, 1.4307 (304L) and 1.4404 (316L).) Sections may also be produced by cold forming (rolling or bending), or fabricated by welding.

Cold forming

It is important that early discussion with potential fabricators takes place to ascertain cold forming limits, as stainless steels require higher forming loads than carbon steels. The length of brake-pressed cold formed sections is necessarily limited by the size of machine, or by power capability in the case of thicker or stronger materials. Duplex grades require approximately twice the forming loads used for the austenitic materials and consequently the possible range of duplex sections is more limited. Furthermore, because of the lower ductility in the duplex material, more generous bending radii may need to be used. Further information may be found in Section 7.3.2.

Surface finish

Surface finish can have an important effect on the corrosion resistance and aesthetic appeal of a structure. There is a wide variety of finishes available that are suitable for structural and architectural applications. These range from standard ex-steel mill finishes to special polished (mechanically or electropolished), textured and coloured finishes. It should be noted that although the various finishes are standardised, variability in processing introduces differences in appearance between manufacturers and even from a single producer. Bright finishes are frequently used in architectural applications, however, they can exaggerate any out-of-flatness of the material, particularly on panel surfaces. Rigidised, embossed, textured, patterned or profiled sheets with a rigid supporting frame will alleviate this tendency. Surface finishes are specified in BS EN 10088-2. Further information on surface finishes is given in the *Architects' guide to stainless steel*^[5].

Fasteners

Fasteners to BS EN ISO 3506 property class 70 are the most widely available. Certain size restrictions apply to fasteners in property classes 70 and 80, see Table 2.3. It is possible to have 'specials' made to order and indeed, this sometimes produces an economical solution.

Fasteners can be produced by a number of techniques, e.g. machining, cold forming and forging. Machined threads should be used with caution in very aggressive environments (e.g. marine), due to potential problems with crevice corrosion. Rolled threads are to be preferred because they are also generally stronger than machined threads and provide greater resistance to thread galling.

Stainless steel washers, nuts, studs, rivets and self-tapping screws are widely available. Austenitic grade 1.4567 (394) stainless steel contains copper, which reduces the level of work hardening and permits easier cold heading; it is used for rivets, bolts, screws and nuts. Ferritic grade 1.4016 (430) steel is also used for rivets.

Stainless steel self-tapping screws are mostly used in aluminium, plastic or wood, although they may be used in any material in which a hole is drilled first. Stainless steel screws with carbon steel drill heads have been developed for roofing and cladding applications. Care is required when stainless steel self-tapping screws are used in a stainless steel base material, in order to avoid seizure of the screw or stripping its thread due to the strain-hardening properties of the stainless steel base material. It is recommended that procedure trials are carried out to determine pull-out strengths of such connections.

Stainless steel is particularly useful for fine threads, e.g. fasteners less than 5 mm in diameter, because it is difficult to apply protective coating on such small scale components. Stainless steel HSTFG (high strength friction grip) bolts are not generally available (see Section 5.4).

3 DESIGN OF CROSS-SECTIONS

3.1 General

This Section is concerned with the local behaviour of members. The local capacity of a member is dependent on the capacity of the constituent elements of the cross-section. Elements, and hence the cross-section, may be affected by local buckling, which reduces their effectiveness to carry load. The width-to-thickness ratio of elements that are partly or wholly in compression determine whether they are subject to local buckling, with a consequential reduction in the capacity of the cross-section. Elements and cross-sections are classified as class 1, 2, 3 or 4, depending on their susceptibility to local buckling (see Section 3.8).

As in the case of carbon steel rules, a reduced capacity of 'class 4 slender' cross-sections may be allowed for in design by applying the effective width/effective section concept. The effective section should be used throughout the design of the member except where specifically noted otherwise. This reduction need not be made in the design of connections to that element.

It is important to note that flat outstand elements without an edge lip or stiffener (see Appendix B) with b/t ratios greater than approximately 30 and flat elements supported otherwise with b/t ratios greater than approximately 75 are likely to develop visual distortion at the serviceability limit state. Therefore, care should be taken not to exceed these limits where the exposed surfaces of stainless steel are important for architectural purposes.

The recommendations in Section 3 and 4 apply to cross-sections with elements complying with the dimensional limits given in Appendix B.

3.2 Gross cross-section

When calculating gross geometrical section properties, the specified size and profile of the member or elements should be used. Holes for fasteners need not be deducted but allowance should be made for larger openings.

3.3 Net area

The net area of a section or element of a section should be taken as its gross area less appropriate deductions for all openings, including holes for fasteners. In the deductions for fasteners, the sectional area of the hole in the plane of its own axis should be deducted, not that of the fastener. Whether holes are staggered or not, the area to be deducted may be calculated in accordance with BS 5950-1, clause 3.4.4^[10].

3.4 Effective net area

The effective net area, a_e , of each element of a cross-section at a connection with fastener holes may be taken as K_e times its net area but not more than its gross area, a_g where:

$$K_e = 1.2 \text{ for austenitic grades, including 1.4301 (304), 1.4401 (316), 1.4307 (304L) and 1.4404 (316L)}$$

$$K_e = 1.0 \text{ for duplex grades 1.4362 (SAF 2304), 1.4462 (2205)}$$

3.5 Influence of rounded corners

In cross-sections with rounded corners, the influence of rounded corners on section properties should be allowed for. This may be done with sufficient accuracy by reducing the properties calculated for an otherwise similar cross-section with sharp corners using the following approximations:

$$A_g = A_{g,sh} (1 - d) \quad (3.1)$$

$$I = I_{sh} (1 - 2d) \quad (3.2)$$

$$H = H_{sh} (1 - 4d) \quad (3.3)$$

with

$$d = 0.43 \frac{\sum_{j=1}^n r_{m,j}}{\sum_{i=1}^q b_i} \quad (3.4)$$

where:

A_g is the area of the gross cross-section

$A_{g,sh}$ is the value of A_g for a cross-section with sharp corners

I is the second moment of area of the gross cross-section

I_{sh} is the value of I for a cross-section with sharp corners

H is the warping constant of the gross cross-section

H_{sh} is the value of H for a cross-section with sharp corners

q is the number of plane elements

n is the number of curved elements

b_i is the width of plane element i for a cross-section with sharp corners (mid-line dimension), see Figure 3.1

$r_{m,j}$ is the average corner radius (mid-line dimension) of curved element j , see Figure 3.1.

The reductions given above may also be applied in calculating the effective section properties A_{eff} , $I_{x,eff}$, $I_{y,eff}$ and H_{eff} , provided that the widths of the plane elements are measured to the points of intersection of their midlines.

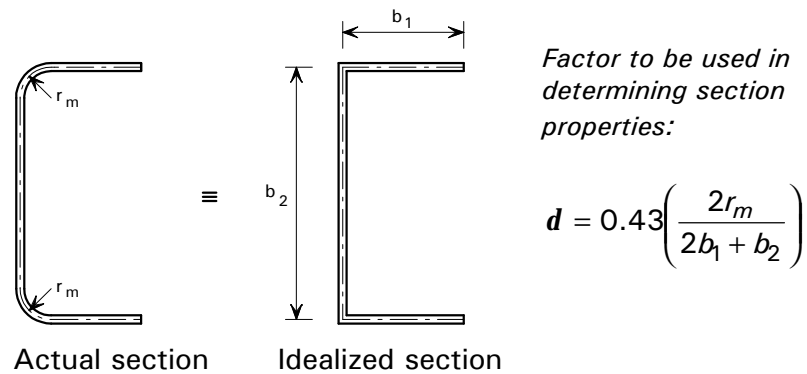

Figure 3.1 Influence of rounded corners on channel section properties

3.6 Shear lag

For all classes of cross-sections, the effect of shear lag on flange behaviour (whether the flange is in tension or compression) may be neglected, provided that:

- for internal elements $b \leq L/10$
- for outstand elements $b \leq L/20$

where:

L is the length between points of zero moment

b is the breadth or outstand distance (see Figure 3.2).

For situations where these limits are exceeded, guidance on accounting for shear lag effects can be found in BS 5400-3^[22].

3.7 Flange curling

For unusually wide thin flanges in a profile subjected to flexure, flange curling (or movement of the flange towards the neutral axis) may occur. The magnitude of curling, u , for initially straight members, may be estimated from the following formula, which applies to both compression and tension flanges, with or without stiffeners.

$$u = 2.3 \frac{p_a^2}{E^2} \frac{b_s^4}{T^2 \bar{y}} \quad (3.5)$$

where:

b_s is $b/2$ for multiweb members (e.g. box and hat sections) or b for outstands

p_a is the average longitudinal stress in flange (= force in flange, determined for the effective section, divided by gross area of flange) at the ultimate limit state

\bar{y} is the distance from neutral axis to the middle of the flange under consideration.

The effect of flange curling on the capacity of the section should be considered where u exceeds 5% of the depth of the section. The visual and practical implications of any degree of flange curling must also be considered. The effect of flange curling is allowed for by calculating the design resistance with reference to the deformed cross-section (idealized, for instance, by assuming that part of the flange is situated nearer the centroid). Conservatively, the depth of the entire cross-section can be reduced by the amount of flange curling.

3.8 Classification of cross-sections

3.8.1 General

Cross-sections should be classified to determine whether local buckling influences their capacity. It is necessary to classify each element in a cross-section that is subject to compression (due to a bending moment or an axial force). Classification thus depends on the proportion of moment or axial load present in an element and thus can vary along the length of a member and with the axis of bending under consideration. Classification of an element of a cross-section is based on its width-to-thickness ratio. The dimensions of these compression elements should be taken as shown in Figure 3.2.

A distinction should be made between the following types of element:

- **outstand elements** attached to an adjacent element at one edge only, the other edge being free.
- **internal elements** attached on both longitudinal edges to other elements or to longitudinal stiffeners which effectively support the element, including: **webs** (internal elements perpendicular to the axis of bending) and **flanges** (internal elements parallel to the axis of bending).

All compression elements should be classified in accordance with Section 3.8.2. The classification of a cross-section depends on the highest (least favourable) class of its constituent compression elements.

Circular hollow sections should be classified separately for axial compression and for bending.

3.8.2 Classification

In principle, stainless steel cross-sections may be classified in the same way as those of carbon steel. Classifications are defined as follows:

Class 1 plastic: cross-sections that can develop their plastic moment capacity (p_y times the plastic modulus) with the rotation capacity required for plastic analysis. (Note: only elastic analysis is recommended for stainless steel.) Elements subject to bending with or without axial compression that meet the limits for class 1 given in Table 3.1 should be classified as class 1 plastic.

Class 2 compact: cross-sections that can develop their plastic moment capacity but with limited rotation capacity. Elements subject to bending with or without axial compression that meet the limits for class 2 given in Table 3.1 should be classified as class 2 compact.

Class 3 semi-compact: cross-sections that can reach the yield moment (p_y times the elastic modulus) but local buckling prevents the development of the plastic moment capacity. Elements subject to compression that meet the limits for class 3 given in Table 3.1 should be classified as class 3 semi-compact.

Class 4 slender: cross-sections are those in which local buckling is liable to prevent the development of the yield moment. Elements subject to compression that do not meet the limits for class 3 given in Table 3.1 should be classified as class 4 slender (see Section 3.8.4).

As the yield point on the stress-strain curve of non-linear materials is an arbitrary choice, so are the yield and plastic moments. The obvious definitions to apply are the elastic and plastic section moduli times a proof stress, conventionally the 0.2% proof stress (see Section 2.2.2). This proof strength is designated the design strength, p_y .

Table 3.1 replaces Tables 11 and 12 in BS 5950-1, which apply only to carbon steel.

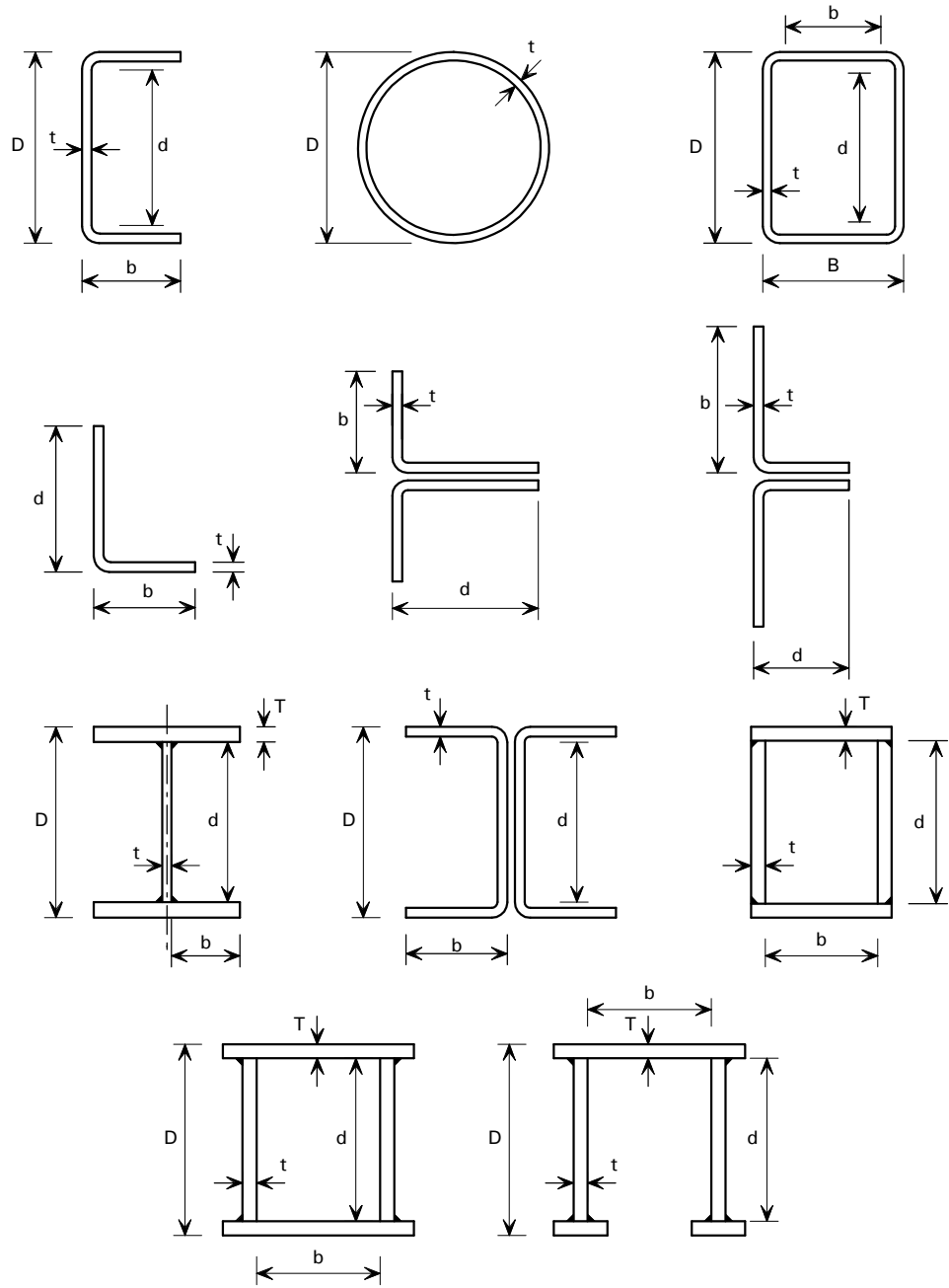

Figure 3.2 *Dimensions of compression elements*

Note that for rectangular hollow sections, d and b are the flat widths, whereas for channels, d is the flat width but b is the total outstand width. For angles, d and b are the leg lengths.

Where d and b relate to the flat width:

$$d = D - 2(r_i + t) \quad \text{and} \quad b = B - 2(r_i + t) \quad \text{where } r_i \text{ is the internal radius}$$

$$\text{A typical value of } r_i \text{ is } 2t \text{ which gives } d = D - 6t \quad \text{and} \quad b = B - 6t$$

Table 3.1 Limiting width-to-thickness ratios for section classification

(Elements which exceed these limits are to be taken as class 4 (slender) cross-sections)

Compression element		Ratio ⁽¹⁾	Limiting value ⁽²⁾⁽³⁾			
			Class 1 plastic	Class 2 compact	Class 3 Semi-compact	
Outstand element of compression flange	Cold formed	b/t	8.5ϵ	9.5ϵ	11ϵ	
	Welded	b/t	7.5ϵ	8.5ϵ	10.2ϵ	
Internal element of compression flange	Compression due to bending	b/t	23ϵ	25ϵ	28ϵ	
	Axial compression	b/t	Not applicable			
Web	Neutral axis at mid-depth	d/t	52ϵ	54ϵ	69ϵ	
	Generally ⁽⁴⁾⁽⁵⁾	If r_1 is negative	d/t	$\frac{572e}{13r_1 + 11}$ but $\geq 28 \epsilon$	$\frac{594e}{13r_1 + 11}$ but $\geq 28 \epsilon$	$14.1e\sqrt{k_s}$ but $\geq 28 \epsilon$
		If r_1 is positive	d/t	$\frac{52e}{r_1 + 1}$ but $\geq 28 \epsilon$	$\frac{54e}{r_1 + 1}$ but $\geq 28 \epsilon$	
	Axial compression ⁽⁴⁾	d/t	Not applicable			
Angle, compression due to bending (both criteria should be satisfied)		b/t	8.5ϵ	9.5ϵ	11ϵ	
		d/t	8.5ϵ	9.5ϵ	11ϵ	
Single angle, or double angles with the components separated, axial compression (all three criteria should be satisfied)		b/t	Not applicable		11ϵ	
		d/t			11ϵ	
		$\frac{b+d}{t}$			16.8ϵ	
Outstand leg of an angle in contact back-to-back in a double angle member		b/t	8.5ϵ	9.5ϵ	11.0ϵ	
Outstand leg of an angle with its back in continuous contact with another component						
Circular hollow sections	Compression due to bending	D/t	$41 \epsilon^2$	$58 \epsilon^2$	$234 \epsilon^2$	
	Axial compression	D/t	Not applicable		$74 \epsilon^2$	
Grade	1.4307 (304L)	1.4301 (304)	1.4401/1.4404 (316/316L)	1.4362 (SAF 2304)	1.4462 (2205)	
ϵ	1.16	1.13	1.10	0.819	0.764	
Notes						
(1) Dimensions b , d , D and t are as defined in Figure 3.2. For a rectangular hollow section b is the flange dimension and d the web depth, where the distinction between webs and flanges depends upon whether the section is bent about its major axis or its minor axis, see Section 3.8.2.						
(2) Check webs for shear buckling when $d/t \geq 39.5e$ (Section 4.4.5)						
(3) $e = \left[\frac{275}{p_y} \frac{E}{205000} \right]^{0.5}$ where p_y is the design strength and E is 200,000 N/mm ² (see Section 2.2.2)						
(4) $k_\sigma = \frac{16}{\left[(1+y)^2 + 0.112(1-y)^2 \right]^{0.5} + (1+y)}$ for $-1 \leq \psi \leq 1$						
$k_s = 5.98(1-\psi)^2$ for $-2 \leq \psi \leq -1$ and ψ is defined in Figure 3.3						
(5) The stress ratio r_1 is defined in Section 3.8.3.						

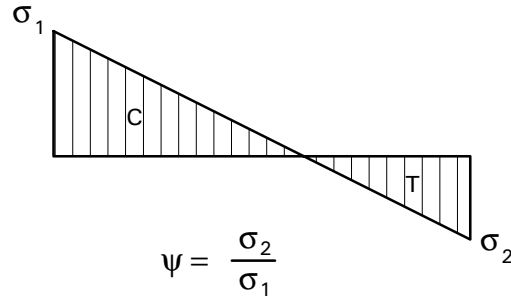

Figure 3.3 Definition of ratio ψ

Note: In this figure σ_2 is negative, hence ψ is negative. When σ_1 and σ_2 are compressive, ψ will be positive.

3.8.3 Stress ratio for classification

The stress ratio r_1 used in Table 3.1 should be determined from the following:

- (a) for I or H-sections with equal flanges:

$$r_1 = \frac{F_c}{dtp_{yw}} \quad \text{but} \quad -1 < r_1 \leq 1 \quad (3.6)$$

- (b) for I or H-sections with unequal flanges:

$$r_1 = \frac{F_c}{dtp_{yw}} + \frac{(B_t T_t - B_c T_c) p_{yf}}{dtp_{yw}} \quad \text{but} \quad -1 < r_1 \leq 1 \quad (3.7)$$

- (c) for RHS or welded box sections with equal flanges:

$$r_1 = \frac{F_c}{2dtp_{yw}} \quad \text{but} \quad -1 < r_1 \leq 1 \quad (3.8)$$

where:

- A_g is the gross cross-sectional area
- B_c is the width of the tension flange
- B_t is the width of the tension flange
- d is the web depth
- F_c is the axial compression (negative for tension)
- p_{yf} is the design strength of the flange, (p_y is as defined in Section 2.2.2)
- p_{yw} is the design strength of the web (but $p_{yw} \leq p_{yf}$) (p_y is as defined in Section 2.2.2)
- T_c is the thickness of the compression flange
- T_t is the thickness of tension flange
- t is the web thickness.

3.8.4 Slender cross-sections

The local buckling resistance of class 4 slender cross-sections may be allowed for in design by adopting effective section properties. The effective area of a slender cross-section in compression and/or bending, A_{eff} , is the gross area of the cross-section minus the sum of the ineffective areas of each slender element making up the cross-section. The effective area of each slender element is the effective breadth b_{eff} calculated from Table 3.2 multiplied by the element thickness. When the cross-section is subject to bending, an effective moment of inertia I_{eff} and effective section modulus Z_{eff} also need to be calculated.

For singly symmetric and unsymmetric cross-sections, due allowance should be made for the additional moments induced in the member due to the shift of the centroid of the effective cross-section compared to the gross cross-section (see also Section 8.3.3). These additional moments are obtained by assuming that the axial compressive force F_c acts at the centroid of the gross cross-section, but is resisted by an equal and opposite force acting at the centroid of the effective cross-section that corresponds to the case of a uniform stress equal to the design strength p_y acting throughout its effective cross-sectional area. The additional moments should be taken into account in the checks on cross-section capacity and member buckling resistance given in Section 4, except where a more onerous condition occurs if they are omitted.

Table 3.2 *Effective width of slender elements*

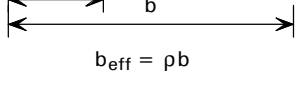
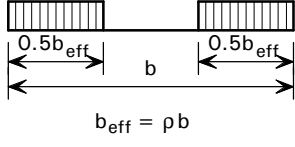
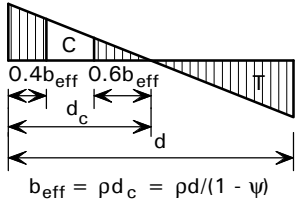
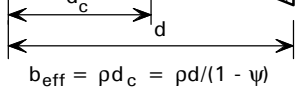
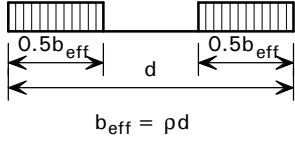
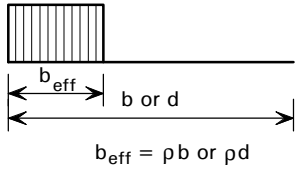
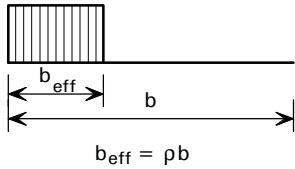
Type of element	Type of section	Effective width factor ⁽¹⁾	Effective width
Outstand element of compression flange	Welded	$r = \frac{19}{\frac{b}{te} + 8.8}$	
	Cold formed	$r = \frac{19}{\frac{b}{te} + 8}$	
Internal element of compression flange	All sections	$r = \frac{44}{\frac{b}{te} + 16}$	
Web with neutral axis at mid-depth ⁽²⁾⁽³⁾	All sections	$r = \frac{106}{\frac{d}{te} + 37}$	
Webs generally ⁽²⁾⁽³⁾	All sections	$r = \frac{21.8\sqrt{k_s}}{\frac{d}{te} + 7.7\sqrt{k_s}}$	
Web where whole section is subject to compression	All sections	$r = \frac{44}{\frac{d}{te} + 16}$	
Legs of single angles under uniform compression	All sections	$r = \text{the lesser of } \frac{19}{\frac{b}{te} + 8} \text{ or } \frac{28.8}{\frac{b+d}{te} + 12}$	
Outstand legs of double angles connected back-to-back	Cold formed	$r = \frac{19}{\frac{b}{te} + 8}$	

Notes

- 1) Dimensions b , d , t are as defined in Figure 3.2. ϵ is defined in Table 3.1.
- 2) k_s and ψ are as defined in Table 3.1 and Figure 3.3.
- 3) When calculating the effective width of flange elements, the value of y should be determined for the gross section. The effective width of a web element should be based on the stress ratio, y , determined for a cross-section comprising the effective area of the compression flange and the gross area of the web and tension flange.

4 DESIGN OF MEMBERS

4.1 Introduction

The design checks required for stainless steel members are similar to those carried out for carbon steel members. It is recommended that the forces and moments in the members are derived from an elastic global analysis. In verifying the adequacy of the structure to carry the forces, consideration should be given to overall buckling of members, in addition to the cross-sectional capacity.

A possible design approach for checking against buckling in stainless steel members is to use the tangent modulus (corresponding to the buckling stress) instead of the initial modulus (as used in carbon steel rules). Assuming similar levels of geometric and residual stress imperfections in carbon steel and stainless steel members, this generally leads to satisfactory results when it is based on validated carbon steel rules. This approach is therefore available to the designer but it requires iterative solution techniques and therefore has been avoided in this guide, for simplicity. In some cases it has been used to derive effective design curves for use with the initial modulus, thereby removing the need for the designer to perform the iterations. The design strength, p_y , should be obtained by one of the methods outlined in Section 2.2.2.

The Sections below which deal with buckling strength are intended for use with single, double or point-symmetric uniform sections. The buckling resistance of members not possessing any longitudinal plane or axis of symmetry should be verified by tests. Further information on testing stainless steel structural elements is given in the Euro Inox *Design Manual for Structural Stainless Steel*^[23].

4.2 Tension members

Members subject to tension only do not suffer any instability due to buckling. The design of such members needs therefore to be based only on the cross-section capacity, usually at the connections (see Section 5).

The capacity, P_t , of a cross-section subject to uniform tensile stresses is given by:

$$P_t = p_y A_e \quad (4.1)$$

where A_e is the sum of the effective net areas of all the elements of the cross-section, as determined from Section 3.4.

When members are connected eccentrically to the axis of the member, the resulting moment should be allowed for (see Section 4.5). However, angles, channels and T-sections with eccentric end connections may be treated simply as axially loaded by using a reduced tension capacity.

For a simple tie consisting of a single angle connected through one leg only, a single channel connected only through the web or a T-section connected only through the flange, the tension capacity is given by:

$$\text{For bolted connections: } P_t = p_y (A_e - 0.5a_2) \quad (4.2)$$

$$\text{For welded connections: } P_t = p_y (A_g - 0.3a_2) \quad (4.3)$$

where:

A_g is the gross cross-sectional area

$$a_2 = A_g - a_1$$

a_1 is the gross area of the connected element, taken as the product of its thickness and the overall leg width for an angle, the overall depth for a channel or the flange width for a T-section

p_y is as defined in Section 2.2.2.

For a simple tie consisting of two angles connected through one leg only, two channels connected only through the web, or two T-sections connected only through the flange, the tension capacity is given as follows:

- a) If the tie is connected to both sides of a gusset or section and the components are interconnected by bolts or welds and held apart and longitudinally parallel by battens or sold packing pieces in at least two locations within their length, the tension capacity per component should be obtained from:

$$\text{For bolted connections: } P_t = p_y (A_c - 0.25a_2) \quad (4.4)$$

$$\text{For welded connections: } P_t = p_y (A_g - 0.15a_2) \quad (4.5)$$

- b) If the components are both connected to the same side of a gusset or member, or not interconnected as given in a), the tension capacity per component should be taken as given in expressions (4.2) and 4.3).

4.3 Compression members

4.3.1 Introduction

In general, members in compression are susceptible to three possible overall buckling modes:

- flexural buckling, about either the major or the minor principal axis
- torsional buckling about the longitudinal axis
- torsional-flexural buckling.

The critical failure mode depends on the symmetry and dimensions of the cross-section, and also on the effective lengths of the member about the various axes. In conventional design of carbon steel hot rolled sections, only flexural buckling is critical for compression members because of the geometry and thickness of the section elements. In cold formed sections, however, the members may be weak in torsion owing to the thinness of the material. Thus, it is generally necessary to consider the effect of torsion in establishing the critical failure mode for members in compression.

Doubly symmetric cross-sections (CHS, RHS, I sections, etc.)

Doubly symmetric cross-sections need not be checked for torsional-flexural buckling since the shear centre coincides with the centroid of the cross-section.

Circular and square hollow sections will not fail by torsional-flexural or torsional buckling.

For the range of rectangular hollow section sizes typically used in construction, torsional buckling will not be critical. (Torsional buckling in rectangular hollow sections need only be considered for sections with unusually high D/B ratios.)

Singly symmetric cross-sections (angles, channels, etc.)

It is necessary to check sections such as single channels and angles for torsional-flexural buckling, as the shear centre does not coincide with the centroid of the cross-section.

Point symmetric cross-sections (Z-sections, cruciform sections, etc.)

Torsional buckling will be the critical buckling mode for these sections.

Note that slender sections which are not doubly symmetric should be checked for the additional bending moment caused by the shift in the neutral axis of the effective section (see Section 4.5.2).

4.3.2 Local capacity of the cross-section

The capacity of a cross-section subject to compression with a resultant acting through the centroid of the gross section (class 1, 2 or 3) or the effective section (class 4), P_{sq} , may be taken as:

$$P_{sq} = A_g p_y \quad \text{for class 1, 2 or 3 cross-sections} \quad (4.6)$$

$$P_{sq} = A_{eff} p_y \quad \text{for class 4 cross-sections} \quad (4.7)$$

where:

A_g is the gross cross-sectional area

A_{eff} is as defined in Section 3.8.4

p_y is as defined in Section 2.2.2.

4.3.3 Buckling of axially compressed members

The compression resistance of a member, P_c , may be taken as:

$$P_c = c b_c A_g p_y \quad (4.8)$$

where:

$b_c = 1$ for class 1, 2 or 3 cross-sections

$= A_{eff} / A_g$ for class 4 slender cross-sections

c is a reduction factor, which may be determined from either Figure 4.1 or Table 4.1.

In general, the reduction factor, c , depends on:

- the non-dimensional slenderness of the gross section, $\bar{\lambda}$
- whether the section is welded or cold formed
- the mode of buckling.

It can be seen from Table 4.1 and Figure 4.2 that different curves are applicable to the different modes of buckling. It is therefore necessary to calculate values for c for each buckling mode in order to determine which mode is critical.

The non-dimensional slenderness, \bar{I} is given by:

$$\bar{I} = \sqrt{\frac{P_{sq}}{P_E}} = \sqrt{\frac{\mathbf{b}_c A_g p_y}{P_E}} \quad (4.9)$$

where:

P_E is the elastic buckling load of the member in compression.

For buckling about the x - or y -axis (i.e. major or minor axis), P_E is given by P_x or P_y . For torsional buckling (about the longitudinal, z -axis) P_E is given by P_z and for torsional-flexural buckling it is given by P_{xz} .

Expressions for the elastic buckling load are:

$$P_x = \frac{\pi^2 E I_x}{L_{Ex}^2} \quad (4.10)$$

$$P_y = \frac{\pi^2 E I_y}{L_{Ey}^2} \quad (4.11)$$

$$P_z = \frac{1}{r_0^2} \left(\frac{\pi^2 E H}{L_{Ez}^2} + G J \right) \quad (4.12)$$

but for hollow sections, the warping constant H is small, so $P_z \approx \frac{G J}{r_0^2}$

$$P_{xz} = \frac{1}{2 \mathbf{b}} \left[(P_x + P_z) - \sqrt{(P_x + P_z)^2 - 4 \mathbf{b} P_x P_z} \right] \quad (4.13)$$

and

$$\mathbf{b} = 1 - \left(\frac{x_0}{r_0} \right)^2 \quad (4.14)$$

$$r_0 = \sqrt{r_x^2 + r_y^2 + x_0^2} \quad (4.15)$$

where:

P_x, P_y are the elastic flexural buckling loads of the member in compression about the x - and y - axes

P_z is the elastic torsional buckling load of the member in compression about the z -axis

P_{xz} is the elastic torsional flexural buckling load of the member in compression

r_x, r_y are the radii of gyration of cross-section about the x and y axes respectively

x_0 is the distance of shear centre from centroid of cross-section along the x -axis.

L_{Ex}, L_{Ey} are the effective lengths corresponding to buckling about the x - or y -axis

- L_{Ez} is the effective length corresponding to longitudinal twisting (for struts with concentric connections, L_{Ez} can conservatively be taken as the larger of L_x and L_y)
- G is the shear modulus which can be taken as 76,900 N/mm²
- H is the warping constant (which can be obtained from published tables or see below for flanged sections)
- J is the torsional constant (which can be obtained from published tables or see below for flanged sections).

The effective length L_E of a compression member with both ends effectively held in position laterally at the centroid may conservatively be taken as equal to its actual length. Alternatively, the effective length may be determined by reference to carbon steel rules in accordance with Table 22, BS 5950-1^[10].

For angles, the x and y axes should be taken as the u and v axes respectively. For mono-symmetric sections, the x -axis should be taken as the axis of symmetry (*this will not always be the principal major axis*) and the y -axis is the axis normal to the axis of symmetry (*this will not always be the principal minor axis*). For point-symmetric sections, the x -axis should be taken as the major principal axis.

Note that, for a flanged section, the warping constant, H and torsional constant J can be obtained from the expressions given in Figure 4.2.

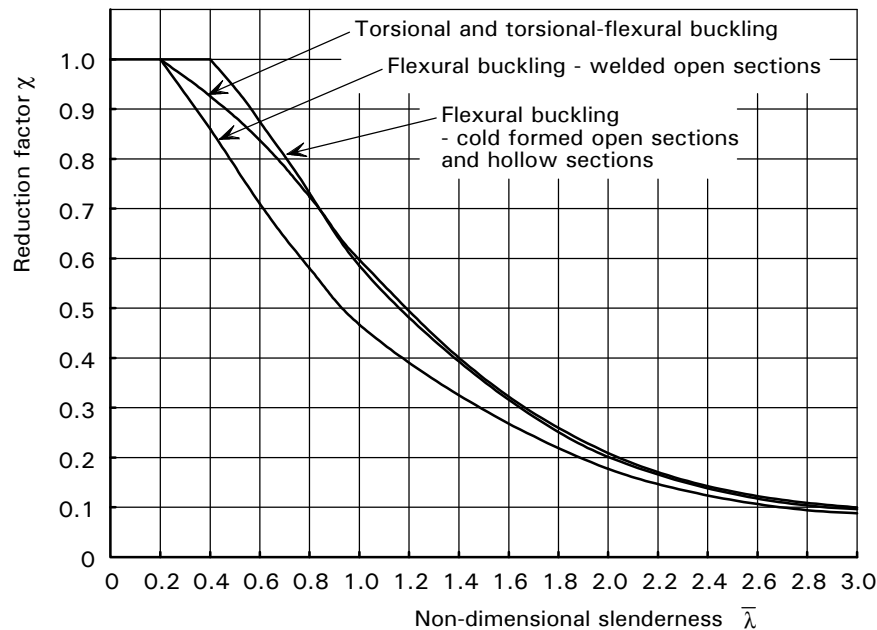

Figure 4.1 *Buckling curves for flexural, torsional and torsional-flexural buckling of compression members*

Table 4.1 Reduction factor c for buckling of compression members

\bar{I}	Buckling reduction factor χ		
	Flexural buckling		Torsional and torsional-flexural buckling
	Hollow sections and cold formed open sections	Welded open sections	
0.2	1.000	1.000	1.000
0.3	1.000	0.924	0.964
0.4	1.000	0.850	0.926
0.5	0.940	0.774	0.884
0.6	0.875	0.710	0.837
0.7	0.805	0.643	0.784
0.8	0.731	0.580	0.725
0.9	0.657	0.521	0.661
1.0	0.585	0.467	0.597
1.1	0.520	0.419	0.535
1.2	0.461	0.376	0.478
1.3	0.410	0.339	0.427
1.4	0.366	0.306	0.382
1.5	0.328	0.277	0.342
1.6	0.295	0.251	0.308
1.7	0.266	0.229	0.278
1.8	0.241	0.209	0.252
1.9	0.220	0.192	0.229
2.0	0.201	0.177	0.210
2.1	0.184	0.163	0.192
2.2	0.169	0.151	0.177
2.3	0.156	0.140	0.163
2.4	0.145	0.130	0.151
2.5	0.134	0.121	0.140
2.6	0.125	0.113	0.130
2.7	0.117	0.106	0.121
2.8	0.109	0.100	0.113
2.9	0.102	0.094	0.106
3.0	0.096	0.088	0.099

Note:

The buckling curves are derived from the following expressions:

$$\chi = \frac{1}{\varphi + [\varphi^2 - \bar{I}^2]^{0.5}} \leq 1 \quad \varphi = 0.5 (1 + \alpha(\bar{I} - \bar{I}_0) + \bar{I}^2)$$

α is the imperfection factor and \bar{I}_0 is the limiting slenderness

For hollow sections and cold formed open sections $\alpha=0.49$ and $\bar{I}_0=0.40$

For welded open sections $\alpha=0.76$ and $\bar{I}_0=0.20$

For torsional and torsional-flexural buckling (cold formed and welded sections) $\alpha=0.34$ and $\bar{I}_0=0.20$

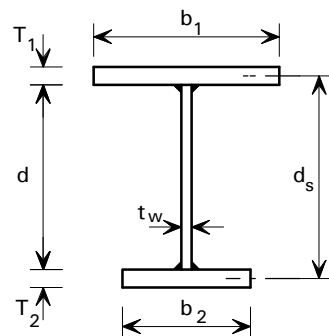

$$H = \frac{d_s^2 T_1 T_2 b_1^3 b_2^3}{12(T_1 b_1^3 + T_2 b_2^3)} \quad (4.16)$$

$$J = \frac{1}{3}(T_1^3 b_1 + T_2^3 b_2 + t_w^3 d) \quad (4.17)$$

Figure 4.2 Warping and torsional constants for asymmetrical plate girders

4.4 Members in bending

A member is in simple bending under loads acting normal to the longitudinal axis if it is connected in such a way that there is no tensile or compressive end loading and that the loads and reactions act through the shear centre (i.e. there is no twisting). The following criteria should be considered when designing a beam in simple bending:

- Yielding of the cross-section
- Local buckling (slender section only)
- Lateral-torsional buckling
- Shear capacity and shear buckling
- Local strength at points of loading or reaction
- Deflection at the Serviceability Limit State.

The effects of shear lag and flange curling may also have to be considered in design depending on the member geometry, see Sections 3.6 and 3.7.

For design of members subject to combined loading, see Section 4.5.

4.4.1 Cross-sections subject to shear

The shear capacity, P_v , of a cross-section may generally be taken as:

$$P_v = 0.6 p_y A_v \quad (4.18)$$

where:

A_v is the shear area, which may be calculated in accordance with BS 5950-1, clause 4.2.3 as:

- | | |
|---|-------------------|
| a) channel sections, load parallel to web | tD |
| b) welded I sections, load parallel to web | td |
| c) rectangular hollow sections, load parallel to webs | $A_g D / (D + B)$ |
| d) welded box sections, load parallel to webs | $2td$ |
| e) circular hollow sections | $0.6A_g$ |
| f) solid bars and plates | $0.9A_g$ |

A_g is the gross cross-sectional area

B , D , d and t are defined in Figure 3.2

p_y is as defined in Section 2.2.2.

In circular, square and rectangular hollow sections, the shear area should be assumed to be located adjacent to the neutral axis.

The resistance to shear buckling should be checked when $d/t \geq 39.5e$ (see Section 4.4.5).

4.4.2 Cross-sections subject to bending moment and low shear

Where the applied design shear force $F_v \leq 0.6 P_v$, the moment capacity, M_c , of a cross-section should be taken as:

$$\text{class 1 or class 2 cross-sections:} \quad M_c = p_y S \quad (4.19)$$

$$\text{class 3 cross-sections:} \quad M_c = p_y Z \quad (4.20)$$

$$\text{class 4 cross-sections:} \quad M_c = p_y Z_{\text{eff}} \quad (4.21)$$

where:

S is the plastic section modulus of the cross-section

Z is the elastic section modulus of the cross-section

Z_{eff} is the effective section modulus of a class 4 slender cross-section (see Section 3.8.4).

To avoid irreversible deformation at serviceability, the value of M_c for plastic and compact cross-sections should be limited to $1.2p_y Z$ for simply supported beams and cantilevers. For other cases, a general limit of $1.5p_y Z$ should be applied; a full explanation is given in the *Advisory Desk Note, AD195*^[24].

4.4.3 Cross-sections subject to bending moment and high shear

Where $F_v > 0.6 P_v$, the design moment capacity, M_c , of a cross-section should be taken as:

$$\text{class 1 or class 2 cross-sections:} \quad M_c = p_y (S - r S_v) \quad (4.22)$$

$$\text{class 3 cross-sections:} \quad M_c = p_y (Z - r S_v / 1.5) \quad (4.23)$$

$$\text{class 4 cross-sections:} \quad M_c = p_y (Z_{\text{eff}} - r S_v / 1.5) \quad (4.24)$$

$$\text{where} \quad r = [2(F_v / P_v) - 1]^2 \quad (4.25)$$

For sections with equal flanges, S_v is the plastic modulus of the shear area A_v . For sections with unequal flanges, S_v should be taken as the plastic modulus of the gross section less the plastic modulus of that part of the section remaining after deduction of the shear area.

4.4.4 Lateral-torsional buckling

The possibility of lateral-torsional buckling may be discounted in the following instances:

- where bending takes place about the minor axis only
- for circular and square hollow sections, and circular and square solid bars
- for beams laterally restrained throughout their length by adequate means
- where the lateral slenderness parameter $\bar{I}_{LT} < 0.4$ (see below).

In all other cases (i.e. in unrestrained beams subject to major axis moment M_x) every segment length between lateral restraints must satisfy the following conditions:

$$M_x \leq M_b / m_{LT} \quad \text{and} \quad M_x \leq M_{cx} \quad (4.26)$$

where:

M_{cx} is the moment capacity of the section from Section 4.4.2

M_b is the buckling resistance moment

m_{LT} is the equivalent uniform moment factor for lateral-torsional buckling. This takes account of the fact that the theory from which M_b is obtained assumes a uniform moment throughout the segment. Values of m_{LT} are given in Table 18 of BS 5950-1.

The buckling resistance moment, M_b is given by:

$$M_b = c_{LT} \beta_w S_x p_y \leq M_{cx} \quad (4.27)$$

where:

$b_w = 1$ for plastic or compact cross-sections

$= Z_x / S_x$ for semi-compact cross-sections

$= Z_{x,eff} / S_x$ for slender cross-sections.

c_{LT} is a reduction factor for lateral torsional buckling, which may be determined from either Figure 4.3 or Table 4.2.

The reduction factor c_{LT} depends on the non-dimensional slenderness of the beam, \bar{I}_{LT} and the type of section.

The non-dimensional slenderness \bar{I}_{LT} is defined as

$$\bar{I}_{LT} = \frac{I_{LT}}{\pi} \sqrt{\frac{p_y}{E}} \quad (4.28)$$

and I_{LT} is the equivalent slenderness, as defined in BS 5950-1, clause 4.3.6.7. The value of I_{LT} is given by:

$$I_{LT} = uvI \sqrt{b_w} \quad (4.29)$$

where:

$$I = L_E / r_y \quad (4.30)$$

L_E is the effective length for lateral torsional buckling, as defined in BS 5950-1, clause 4.3.5

r_y is the radius of gyration about the minor axis

u is the buckling parameter

v is the slenderness factor, as defined in BS 5950-1, clause 4.3.6.7.

Table 4.2 and Figure 4.3 show the buckling curves (c_{LT} versus \bar{I}_{LT}) for lateral torsional buckling. The imperfection factor a may be taken as 0.34 for cold formed sections and as 0.76 for welded sections. \bar{I}_0 should be taken as 0.4.

Note that for single angles, the applied moments should be resolved into moments about the principal u - and v -axes. Guidance on calculating λ_{LT} for single angles can be obtained from BS 5950-1, clause B.2.9. The angle will also need to be checked for the effects of biaxial bending in accordance with Section 4.5.

Table 4.2 Reduction factor c_{LT} for buckling of bending members

\bar{I}_{LT}	Buckling reduction factor χ_{LT}	
	Cold formed sections	Welded sections
0.2	1.000	1.000
0.3	1.000	1.000
0.4	1.000	1.000
0.5	0.957	0.910
0.6	0.908	0.822
0.7	0.851	0.737
0.8	0.785	0.656
0.9	0.713	0.582
1.0	0.639	0.515
1.1	0.568	0.457
1.2	0.503	0.406
1.3	0.446	0.362
1.4	0.396	0.324
1.5	0.354	0.292
1.6	0.317	0.263
1.7	0.285	0.239
1.8	0.258	0.217
1.9	0.234	0.199
2.0	0.213	0.182
2.1	0.195	0.168
2.2	0.179	0.155
2.3	0.165	0.143
2.4	0.152	0.133
2.5	0.141	0.124
2.6	0.131	0.116
2.7	0.122	0.108
2.8	0.114	0.101
2.9	0.107	0.095
3.0	0.100	0.090

Note:

The buckling curves are derived from the following expressions:

$$\chi_{LT} = \frac{1}{\phi_{LT} + [\phi_{LT}^2 - \bar{\lambda}_{LT}^2]^{0.5}} \leq 1 \quad \phi_{LT} = 0.5 \left(1 + \alpha(\bar{\lambda}_{LT} - \bar{\lambda}_0) + \bar{\lambda}_{LT}^2 \right)$$

α is the imperfection factor and \bar{I}_0 is the limiting slenderness

For cold formed sections $\alpha=0.34$ and $\bar{I}_0=0.40$

For welded sections $\alpha=0.76$ and $\bar{I}_0=0.40$

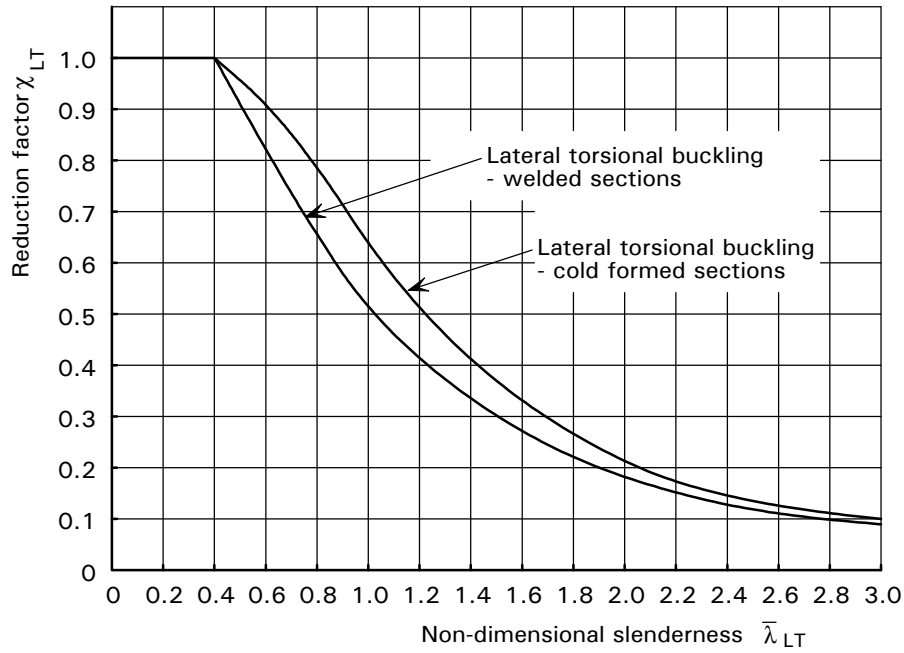

Figure 4.3 Buckling curves for lateral-torsional buckling

4.4.5 Shear buckling resistance of webs

Where the ratio $d/t \geq 17.1e\sqrt{k_t}$ for transversely stiffened webs, or $d/t \geq 39.5e$ for unstiffened webs, the shear capacity may be limited by the shear buckling resistance. The parameter k_t is defined in expressions (4.37) and (4.38) below.

The following approach for determining the shear buckling resistance is based on the guidance in Eurocode 3 Part 1.5^[25].

The shear buckling resistance V_b of a web may be obtained from:

$$V_b = (V_w + V_f), \quad \text{but} \quad V_b \leq P_v \quad (4.31)$$

where:

V_w is the simple shear buckling resistance

V_f is the flange-dependent shear buckling resistance (for simplicity, V_f can be neglected)

The simple shear buckling resistance, V_w , can be obtained from:

$$V_w = d t q_w \quad (4.32)$$

in which $q_w = c_w p_{yw} / \sqrt{3}$

where:

q_w is the shear buckling strength of the web

χ_w is a reduction factor for simple shear buckling resistance

d is the clear web depth between flanges (refer to the plate girder in Figure 3.2)

t is the thickness of the web

p_{yw} is the design strength of the web (p_y is as defined in Section 2.2.2).

For webs with transverse stiffeners at the supports, with or without intermediate transverse stiffeners, χ_w is related to the slenderness parameter \bar{I}_w as follows:

$$\bar{I}_w \leq 0.5, \quad c_w = 1.0 \quad (4.33)$$

$$\bar{I}_w > 0.5, \quad c_w = 0.11 + \frac{0.64}{\bar{I}_w} - \frac{0.05}{\bar{I}_w^2} \quad (4.34)$$

For webs with transverse stiffeners only at the supports, the slenderness parameter \bar{I}_w may be taken as:

$$\bar{I}_w = \left(\frac{d}{78.9 t e} \right) \quad (4.35)$$

For webs with transverse stiffeners at the supports and intermediate transverse stiffeners, the slenderness parameter \bar{I}_w may be taken as:

$$\bar{I}_w = \left(\frac{d}{34.2 t e \sqrt{k_t}} \right) \quad (4.36)$$

For webs with transverse stiffeners at the supports and at intermediate spacing a , such that the panel aspect ratio $a/d < 1$:

$$k_t = 4 + \frac{5.34}{(a/d)^2} \quad (4.37)$$

For webs with transverse stiffeners at the supports and at intermediate spacing a , such that the panel aspect ratio $a/d > 1$:

$$k_t = 5.34 + \frac{4}{(a/d)^2} \quad (4.38)$$

If the flange resistance is not completely utilized in withstanding the bending moment ($M < M_f$, where M is the applied moment and M_f is the moment capacity of the flanges alone), then a contribution V_f from the flanges may be included in the shear buckling resistance. For symmetric plate girders (without lippled flanges) this is obtained from:

$$V_f = \frac{(2b + t) T^2 p_{yf}}{c} \left[1 - \left[\frac{M}{M_f} \right]^2 \right] \quad (4.39)$$

where:

$$c = \left[0.17 + \frac{3.5(2b + t) T^2 p_{yf}}{t d^2 p_{yw}} \right] a \quad c/a \leq 0.65 \quad (4.40)$$

p_{yf} is the design strength of flange
 b and T are defined in Figure 3.2.

If an axial force F is also applied, the value of M_f should be reduced by a factor:

$$\left[1 - \frac{F}{[A_{f1} + A_{f2}] p_{yf}} \right] \quad (4.41)$$

where A_{f1} and A_{f2} are the areas of the flanges

4.4.6 Web bearing, crippling and buckling

Provided that the flanges are laterally restrained, the resistance of an unstiffened web to forces from concentrated loads or support reactions will be governed by one of three possible failure modes:

- bearing of the web close to the flange, accompanied by plastic deformation of the flange,
- crippling of the web, in the form of localised buckling and crushing of the web close to the flange, accompanied by plastic deformation of the flange,
- buckling of the web over most of the depth of the member.

For cold formed structural sections, the guidance in BS 5950-5, clause 5.3 for carbon steel can be adopted^[26].

For welded structural sections, the following approach should be adopted, based on the guidance in Eurocode 3 Part 1.5^[25].

The design transverse force, F_x should not exceed the resistance of the web to transverse forces, i.e.:

$$F_x \leq p_{yw} L_{\text{eff}} t \quad (4.42)$$

where L_{eff} is the effective length for resistance to transverse forces, and is a function of the stiff bearing length, b_1 and effective loaded length, l_y . L_{eff} is determined from the following rules that are applicable for welded girders provided that the flanges are held in position in the lateral direction either by their own stiffness or by bracings.

In addition the effect of the transverse force on the moment resistance of the member should be considered.

To determine L_{eff} , a distinction should be made between three types of force application, as follows:

- Forces applied through one flange and resisted by shear forces in the web (Figure 4.4, Type a).
- Forces applied to one flange and transferred through the web directly to the other flange (Figure 4.4, Type b).
- Forces applied through one flange close to an unstiffened end (Figure 4.4, Type c).

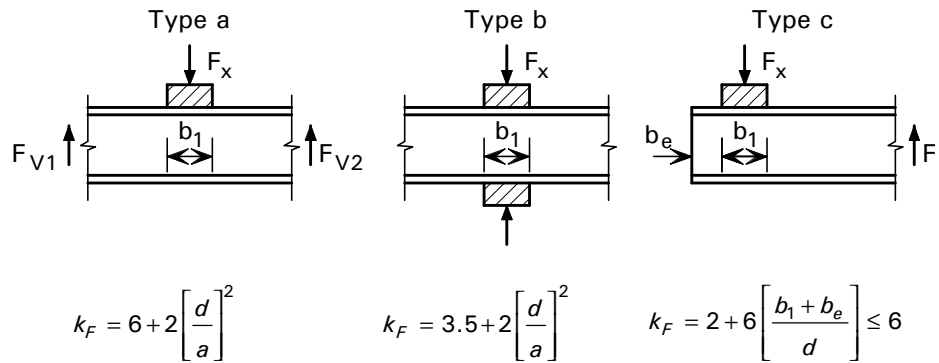

Figure 4.4 Buckling coefficients for different types of force application

Length of stiff bearing

The length of stiff bearing, b_1 , on the flange is the distance over which the applied force is effectively distributed and it may be determined by dispersion of load through solid steel material at a slope of 1:1, see Figure 4.5. However, b_1 should not be taken as larger than d .

If several concentrated loads are closely spaced, the resistance should be checked for each individual load as well as for the total load with b_1 as the centre-to-centre distance between outer loads.

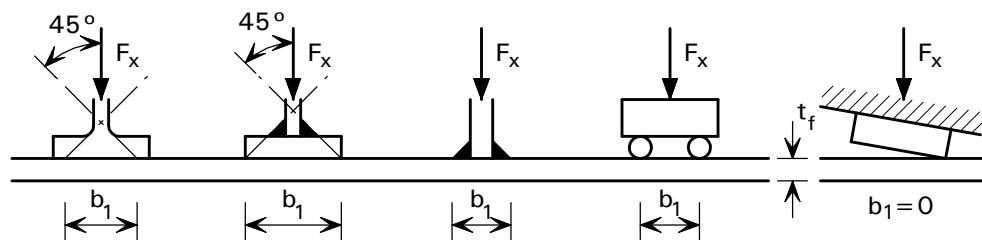

Figure 4.5 Length of stiff bearing, b_1

Effective loaded length

The effective loaded length l_y should be calculated using two dimensionless parameters m_1 and m_2 obtained from:

$$m_1 = \frac{p_{yf} (2b + t)}{p_{yw} t} \tag{4.43}$$

$$I_F > 0.5, \quad m_2 = 0.02 \left(\frac{d}{T} \right)^2 \tag{4.44}$$

$$I_F \leq 0.5, \quad m_2 = 0$$

For types a) and b) in Figure 4.4, l_y should be obtained using

$$l_y = b_1 + 2T \left[1 + \sqrt{m_1 + m_2} \right] \tag{4.45}$$

For type c) l_y should be obtained as the smaller of the expressions (4.45), (4.46) and (4.47). However, b_1 in expression (4.45) should be taken as zero if the

structure that introduces the force does not follow the slope of the girder, see Figure 4.5.

$$l_y = l_e + T \left[\sqrt{\frac{m_1}{2} + \left(\frac{l_e}{T}\right)^2} + m_2 \right] \quad (4.46)$$

$$l_y = l_e + T \sqrt{m_1 + m_2} \quad (4.47)$$

where l_e is given by

$$l_e = \frac{k_F E t^2}{2 p_{yw} d} \leq b_1 + b_e \quad (4.48)$$

Effective length of resistance

The effective length of resistance should be obtained from:

$$L_{\text{eff}} = c_F l_y \quad (4.49)$$

where:

$$c_F = \frac{0.5}{\lambda_F} \leq 1.0 \quad (4.50)$$

$$\lambda_F = \sqrt{\frac{l_y t p_{yw}}{F_{\text{cr}}}} \quad (4.51)$$

$$F_{\text{cr}} = 0.9 k_F E \frac{t^3}{d} \quad (4.52)$$

where:

k_F is the buckling coefficient for different types of force application (Figure 4.4)

l_y is the effective loaded length.

4.4.7 Transverse stiffeners

Transverse stiffeners at supports and at positions where significant external forces are applied should preferably be double-sided and symmetric about the centreline of the web. These stiffeners should be checked for cross-section crushing and buckling. Intermediate stiffeners not subject to external forces need only be checked for buckling.

The effective cross-section to be used in the buckling check should include a width of web plate either side of the stiffener equal to $11 \epsilon t$ but not greater than the actual width of web available (e.g. at the end of a member) nor greater than $0.5 a$ where a is the spacing of transverse stiffeners.

The buckling resistance of symmetric stiffeners may be determined from Section 4.3.3 using $\alpha = 0.76$, $\bar{I}_0 = 0.2$ and an effective length of not less than $0.75 d$, or more if appropriate for the conditions of restraint (e.g. for intermediate stiffeners not joined to both flanges). For single-sided or other asymmetric stiffeners the resulting eccentricity should be allowed for using Section 4.5.2.

At supports or at intermediate positions where significant loads are applied, the buckling resistance should at least be equal to the reaction or applied load.

At other intermediate positions, the compression force F_q in the stiffener may be calculated from:

$$F_q = F_v - V_w \quad (4.53)$$

where:

F_v is the shear force in the member

V_w is defined in Section 4.4.5.

The above expression should be evaluated ignoring the presence of the stiffener.

The second moment of area of an intermediate stiffener cross-section, I_{TS} should satisfy the following:

$$\text{For } a/d < \sqrt{2}, \quad I_{TS} \geq 1.5 d^3 t^3 / a^2 \quad (4.54)$$

$$\text{For } a/d \geq \sqrt{2}, \quad I_{TS} \geq 0.75 d t^3 \quad (4.55)$$

4.4.8 Deflection calculations

The deflection of elastic beams (i.e. those not containing a plastic hinge) may be estimated by standard structural theory, except that the secant modulus of elasticity appropriate to the stress level in the beam should be used instead of Young's modulus. The non-linear material stress-strain curve (Figure 2.1) implies that the stiffness of a stainless steel component varies with the stress level, the stiffness decreasing as the stress increases. Consequently, deflections are greater than those for carbon steels and it is necessary to use a reduced modulus to predict the behaviour of members in which high stresses occur. Using standard structural theory but with the secant modulus corresponding to the highest level of stress is a conservative method of estimating deflections.

For slender cross-sections and/or members subject to shear lag, an effective section should be used in the calculations. A first estimate would be to use the effective section based on the effective widths established in Section 3.8.4. This can be refined by using an effective section based on the actual stress in the elements by taking ϵ in Table 3.1 as:

$$e = \left(\frac{275}{f} \frac{E}{205,000} \right)^{0.5} \quad (4.56)$$

where

f is the actual stress in the element based on the effective cross-section.

The secant modulus, E_s , to be used in deflection calculations should be ascertained for the member with respect to the rolling direction. If the orientation is not known, or cannot be ensured, then the lesser value of E_s should be assumed. The value of the secant modulus may be obtained as follows:

$$E_s = \frac{E_{st} + E_{sc}}{2} \quad (4.57)$$

where E_{st} and E_{sc} are the secant moduli corresponding to the stress in the tension flange and compression flange respectively.

Values of E_{st} and E_{sc} for a given stress ratio may be read from Table 4.4 using linear interpolation as necessary. Alternatively, values of the secant moduli E_{st} and E_{sc} for the appropriate orientation and stress ratio can be estimated from the following equation using the constants given in Table 4.3.

$$E_{st} = \frac{E}{1 + k \left(\frac{f_t}{p_y} \right)^{n-1}} \quad E_{sc} = \frac{E}{1 + k \left(\frac{f_c}{p_y} \right)^{n-1}} \quad (4.58)$$

where:

f_t and f_c are the actual values of stress, f , in the tension and compression flange respectively

$$E = 200,000 \text{ N/mm}^2$$

$$k = 0.002 \frac{E}{p_y} \quad (4.59)$$

Table 4.3 Values of constants to be used for determining secant moduli

Grade	p_y N/mm ²	k	n	
			Longitudinal direction	Transverse direction
1.4301 (304)	210	1.90		
1.4307 (304L)	200	2.00	6.5	8.5
1.4541 (321)	200	2.00		
1.4401 (316)	220	1.82		
1.4404 (316L)	220	1.82	7.0	9.0
1.4571 (320)	220	1.82		
1.4462 (2205)	460	0.87	5.0	5.0

Note:
It is conservative to use the values for n corresponding to the longitudinal direction.

Table 4.4 Secant modulus E_s for deflection calculations

Stress ratio (f/p_y)	Secant modulus E_s (kN/mm ²)				
	Grade 1.4301 (304)		Grade 1.4401 (316)		Grade 1.4462 (duplex 2205)
	Longitudinal direction	Transverse direction	Longitudinal direction	Transverse direction	
0.00	200	200	200	200	200
0.20	200	200	200	200	200
0.25	200	200	200	200	199
0.30	199	200	200	200	199
0.35	199	200	199	200	197
0.40	198	200	199	200	196
0.42	197	199	198	200	195
0.44	196	199	197	199	194
0.46	195	199	197	199	193
0.48	193	198	196	199	191
0.50	192	198	194	199	190
0.52	190	197	193	198	188
0.54	188	196	191	197	186
0.56	185	195	189	197	184
0.58	183	194	187	195	182
0.60	179	192	184	194	180
0.62	176	190	181	192	177
0.64	172	187	178	190	175
0.66	168	184	174	188	172
0.68	163	181	170	185	169
0.70	158	177	165	181	165
0.72	152	172	160	177	162
0.74	147	167	154	172	159
0.76	141	161	148	166	155

Note: f is the (unfactored) SLS stress

4.5 Members subject to combined loading

4.5.1 Axial tension and bending

Tension members with moments should be checked for resistance to lateral torsional buckling in accordance with Section 4.4.4 under the moment alone. They should also be checked for capacity under the combined effects of axial load and moment at the points of maximum bending moment and axial load. The following relationship should be satisfied (this check is in accordance with BS 5950-1, clause 4.8.2.2):

$$\frac{F_t}{A_e p_y} + \frac{M_x}{M_{cx}} + \frac{M_y}{M_{cy}} \leq 1 \quad (4.60)$$

where:

F_t is the axial tensile load in the member at the critical location

A_e is the effective net area (see Section 3.4)

M_x is the moment about the major axis at the critical section

M_{cx} is the moment capacity about the major axis in the absence of axial load (Sections 4.4.2 and 4.4.3)

M_y is the moment about the minor axis at the critical section

M_{cy} is the moment capacity about the minor axis in the absence of axial load (Sections 4.4.2 and 4.4.3).

Alternatively, the more exact method in BS 5950-1, clause 4.8.2.3 can be applied for class 1 and class 2 cross-sections.

4.5.2 Axial compression and bending

Compression members with moments should be checked for local capacity at the points of greatest bending moment and axial load. The member should also be checked for overall buckling.

The following relationship should be satisfied (local capacity check):

For plastic, compact and semi-compact sections:

$$\frac{F_c}{A_g p_y} + \frac{M_x}{M_{cx}} + \frac{M_y}{M_{cy}} \leq 1 \quad (4.61)$$

For slender sections:

$$\frac{F_c}{A_{\text{eff}} p_y} + \frac{M_x + F_c e_x}{M_{cx}} + \frac{M_y + F_c e_y}{M_{cy}} \leq 1 \quad (4.62)$$

where:

e_x and e_y are the shifts in the neutral axis of the effective cross-section when the cross-section is subject to uniform compression (Figure 8.2). For doubly symmetric slender cross-sections, both e_x and e_y are zero.

A_{eff} is the effective cross-sectional area from 3.8.4

A_g is the gross cross-sectional area

F_c is the axial compressive load in the member at the critical location

M_x , M_y , M_{cx} and M_{cy} are as defined in Section 4.5.1 (see Section 4.4.2 and 4.4.3 for determination of M_{cx} and M_{cy}).

In addition, the combined effects of compressive loads and bending moments should be checked in accordance with the following equations to prevent major and minor axis buckling and lateral torsional buckling:

(a) For plastic, compact or semi-compact sections

$$\frac{F_c}{P_c} + \frac{m_x M_x}{p_y Z_x} + \frac{m_y M_y}{p_y Z_y} \leq 1 \quad (4.63)$$

$$\frac{F_c}{P_{c1}} + \frac{m_{LT} M_{LT}}{M_b} + \frac{m_y M_y}{p_y Z_y} \leq 1 \quad (4.64)$$

(b) For slender sections

$$\frac{F_c}{P_c} + \frac{m_x M_x + F_c e_x}{p_y Z_{x \text{ eff}}} + \frac{m_y M_y + F_c e_y}{p_y Z_{y \text{ eff}}} \leq 1 \quad (4.65)$$

$$\frac{F_c}{P_{c1}} + \frac{m_{LT} M_{LT} + F_c e_x}{M_b} + \frac{m_y M_y + F_c e_y}{p_y Z_{y \text{ eff}}} \leq 1 \quad (4.66)$$

where:

- M_b is the buckling resistance from 4.4.4
- M_{LT} is the maximum major axis moment in the segment length L governing M_b
- M_x is the maximum major axis moment in the segment length L_x governing P_{cx}
- M_y is the maximum minor axis moment in the segment length L_y governing P_{cy}
- P_c is the smallest of P_{cx} , P_{cy} , P_{cz} and P_{cxz} (see Section 4.3.3)
- P_{c1} is the smallest of P_{cy} , P_{cz} and P_{cxz}
- m_x , m_y and m_{LT} are equivalent uniform moment factors which should be based upon the pattern of moments over the relevant segment length
- m_{LT} is the equivalent uniform moment factor relating to the pattern of major axis moment over the segment length L_{LT} governing M_b and is obtained from Table 18 in BS 5950-1
- m_x is the equivalent uniform moment factor relating to the pattern of major axis moment over the segment length L_x governing P_{cx} and obtained from Table 26 in BS 5950-1
- m_y is the equivalent uniform moment factor relating to the pattern of minor axis moment over the segment length L_y governing P_{cy} and obtained from Table 26 in BS 5950-1
- L_{LT} is the segment length between restraints against lateral-torsional buckling
- L_x is the segment length between restraints against flexural buckling about the major axis
- L_y is the segment length between restraints against flexural buckling about the minor axis
- e_x and e_y are as defined above.

Alternatively, the more exact methods in BS 5950-1, clauses 4.8.3.3.2 and 4.8.3.3.3 can be applied.

4.5.3 Biaxial bending

Members subject to moments about both axes in the absence of tensile or compressive axial force should be designed in accordance with 4.5.2 taking values of F_c as zero.

5 DESIGN OF CONNECTIONS

5.1 Design considerations and assumptions

The design of stainless steel connections requires particular attention to maintain optimum corrosion resistance for connections that may become wet. The use of carbon steel bolts with stainless steel structural elements should always be avoided.

In situations where the connection is likely to be exposed to moisture, provision should be made to isolate carbon steel and stainless steel elements to prevent bimetallic corrosion. In welded connections involving carbon and stainless steels, it is generally recommended that any paint system applied to the carbon steel should extend over the weldment and onto the stainless steel by a few centimetres.

The general principles of good detailing practice applicable to carbon steels also apply to stainless steels and connections should be designed for ease of fabrication, erection and requirements for subsequent inspection and maintenance.

Where a connection is subject to impact, vibration, or frequent reversal of significant stress, welding is the preferred method of joining. These connections should also be checked for the effects of fatigue.

5.2 Bolted connections

5.2.1 General

The recommendations of Section 5.2 apply to connections with bolts in clearance holes where shear, tension or a combination of shear and tension is to be carried. It is good practice to provide washers under both the bolt head and the nut.

Shear forces are transferred by bearing between the bolts and the connected parts. Reliance on shear resistance by frictional forces, as in the case of friction grip bolted joints used in carbon steel structures, should be avoided in stainless steel (see Section 5.4). The strength of a connection is to be taken as the lesser of the strength of the connected parts and that of the fasteners.

Holes can be formed by drilling or punching. However, punching may introduce crevices that can increase the susceptibility to localised corrosion in corrosive environments.

The maximum clearances in standard holes are:

- 1 mm for M12 and M14 bolts (M14 is non standard)
- 2 mm for M16 to M24 bolts
- 3 mm for M27 and larger bolts

The following limitations on edge distance, end distance and bolt spacing should be observed (Figure 5.1 defines the notation):

$$1.4D \leq e_1 \leq \text{the lesser of } 11\epsilon t \text{ and } 150 \text{ mm}$$

$$kD \leq e_2 \leq \text{the lesser of } 11\epsilon t \text{ and } 150 \text{ mm}$$

$$p_1 \geq 2.5d$$

$$p_2 \geq 3.0d$$

where:

t is the thickness of the thinner outside ply

d is the nominal diameter of the bolt

D is the diameter of the hole

$k = 1.4$ for a sheared or hand flame cut edge

$k = 1.25$ for a rolled, machine flame cut, sawn or planed edge.

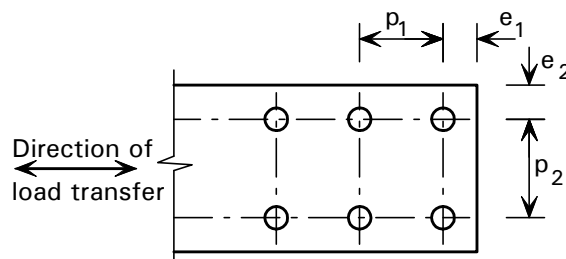

Figure 5.1 Edge distance, end distance and bolt spacing

These minimum distances are specified to prevent plate tearout and to allow sufficient clearance for tools to install the bolts. The limits are broadly consistent with BS 5950-1^[10]. The maximum spacing of bolts in any direction should be such that local compressive buckling of the plies is prevented. The guidance in BS 5950-1, clause 6.2.1.2 may be followed.

Block shear failure through a group of bolt holes at a free edge should be prevented by following the guidance in BS 5950-1, clause 6.2.4. This mode of failure consists of failure in shear at the row of bolt holes along the shear face of the hole group, accompanied by tensile rupture along the line of bolt holes on the tension face of the hole group. It is rarely critical for standard types of details.

5.2.2 Design strength

(a) Shear capacity

The shear capacity of a bolt, P_{sb} , should be taken as:

$$P_{sb} = p_{sb} A_s \quad (5.1)$$

where:

p_{sb} is the shear strength of bolt

$$= 0.48 U_{sb} \leq 0.69 Y_{0.2b} \text{ for property class 50, 70 and 80 bolts and other stainless steel bolts where } U_{sb} \leq 800 \text{ N/mm}^2$$

$$= 0.4 U_{sb} \text{ for stainless steel bolts where } 800 < U_{sb} \leq 1000 \text{ N/mm}^2$$

U_{sb} is the specified minimum tensile strength of the bolt

$Y_{0.2b}$ is the specified minimum stress at 0.2% permanent strain of the bolt

A_s is the shear area, usually taken as the tensile stress area, unless it can be guaranteed that the threaded portion will be excluded from the shear plane, in which case it can be taken as the unthreaded shank area.

Values for U_{sb} and $Y_{0.2b}$ are given in Table 2.3.

(b) **Bearing capacity**

The effective capacity of a bolt in bearing should be taken as the lesser of the bearing capacity of the bolt, P_{bb} , and the bearing capacity of the connected ply, P_{bs} , given by:

$$P_{bb} = d t_p p_{bb} \quad (5.2)$$

$$P_{bs} = d t_p p_{bs} \leq 0.5 e_1 t_p p_{bs} \quad (5.3)$$

where:

t_p is the thickness of the connected ply

p_{bb} is the bearing strength of the bolt = $0.72 (U_{sb} + Y_{0.2b})$

p_{bs} is the bearing strength of connected parts = $0.65 (U_s + p_y)$

U_s is the specified minimum tensile strength of the connected ply, given in Table 2.2

p_y is the design strength of the connected ply, defined in Section 2.2.2

d and e_1 are defined in Section 5.2.1.

(c) **Tension capacity**

The tensile force per bolt F_t transmitted by the connection should not exceed the nominal tension capacity P_{nom} of the bolt. P_{nom} can be determined from the following 'simple' method, where the prying force need not be calculated:

$$P_{nom} = 0.8 p_t A_t \quad (5.4)$$

where:

p_t is the tension strength of the bolt = $0.7 U_{sb} \leq Y_{0.2b}$

A_t is the tensile stress area as specified in the appropriate bolt standard. For bolts where the tensile stress area is not defined, A_t should be taken as the area at the bottom of the threads.

Note that this method may only be used if the connection satisfies both of the following:

- the cross-centre spacing of the bolt-lines, s should not exceed 55% of the flange width or end-plate width (Figure 5.2)
- if a connected part is designed assuming double curvature bending, its moment capacity per unit width should be taken as $p_y t_p^2/6$, where t_p is the thickness of the connected part.

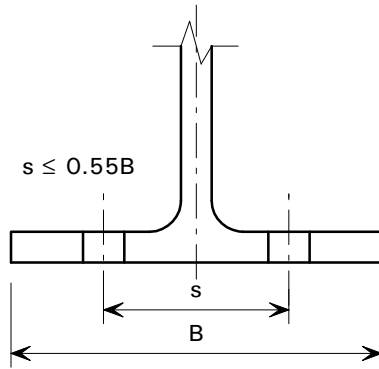

Figure 5.2 *Maximum cross-centres of bolt lines for the simple method of calculating P_{nom} (no explicit determination of prying forces)*

Alternatively, a more exact method given in BS 5950-1, clause 6.3.4.3 may be followed, which involves a calculation of the prying force.

The tensile capacity for tie bars and long stud bolts not subject to prying forces may be increased by removing the 0.8 factor in expression (5.4) (i.e. $P_{nom} = p_t A_t$).

The thread on the stud bolts or tie bars should comply with BS ISO 68-1^[27], BS ISO 261^[28] and BS ISO 262^[29].

(d) Combined shear and tension

When bolts are subject to both shear and tension, the following relationship should be satisfied in addition to (a), (b) and (c) above:

$$\frac{F_s}{P_{sb}} + \frac{F_t}{P_{nom}} \leq 1.4 \quad (5.5)$$

where:

F_s is the shear force

F_t is the tension force

(e) Design strengths for commonly used bolts

Table 5.1 gives the shear, bearing and tension strengths of stainless steel bolts. Table 5.2 gives the bearing strength of connected parts for common austenitic grades for bolts in clearance holes. Table 5.3 gives shear and tension capacities of M12 to M24 bolts in clearance holes (values for tension are calculated by the simple method and thus include a 20% allowance for prying forces).

Table 5.1 *Strengths of bolts in clearance holes*

Bolt grade (BS EN ISO 3506)	Property class (BS EN ISO 3506)	Shear strength p_{sb} (N/mm ²)	Bearing strength p_{bb} (N/mm ²)	Tension strength p_t (N/mm ²)
A1, A2 and A4	50	145	511	210
	70	311	828	450
	80	384	1008	560

Table 5.2 *Bearing strength of connected parts*

Grade of connected part	Bearing strength of connected parts for ordinary bolts in clearance holes, p_{bs} , (N/mm ²)
1.4307 (304L)	468
1.4301 (304)	475
1.4401 and 1.4404 (316 and 316L)	488

Table 5.3 *Shear and tension capacities of bolts in clearance holes*

Bolt size	Property class (BS EN 3506)	Shear capacity ⁽¹⁾	Tension capacity ⁽²⁾
		P_{sb} (kN)	P_{nom} (kN)
M12	50	12.2	14.2
	70	26.2	30.3
	80	32.4	37.8
M16	50	22.7	26.4
	70	48.7	56.5
	80	60.3	70.3
M20	50	35.5	41.2
	70	76.1	88.2
	80	94.1	109.8
M24	50	51.1	59.3
	70	109.6	127.1
	80	135.6	158.1

Notes:

(1) The shear area, A_s has been taken as the tensile stress area of the bolt, A_t .

(2) The tension capacity is as given by expression (5.4) and thus includes a 20% allowance for prying.

5.2.3 Long joints, large grip lengths and thick packing

For splices of unusual length (say 500 mm upwards), or when the grip length (i.e. the total thickness of the connected plies) exceeds 5 bolt diameters, or the thickness of packing exceeds $d/3$, the shear capacity might be reduced. In the absence of data for stainless steel, it is recommended to use the carbon steel rules for these situations (e.g. BS 5950-1, clauses 6.3.2.5 and 6.3.2.3 and 6.3.2.2).

5.3 Pin connections

The guidance given in BS 5950-1, clause 6.5 is applicable.

5.4 Preloaded bolts

HSFG stainless steel bolts are not generally available. If stainless steel bolts are highly torqued, galling can be a problem (see Section 7.6). Stainless steel connections should not be designed as slip resistant unless acceptability in the particular application can be demonstrated by test.

5.5 Securing nuts against vibration

To prevent bolt assemblies from becoming loose when subject to continued vibration, lock nuts are effective solutions. Several proprietary locking devices for nuts are available.

5.6 Welded connections

5.6.1 General

The following recommendations apply to full and partial penetration butt welds and to fillet welds made by an arc welding process.

Intermittent fillet welds and intermittent partial penetration butt welds should only be used where crevice corrosion is unlikely to occur. Furthermore, continuous partial penetration butt welds should be used with care in marine or very heavily polluted onshore environments, particularly where capillary action might occur.

5.6.2 Fillet welds

The angle of intersection of members connected by fillet welds should be such that the angle between the fusion faces of a weld is not less than 60° and not more than 120° . Outside these limits, the adequacy of the connection should be determined on the basis of tests. As for carbon steel (see BS 5950-1, clause 6.7.2.5), a single fillet weld should not be used in situations that produce a bending moment about the longitudinal axis of the weld if this causes tension at the root of the weld.

The effective length of a fillet weld may be taken as the overall length of the full-size fillet less one leg length, s , for each end which does not continue round a corner. However, a fillet weld with an effective length less than $4s$ or less than 40 mm should not be used to carry load.

The effective throat size, a , of a fillet weld should be taken as the perpendicular distance from the root of the weld to a straight line joining the fusion faces that lies within the cross-section of the weld.

The force per unit length transmitted by a fillet weld at a given point in its length should be determined from the applied forces and moments, using the elastic section properties of the weld or weld group, based on effective throat sizes. The design stress in a fillet weld should be calculated as the force per unit length transmitted by the weld, divided by the effective throat size a .

The capacity should be taken as sufficient if, throughout the length of the weld, the vector sum of the design stresses due to all forces and moments transmitted by the weld does not exceed its design strength p_w .

The design strength of the weld p_w should be taken as:

$$p_w = 0.5 U_e \quad \text{but not more than the lesser of } 0.46 U_s \text{ and } p_y \quad (5.6)$$

where:

U_s is the specified minimum ultimate tensile strength of the weaker part joined

U_e is the minimum tensile strength of the electrode, as specified in the relevant product standard

Note that the above value of 0.46 is slightly different from the value in BS 5950-1 and is based on the Euro Inox *Design Manual for Structural Stainless Steel*^[23].

For austenitic stainless steel electrodes, typical values of U_e lie between 510 and 550 N/mm², so the weld strength will be governed by the lesser of 0.46 U_s and p_y .

As an alternative, the directional method given in BS 5950-1, clause 6.8.7.3 can be used. In this method the forces per unit length transmitted by the weld are resolved into a longitudinal shear parallel to the axis of the weld and a resultant transverse force perpendicular to this axis. This method permits an enhancement in the transverse weld capacity of up to 25%.

5.6.3 Butt welds

The design strength of a full penetration butt weld may be taken as equal to the design strength of the weaker of the parts joined, provided that the weld satisfies the recommendations of Section 5.6.1. Guidance on throat size of partial penetration butt welds in BS 5950-1, clause 6.9.2 is applicable.

6 FIRE RESISTANT DESIGN

6.1 General

This Section deals with the design of stainless steel structures that, for reasons of general fire safety, are required to fulfil certain functions, in terms of avoiding premature collapse of the structure (load bearing function), when exposed to fire. The recommendations are only concerned with passive methods of fire protection and are applicable to stainless steel grades and structures that are generally designed within the rules of Sections 1 to 5 of this document. The method is based on the current draft of the Eurocode for structural steel fire design, prEN 1993-1-2^[30].

Austenitic stainless steels generally retain a higher proportion of their room temperature strength than carbon steels above temperatures of about 550°C, and a higher proportion of their stiffness at all temperatures.

Table 6.1 gives the load factors for the fire limit state, which are taken from BS 5950-8^[11].

Table 6.1 *Load factors for the fire limit state according to BS 5950-8*

Load	Load factor
Dead load	1.00
Imposed loads:	
<i>Permanent:</i>	
• those specifically allowed for in design, e.g. plant, machinery and fixed partitions	1.00
• in storage buildings or areas used for storage in other buildings (including libraries and designated filing areas)	1.00
<i>Non-permanent:</i>	
• in escape stairs and lobbies	1.00
• all other areas (imposed snow loads on roofs may be ignored)	0.80
Wind loads	0.33

The performance requirements of a stainless steel structure that may be subjected to accidental fire loading are no different from those of carbon steel, namely:

- Where mechanical resistance is required at the fire limit state, the structure should be designed and constructed in such a way that it maintains its load bearing function during the relevant fire exposure.
- Deformation criteria should be applied where the means of fire protection, or the design criteria for separating elements, require the deformation of the load bearing structure to be considered. However, it is not necessary to consider the deformation of the load bearing structure if the fire resistance of both the separating and load bearing elements is based on the standard fire curve.

6.2 Mechanical properties at elevated temperatures

Table 6.2 gives strength and stiffness retention factors relative to the values at 20°C for the stress-strain relationship and the parameter $g_{2,\theta}$ for four grades of stainless steel at elevated temperatures. The factors are defined below:

$k_{p0.2\text{proof},\theta}$ 0.2% proof strength at temperature q relative to design strength at 20°C, i.e. $p_{0.2\text{proof},\theta} / p_y$

$g_{2,\theta}$ a parameter used to calculate $p_{2,\theta}$, the strength at 2% total strain at temperature q , using the following expression:

$$p_{2,\theta} = p_{0.2\text{proof},\theta} + g_{2,\theta} (U_{s,\theta} - p_{0.2\text{proof},\theta}) \quad (6.1)$$

$k_{U,\theta}$ ultimate strength at temperature q relative to ultimate strength at 20°C, i.e. $U_{s,\theta} / U_s$

$k_{E,\theta}$ slope of linear elastic range at temperature q relative to slope at 20°C, i.e. E_θ / E

where:

E is Young's modulus at 20°C (= 200,000 N/mm²)

p_y is the design strength at 20°C, as defined in Section 2.2.2

U_s is the specified minimum tensile strength at 20°C, as given in Table 2.2.

In determining the structural fire resistance of stainless steel members of classes 1, 2 and 3, the strength at 2% total strain, $p_{2,\theta}$, is used in place of the design strength at ambient temperature, p_y .

However, in situations which require consideration of the deformation criteria, the strength at a total strain of 1.0%, $p_{1,\theta}$ is recommended as a basis for the calculations instead of $p_{2,\theta}$. The value of $p_{1,\theta}$ should be calculated using the following relationship:

$$p_{1,\theta} = p_{0.2\text{proof},\theta} + 0.5 g_{2,\theta} (U_{s,\theta} - p_{0.2\text{proof},\theta}) \quad (6.2)$$

For class 4 slender stainless steel sections, the elevated temperature 0.2% proof strength values, $p_{0.2\text{proof},\theta}$ should be used. Values for $p_{0.2\text{proof},\theta}$ are given relative to the yield strength at 20°C by the factor $k_{p0.2\text{proof},\theta}$ in Table 6.2.

Table 6.2 Retention factors for strength and stiffness and parameter $g_{2,\theta}$ at elevated temperature

Temperature q (°C)	Retention factor $k_{p, 0.2\text{proof}^\theta}$	Parameter $g_{2,q}$	Retention factor $k_{U,q}$	Retention factor $k_{E,q}$
Grade 1.4301 (304)				
20	1.00	0.26	1.00	1.00
100	0.82	0.24	0.87	0.96
200	0.68	0.19	0.77	0.92
300	0.64	0.19	0.73	0.88
400	0.60	0.19	0.72	0.84
500	0.54	0.19	0.67	0.80
600	0.49	0.22	0.58	0.76
700	0.40	0.26	0.43	0.71
800	0.27	0.35	0.27	0.63
900	0.14	0.38	0.15	0.45
1000	0.06	0.40	0.07	0.20
1100	0.03	0.40	0.03	0.17
1200	0.00	0.40	0.00	0.00
Grade 1.4401 (316)				
20	1.00	0.24	1.00	1.00
100	0.88	0.24	0.93	0.96
200	0.76	0.24	0.87	0.92
300	0.71	0.24	0.84	0.88
400	0.66	0.21	0.83	0.84
500	0.63	0.20	0.79	0.80
600	0.61	0.19	0.72	0.76
700	0.51	0.24	0.55	0.71
800	0.40	0.35	0.34	0.63
900	0.19	0.38	0.18	0.45
1000	0.10	0.40	0.09	0.20
1100	0.06	0.40	0.06	0.17
1200	0.00	0.40	0.00	0.00
Grade 1.4362 (SAF 2304)				
20	1.00	0.35	1.00	1.00
100	0.82	0.35	0.87	0.96
200	0.68	0.32	0.78	0.92
300	0.63	0.30	0.78	0.88
400	0.61	0.28	0.74	0.84
500	0.61	0.30	0.68	0.80
600	0.36	0.33	0.44	0.76
700	0.25	0.40	0.32	0.71
800	0.15	0.41	0.16	0.63
900	0.07	0.45	0.10	0.45
1000	0.02	0.47	0.05	0.20
1100	0.01	0.47	0.03	0.17
1200	0.00	0.47	0.00	0.00
Grade 1.4462 (2205)				
20	1.00	0.35	1.00	1.00
100	0.91	0.35	0.93	0.96
200	0.80	0.32	0.85	0.92
300	0.75	0.30	0.83	0.88
400	0.72	0.28	0.82	0.84
500	0.65	0.30	0.71	0.80
600	0.56	0.33	0.57	0.76
700	0.37	0.40	0.38	0.71
800	0.26	0.41	0.29	0.63
900	0.10	0.45	0.12	0.45
1000	0.03	0.47	0.04	0.20
1100	0.02	0.47	0.02	0.17
1200	0.00	0.47	0.00	0.00

6.3 Thermal properties at elevated temperatures

6.3.1 Thermal elongation

The thermal elongation of austenitic stainless steel $\Delta l/l$ may be determined from the following:

$$\Delta l/l = (16 + 4.79 \times 10^{-3} q - 1.243 \times 10^{-6} q^2) \times (q - 20) \times 10^{-6} \quad (6.3)$$

where:

- l is the length at 20°C
- Δl is the temperature induced expansion
- q is the steel temperature [°C].

6.3.2 Specific heat

The specific heat of stainless steel c_s may be determined from the following:

$$c_s = 450 + 0.280q - 2.91 \times 10^{-4} q^2 + 1.34 \times 10^{-7} q^3 \text{ J/kg°C} \quad (6.4)$$

where:

- q is as defined in Section 6.3.1

6.3.3 Thermal conductivity

The thermal conductivity of stainless steel l may be determined from the following:

$$l = 14.6 + 1.27 \times 10^{-2} q \text{ W/m°C} \quad (6.5)$$

where:

- q is as defined in Section 6.3.1.

6.4 Determination of structural fire resistance

Structural fire resistance may be determined either by testing or by the following calculation method.

6.4.1 Cross-section classification

In fire design, the method of classification of cross-sections described in Section 3 of this publication should be adopted, using ambient temperature design properties.

6.4.2 Tension members

The design capacity $P_{t,\theta}$ of a tension member at a uniform temperature q is given by:

$$P_{t,\theta} = k_{p2,\theta} P_t \quad (6.6)$$

where:

- $k_{p2,\theta} = p_{2,\theta}/p_y$ i.e. the retention factor for the strength at 2% total strain at temperature q (see Section 6.2)
- P_t is the tension capacity of the cross-section at ambient temperature according to Section 4.2.

Where the temperature in the member is non-uniform, the capacity is given by:

$$P_{t,\theta,n} = \sum_{i=1}^n A_i k_{p2,\theta,i} p_y \quad (6.7)$$

where:

A_i is the area of the i th element of the cross-section, which is at temperature q_i

$k_{p2,\theta,i}$ is the retention factor for the strength at 2% total strain at temperature q_i (see Section 6.2).

6.4.3 Compression members

The following recommendations apply to cross-sections that are:

- cold formed, open cross-sections (not welded), e.g. channels or angles, or
- cold formed hollow cross-sections (seam welded or seamless), e.g. circular or rectangular hollow sections.

The compression resistance $P_{c,\theta}$ of a compression member at a uniform temperature q is given by:

$$P_{c,\theta} = \chi_\theta A_g k_{p2,\theta} p_y \quad \text{for class 1, 2 or 3 cross sections} \quad (6.8)$$

$$P_{c,\theta} = \chi_\theta A_{\text{eff}} k_{p0.2\text{proof},\theta} p_y \quad \text{for class 4 cross-sections} \quad (6.9)$$

where:

χ_θ is the reduction factor for flexural buckling in fire, determined from Table 6.3

$k_{p2,\theta}$ and $k_{p0.2\text{proof},\theta}$ are retention factors at temperature q

The non-dimensional slenderness \bar{I}_q at temperature q is given by:

$$\bar{I}_\theta = \bar{I} [k_{p2,\theta} / k_{E,\theta}]^{0.5} \quad \text{for class 1, 2 or 3 cross sections} \quad (6.10)$$

$$\bar{I}_\theta = \bar{I} [k_{p0.2\text{proof},\theta} / k_{E,\theta}]^{0.5} \quad \text{for class 4 cross-sections} \quad (6.11)$$

where:

$k_{E,\theta}$ is the retention factor for the slope of the linear elastic range at temperature q (see Section 6.2)

In the absence of any guidance on the behaviour of members failing by torsional or torsional-flexural buckling in fire, it is recommended that the reduction factor for flexural buckling is also used for torsional and torsional-flexural buckling.

Table 6.3 *Buckling reduction factors for compression and bending members of cold formed sections in fire*

\bar{I}_θ or $\bar{I}_{LT,\theta}$	<i>Buckling reduction factor χ_q or $\chi_{LT,q}$</i>			
	Grade 1.4301	Grade 1.4401	Grade 1.4362	Grade 1.4462
0.0	1.000	1.000	1.000	1.000
0.04	0.973	0.974	0.980	0.982
0.08	0.948	0.949	0.961	0.964
0.12	0.923	0.925	0.943	0.947
0.16	0.899	0.901	0.925	0.929
0.2	0.875	0.878	0.906	0.912
0.3	0.818	0.821	0.861	0.869
0.4	0.762	0.766	0.814	0.824
0.5	0.706	0.710	0.765	0.776
0.6	0.650	0.655	0.713	0.726
0.7	0.595	0.600	0.660	0.673
0.8	0.543	0.547	0.606	0.619
0.9	0.493	0.497	0.552	0.565
1.0	0.446	0.450	0.501	0.512
1.1	0.404	0.407	0.452	0.463
1.2	0.365	0.368	0.408	0.417
1.3	0.331	0.333	0.368	0.376
1.4	0.300	0.302	0.333	0.340
1.5	0.273	0.275	0.301	0.307
1.6	0.249	0.250	0.273	0.279
1.7	0.227	0.229	0.249	0.253
1.8	0.208	0.210	0.227	0.231
1.9	0.191	0.193	0.208	0.211
2.0	0.176	0.178	0.191	0.194
2.1	0.163	0.164	0.176	0.179
2.2	0.151	0.152	0.163	0.165
2.3	0.140	0.141	0.151	0.153
2.4	0.131	0.131	0.140	0.142
2.5	0.122	0.123	0.130	0.132
2.6	0.114	0.115	0.121	0.123
2.7	0.107	0.107	0.114	0.115
2.8	0.100	0.101	0.106	0.108
2.9	0.094	0.095	0.100	0.101
3.0	0.089	0.089	0.094	0.095

Note

The buckling curves are derived from the following expressions:

$$c_\epsilon = \frac{1}{j_\epsilon + \sqrt{j_\epsilon^2 - \bar{I}_\epsilon^2}} \quad j_\epsilon = 0.5 \left(1 + 0.65 \bar{I}_\epsilon \sqrt{\frac{235}{\rho_y}} + \bar{I}_\epsilon^2 \right)$$

Where the temperature of the member is non-uniform, the compression resistance may conservatively be estimated by assuming a uniform temperature that is equal to the maximum temperature in the member.

The buckling length L_{Efi} of a column for fire design should generally be determined as for ambient temperature design. However, in a braced frame, L_{Efi} may be determined by considering the column as fixed in direction at continuous or semi-continuous connections to the column lengths in the fire compartments above and below. This assumption can only be made if the fire resistance of the building components that separate these fire compartments is not less than the fire resistance of the column.

In the case of a braced frame in which each storey comprises a separate fire compartment with sufficient fire resistance, the buckling length of a column in an intermediate storey is given by $L_{Efi} = 0.5L$ and in the top storey the buckling length is given by $L_{Efi} = 0.7L$, where L is the system length in the relevant storey, as shown in Figure 6.1.

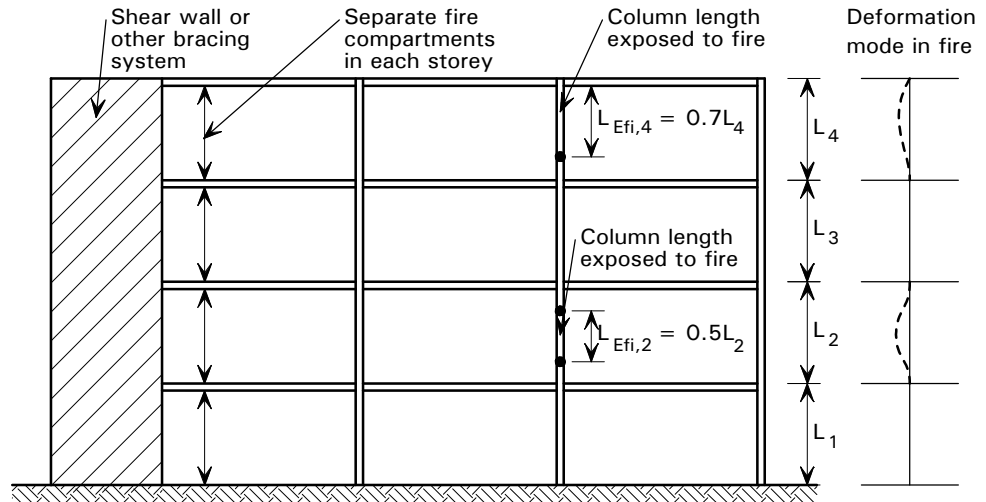

Figure 6.1 Buckling lengths L_{Efi} of columns in braced frames

6.4.4 Laterally restrained beams

The moment capacity $M_{c,\theta}$ of a cross-section at a uniform temperature q may be determined from:

$$M_{c,\theta} = k_{p2,\theta} M_c \quad \text{for class 1, 2 or 3 cross-sections} \quad (6.12)$$

$$M_{c,\theta} = k_{p0.2\text{proof},\theta} M_c \quad \text{for class 4 cross-sections} \quad (6.13)$$

where:

M_c is the plastic moment resistance of the gross cross-section (class 1 or 2 cross-sections), the elastic moment resistance of the gross cross-section (class 3 cross-sections) or the effective moment resistance of the effective cross section (class 4 cross-sections) for design at ambient temperatures in accordance with Section 4.4.2.

$k_{p2,\theta}$ and $k_{p0.2\text{proof},\theta}$ are as defined in Section 6.4.3.

Where it is necessary to allow for the effects of shear, the reduced moment resistance at ambient temperature according to Section 4.4.3 should be used.

The moment capacity $M_{c,\theta,n}$ of a cross-section in a member with a non-uniform temperature distribution may conservatively be determined from:

$$M_{c,\theta,n} = M_{c,\theta} / k_1 k_2 \quad (6.14)$$

where:

$M_{c,\theta}$ is the design moment resistance of the cross-section (or effective cross section for slender cross-sections) at a uniform temperature q equal to the maximum temperature in the cross-section

k_1 is an adaptation factor for non-uniform temperature across the cross-section, which should be taken as 0.7 for a beam exposed to fire

on three sides with a composite or concrete slab on its fourth side, and as 1.0 for a beam exposed to fire on all four sides

k_2 is an adaptation factor for non-uniform temperature along the beam, which should be taken as 0.85 at the supports of a statically indeterminate beam and as 1.0 for all other cases.

The shear capacity $P_{v,\theta}$ of a cross-section with a non-uniform temperature distribution may be determined from:

$$P_{v,\theta} = k_{p2,\theta,web} P_v \quad \text{for class 1, 2 or 3 cross-sections} \quad (6.15)$$

$$P_{v,\theta} = k_{p0.2proof,\theta,web} P_v \quad \text{for class 4 cross-sections} \quad (6.16)$$

where:

P_v is the shear capacity of the gross cross-section at ambient temperature according to Section 4.4.1.

q_{web} is the temperature in the web of the section.

6.4.5 Laterally unrestrained beams

The buckling resistance moment $M_{b,\theta}$ of a laterally unrestrained beam should be determined from:

$$M_{b,\theta} = c_{LT,\theta} k_{p2,\theta} \beta_W S_x p_y \quad \text{for class 1, 2 or 3 cross-sections} \quad (6.17)$$

$$M_{b,\theta} = c_{LT,\theta} k_{p0.2proof,\theta} \beta_W S_x p_y \quad \text{for class 4 cross-sections} \quad (6.18)$$

where:

$c_{LT,\theta}$ is the reduction factor for lateral torsional buckling in fire, determined from Table 6.3

β_W is as defined in Section 4.4.4

$k_{p2,\theta}$ and $k_{p0.2proof,\theta}$ are the retention factors defined in Section 6.4.3 at the maximum temperature q reached anywhere in the section

The non-dimensional slenderness $\bar{I}_{LT,q}$ at temperature q is given by:

$$\bar{I}_{LT,\theta} = \bar{I}_{LT} [k_{p2,\theta} / k_{E,\theta}]^{0.5} \quad \text{for class 1, 2 or 3 cross-sections} \quad (6.19)$$

$$\bar{I}_{LT,\theta} = \bar{I}_{LT} [k_{p0.2proof,\theta} / k_{E,\theta}]^{0.5} \quad \text{for class 4 cross-sections} \quad (6.20)$$

where:

$k_{E,\theta}$ is the retention factor defined in Section 6.4.3 at temperature q .

6.4.6 Members subject to axial compression and bending

The combined effects of compressive loads and bending moments should be checked in accordance with the following expressions to prevent major and minor axis buckling and lateral torsional buckling:

(a) For class 1, 2 or 3 cross-sections:

$$\frac{F_{c,fi}}{c_{\min,\theta} A_g k_{p2,\theta} p_y} + \frac{k_x M_{x,fi}}{k_{p2,\theta} M_{cx,\theta}} + \frac{k_y M_{y,fi}}{k_{p2,\theta} M_{cy,\theta}} \leq 1 \quad (6.21)$$

$$\frac{F_{c,fi}}{c_{\min,\theta} A_g k_{p2,\theta} p_y} + \frac{k_{LT} M_{x,fi}}{c_{LT,\theta} k_{p2,\theta} b_W S_x p_y} + \frac{k_y M_{y,fi}}{k_{p2,\theta} M_{cy,\theta}} \leq 1 \quad (6.22)$$

where:

$F_{c,fi}$, $M_{x,fi}$ and $M_{y,fi}$ are the axial load and bending moments at the fire limit state

$M_{cx,\theta}$ and $M_{cy,\theta}$ are as defined in Section 6.4.4

$k_{p2,\theta}$ is the retention factor at temperature q , as defined in Section 6.4.3

$c_{\min,\theta}$ is the smallest reduction factor for flexural, torsional and torsional-flexural buckling at temperature q , as defined in Section 6.4.3

$c_{LT,\theta}$ is the reduction factor for lateral torsional buckling at temperature q , as defined in Section 6.4.5

$$k_x = 1 - \frac{m_x F_{c,fi}}{c_{x,\theta} A_g k_{p2,\theta} p_y} \leq 3$$

$$\text{with } m_x = (1.2 b_{M,x} - 3) \bar{I}_{x,\theta} + 0.44 b_{M,x} - 0.29 \leq 0.8$$

$$k_y = 1 - \frac{m_y F_{c,fi}}{c_{y,\theta} A_g k_{p2,\theta} p_y} \leq 3$$

$$\text{with } m_y = (2 b_{M,y} - 5) \bar{I}_{y,\theta} + 0.44 b_{M,y} - 0.29 \leq 0.8 \text{ and } \bar{I}_{y,\theta} \leq 1$$

$$k_{LT} = 1 - \frac{m_{LT} F_{c,fi}}{c_{y,\theta} A_g k_{p2,\theta} p_y} \leq 1$$

$$\text{with } m_{LT} = 0.15 \bar{I}_{y,\theta} b_{M,LT} - 0.15 \leq 0.9$$

b_M is an equivalent uniform moment factor, given in Table 6.4

(b) For class 4 cross-sections:

$$\frac{F_{c,fi}}{c_{\min,\theta} A_{eff} k_{p0.2proof,\theta} p_y} + \frac{k_x M_{x,fi} + F_{c,fi} e_x}{k_{p0.2proof,\theta} M_{cx,\theta}} + \frac{k_y M_{y,fi} + F_{c,fi} e_y}{k_{p0.2proof,\theta} M_{cy,\theta}} \leq 1 \quad (6.23)$$

$$\frac{F_{c,fi}}{c_{y,\theta} A_{eff} k_{p0.2proof,\theta} p_y} + \frac{k_{LT} M_{x,fi} + F_{c,fi} e_x}{c_{LT,\theta} k_{p0.2proof,\theta} b_W S_x p_y} + \frac{k_y M_{y,fi} + F_{c,fi} e_y}{k_{p0.2proof,\theta} M_{cy,\theta}} \leq 1 \quad (6.24)$$

where the terms are defined in (a) above except that in the calculation of k_x , k_y , and k_{LT} , A_g should be replaced by A_{eff} and $k_{p2,\theta}$ should be replaced by $k_{p0.2proof,\theta}$, where $k_{p0.2proof,\theta}$ is defined in Section 6.2.

Table 6.4 Equivalent uniform moment factors, b_M

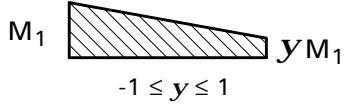
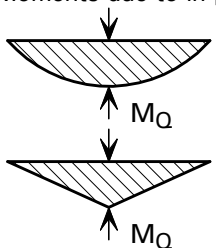
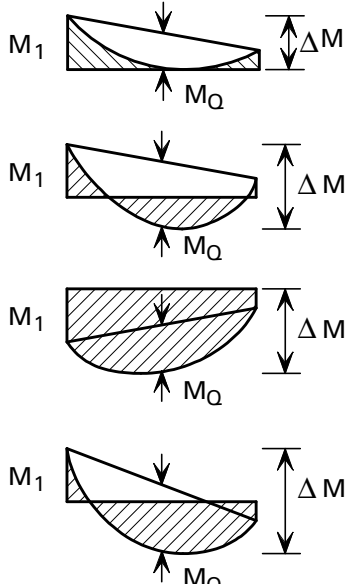
Moment diagram	Equivalent uniform moment factor b_M
<p>End moments</p>  <p>M_1 yM_1 $-1 \leq y \leq 1$</p>	$b_{M,\psi} = 1.8 - 0.7y$
<p>Moments due to in-plane lateral loads</p>  <p>M_Q M_Q</p>	$b_{M,Q} = 1.3$ $b_{M,Q} = 1.4$
<p>Moments due to in-plane lateral loads plus end moments</p>  <p>M_1 M_Q ΔM M_1 M_Q ΔM M_1 M_Q ΔM M_1 M_Q ΔM</p>	$b_M = b_{M,y} + \frac{M_Q}{DM} (b_{M,Q} - b_{M,y})$ <p>$M_Q = \max M$ due to lateral load only</p> <p>For moment diagram without change of sign: $\Delta M = \max M$</p> <p>For moment diagram with change of sign: $\Delta M = \max M + \min M$</p>

6.5 Calculation of temperature rise in stainless steel

The method for calculating the temperature rise in carbon steel can also be applied to stainless steel.

The incremental rise in temperature of a uniformly heated bare stainless steel section in time interval t is given by:

$$Dq_s = \frac{a_c + a_r}{c_s r_s} \frac{H_p}{A_g} (q_f - q_s) Dt \quad (6.25)$$

where:

c_s is the specific heat of stainless steel (J/kg°C), as given in Section 6.3.2

r_s is the density of stainless steel (kg/m³), as given in Table 2.4 (usually considered as temperature independent)

q_f is the temperature (°C) of the fire at a particular time t (secs)

q_s is the temperature of the stainless steel section (°C) which is assumed to be uniform, at time t

H_p/A_g is the section factor (m⁻¹), i.e. the ratio of the heated perimeter H_p to the gross cross-sectional area, A_g

a_c is the coefficient of heat transfer by convection (usually taken as 25W/m² °C)

a_r is the coefficient of heat transfer by radiation, given by:

$$a_r = \frac{5.67e}{q_f - q_s} \left[(q_f + 273)^4 - (q_s + 273)^4 \right] \times 10^{-8} \quad (6.26)$$

The parameter e is the resultant emissivity and represents the radiation transmitted between the fire and the metal surface and its magnitude depends on the degree of direct exposure of the element to the fire. Elements which are partially shielded from the radiant effects of the heat of the fire would have a lower value of e . Conservatively e may be taken as 0.5.

The above equation for the incremental temperature rise may be used to determine steel temperatures by incremental integration, if the variation of the fire temperature with time is known. The standard temperature–time curve for a cellulosic fire is given in DD ENV 1991-2-2^[31]:

$$q_f = 20 + 345 \log_{10}(8t + 1) \quad (6.27)$$

where:

t is the elapsed time (minutes).

7 FABRICATION ASPECTS

7.1 General

Stainless steel is not a difficult material to fabricate; it can be readily cut, formed and welded. Many fabrication and joining processes are similar to those used for carbon steel, but the different characteristics of stainless steel require special attention.

An overriding objective is to maintain the steel's corrosion resistance. It is essential to ensure at all stages of storing, handling, forming and welding that mechanical or other damage to the surface (i.e. the oxide layer) is minimized and the good surface appearance is preserved. This is particularly important because stainless steel is usually specified for its corrosion resistance, aesthetic appeal or both. Care is required in storing and handling stainless steel where the material has been selected for its surface finish (especially bright annealed or polished finishes).

It is important to avoid contamination of the surface of stainless steel components by carbon steel and iron at all stages of fabrication, handling, storage, transportation and erection. This is to prevent carbon steel pick-up, which may subsequently rust and stain the surface. Measures should be taken by the fabricator to prevent such contamination; these may include the use of quarantined work areas, the use of tools which are dedicated only to stainless steel, the use of stainless steel wire brushes or wool, avoiding the use of carbon steel lifting tackle and protecting the forks of fork lift trucks.

Contact with organic contaminants such as oils, greases, dyes, glues, adhesive tape and other similar deposits should be avoided. When they are used, their suitability should be checked with their manufacturer.

Achieving specified dimensions in stainless steel structures can be more difficult than in carbon steel structures because of stainless steel's tendency to spring back after bending (Section 7.3.2) and its higher coefficient of thermal expansion and lower thermal conductivity (see also Section 7.4.2 for specific guidance on controlling distortion arising from welding). Consequently, higher tolerances may have to be accepted than those for carbon steel. In detailing joints, consideration should be given to these higher tolerances and to clearances for bolts near corners.

In the absence of a national specification, fabrication and erection of stainless steel structures should be carried out in accordance with the European specification DD ENV 1090 *Execution of steel, Part 6 Supplementary rules for stainless steels*^[32].

7.2 Storage and handling

Generally, greater care is required in storing and handling stainless steel than carbon steel, to avoid damaging the surface finish (especially for bright annealed or polished finishes) and to avoid contamination by carbon steel and iron. Storage and handling procedures should be agreed between the relevant parties to the contract in advance of any fabrication and in sufficient detail to

accommodate any special requirements. The procedures should cover, for instance, the following items:

- The steel should be inspected immediately after delivery for any surface damage.
- The steel may have a protective plastic or other coating. This should be left on as long as possible, removing it just before final fabrication. The protective covering should be called for in the procurement document if it is required (e.g. for bright annealed finishes).
- Storage in salt-laden humid atmospheres should be avoided. Storage racks should not have carbon steel rubbing surfaces and should, therefore, be protected by wooden, rubber or plastic battens or sheaths. Sheets and plates should preferably be stacked vertically; horizontally stacked sheets may get walked upon, with a risk of iron contamination and surface damage.
- Carbon steel lifting tackle, e.g. chains, hooks, and cleats, should be avoided. The use of isolating materials, or the use of suction cups, will prevent iron pick-up. The forks of fork lift trucks should also be so protected.
- Contact with chemicals, including undue amounts of oils and greases (which may stain some finishes), should be avoided.
- Ideally, segregated fabrication areas for carbon steel and stainless steel should be used. Only tools dedicated to stainless steel should be employed (this particularly applies to grinding wheels and wire brushes). Note that wire brushes and wire wool should be of stainless steel and generally in a grade that is equivalent in terms of corrosion resistance (e.g. do not use ferritic stainless steel brushes on austenitic stainless steel).
- As a precaution during fabrication and erection, it is advisable to ensure that any sharp burrs formed during shearing operations are removed.
- Consideration should be given to any requirements needed in protecting the finished fabrication during transportation.

7.3 Shaping operations

7.3.1 Cutting

Stainless steel may be cut using standard mechanical cutting methods, including shearing and sawing. Cutting machine power requirements will be greater than those used for similar thicknesses of carbon steel, due to the work hardening of the steel. If possible, cutting (and machining in general), should be carried out when the metal is in the annealed (softened) state to limit tool wear.

For cutting straight lines, guillotine shearing is widely used. By using open ended guillotines, a continuous cut greater in length than the shear blades can be achieved, although at the risk of introducing small steps in the cut edge.

Thermal cutting techniques, such as plasma arc, are also used, particularly for cutting thick plates and profiles and where the cut edges are to be machined, e.g. for weld preparation. Where the thickness of material allows, laser cutting is a useful technique. Specialist water-jet cutting can also be used on stainless

steel. These low or zero heat input cutting methods are useful in reducing or eliminating the risk of distortion during cutting complex shapes.

Oxyacetylene cutting is not satisfactory for cutting stainless steel unless a powder fluxing technique is used.

7.3.2 Cold forming

Stainless steel is readily shaped by commonly used cold forming techniques such as roll-bending, spinning, pressing and deep drawing. For structural applications, press brake bending is the most relevant technique, though roll forming may be more economic for high volume thin gauge products. The power requirement for bending stainless steel will be higher than for bending carbon steel, due to work hardening. Furthermore, stainless steel has to be overbent (to counteract the effects of springback) to a slightly higher degree than carbon steel.

Stainless steel's high ductility allows small radii to be formed. It is generally recommended that the minimum inside bend radii should be $2.0t$ for austenitic grades and $2.5t$ for duplex grades, where t is the thickness of the material. However, smaller radii are achievable, depending on the forming technique and configuration of the forming equipment.

When bending hollow sections the following guidance may be given:

- the outer tube diameter to wall thickness ratio should not exceed 15 (to avoid costly tooling).
- the bend radius (to centreline of tube) should not be less than $2.5D$, where D is the outer diameter
- any welding bead should be positioned close to the neutral axis, to reduce the bending stresses at the weld.

7.3.3 Holes

Holes may be drilled or punched. In drilling, positive cutting must be maintained to avoid work hardening and this requires sharp bits with correct angles of rake and correct cutting speeds. The use of a round tipped centre punch is not recommended, as this work hardens the surface. Either a centre drill should be used or, if a centre punch has to be used, it should be of the triangular pointed type. Punched holes can be made in austenitic stainless steel up to about 20 mm in thickness. The minimum diameter of hole that can be punched is 2 mm greater than the sheet thickness. Punched holes should be avoided in corrosive environments because of crevicing that may possibly lead to local corrosion.

Hardened washers may be necessary under bolt heads to prevent any tendency to dig into the surface because of the soft surface on some grades of stainless steel.

7.4 Welding

7.4.1 Specifications and processes

The welding of all the grades covered by this design guide is widely and successfully carried out using normal processes. General cleanliness and the absence of contamination are important for attaining good weld quality. Weld

contamination from zinc, including that arising from galvanised products, and from copper and its alloys should be avoided. The “as welded” profile of stainless steel is usually more important than with carbon steel and should be specified.

It is essential that welds are made using correct procedures to ensure the strength of the weld, achieve a defined weld profile and maintain corrosion resistance of the weld and surrounding material. The relevant specification for welding stainless steels is BS EN 1011 *Requirements for fusion welding of metallic materials*, Part 3: *Stainless steels*^[33]. Welding should be carried out to an approved welding procedure according to a standard such as BS EN 288-2^[34]. Welders should be approved in accordance with BS EN 287-1^[35].

Manual metal arc (MMA), metal inert gas (MIG), tungsten inert gas (TIG) and resistance welding are all suitable methods for welding stainless steel. The shielding gas used in MIG and TIG processes should not contain carbon dioxide, to avoid the possibility of decomposition leading to carbon pick-up. Pre-heat is not necessary or desirable when welding austenitic, ferritic and duplex stainless steels. In the case of duplex grades, nitrogen shielding gas should be avoided. It is possible to weld stainless steel to other materials, including carbon steel, provided that the appropriate filler is used. The accepted procedure is to use an over-alloyed austenitic electrode to ensure adequate mechanical properties and corrosion resistance. (Generally a filler of grade 23 12 L (309) to BS EN 12072^[36] is suitable for welding grade 1.4301 (304) to carbon steel.)

Compatible consumables should be used, such that the weld yield and ultimate strengths exceed those of the parent material and the risk of solidification cracking is minimised. The weld should be at least as corrosion resistant as the parent material. All welding consumables should conform with the requirements specified in DD ENV 1090-6^[32].

Welding deficiencies such as undercut, lack of penetration, weld spatter, slag and stray arc strikes are all potential sites for crevice corrosion and must be avoided. Stray arc strikes or arcing at loose earth connections can also damage the passive layer and possibly give rise to corrosion; they must be avoided also. Surface weld inspection for stainless steel is usually carried out using dye penetration inspection (DPI).

7.4.2 Welding distortion

The distortion of stainless steel, particularly of austenitic grades, can be a problem because of their higher coefficients of thermal expansion and lower thermal conductivities. The following guidelines will help control welding distortions:

- Minimise the extent of welding.
- Minimise the amount of deposited weld metal (e.g. use double V preparations in preference to single V).
- Use symmetrical joints.
- Design to accommodate dimensional tolerances.
- Use efficient clamping jigs.
- Use closely spaced tack welds laid in a balanced sequence.

- Ensure that good fit up and alignment is obtained prior to welding.
- Use the lowest heat input commensurate with the selected weld process.
- Use balanced welding and appropriate sequences.

7.5 Finishing

The surface finish of stainless steel is often an important design consideration and should be clearly specified according to architectural or functional requirements. As a general rule, for a given grade in a given environment, the finer the finish, the greater the cost and the better the corrosion resistance. This is where precautions taken earlier in handling and welding will pay off. Initial planning is important in reducing costs. For instance, if the tube to tube weld in a handrail or balustrade is hidden inside an upright, there will be a reduced finishing cost and a significant improvement in the final appearance of the handrail.

After fabrication, the surface of the steel must be restored to its optimum corrosion resisting condition. Spray or immersion pickling after fabrication will remove weld scale, heat tint and surface iron contamination. Scale and heat tint can be removed from welds with pickling paste by brush or using electrochemical weld cleaning equipment. Loosened scale can be removed by brush, but water jet is preferable as there is less risk of the spread of contamination.

Abrasive treatments, such as grinding, polishing and buffing, produce unidirectional finishes and thus the blending of welds may not be easy on plates/sheets. A degree of experimentation may be required to determine detailed procedures to obtain a suitable finish. Electrolytic polishing removes a thin surface layer; a range of finishes from dull to a bright lustre can be produced, depending largely on the initial surface of the material. There are other finishing processes but these would only rarely be used for structural stainless steel. See Reference 5 for more information.

It is worth noting again that the surface should be free of contaminants in the assembled structure. Particular consideration should be given to the possibility of contamination arising from work on adjacent carbon steelwork, especially from grinding dust. Either the stainless steel should be protected by removable plastic film, or final cleaning after completion of the structure should be specified in the contract documents.

7.6 Galling and seizure

Bolting materials in the softened condition are prone to seizure or galling, which occurs when the protective films on two surfaces are in rubbing contact and the underlying surfaces weld together. This results in the inability to remove nuts from bolts and invariably leads to considerable time wastage in maintenance work when chiselling and flame cutting is necessary to remove bolts.

However, galling is a problem in limited circumstances only; it is only likely if the initial assembly contains partly damaged threads, in fine threads or tight fitting thread forms. Because of the absence of corrosion products, stainless steel nuts and bolts are more prone to working loose under vibrating loads, rather than to seizing.

Stainless steel self-tapping screws used in a stainless steel base material can be prone to seizure, particularly where the screws and base material are different grades (see Section 2.3.2, *Fasteners*).

The following methods may be used to avoid galling problems:

- Dissimilar standard grades of stainless steel may be used - which vary in composition, work hardening rate and hardness (e.g. Grade A2-C2, A4-C4 or A2-A4 bolt-nut combinations from BS EN ISO 3506),
- In severe cases, a proprietary high work-hardening stainless steel alloy may be used for one component or hard surface coatings can be applied,
- Anti-galling agents such as PTFE dry film spray.

8 INTRODUCTION TO DESIGN TABLES

8.1 General

8.1.1 Scope

This publication includes design tables for gross section properties, section classification and effective section properties and member capacities for a wide range of cold formed stainless steel sections. The grades of stainless steel covered are austenitic stainless steel grades 1.4301 (304), 1.4401/1.4404 (316/316L), and duplex grades 1.4362 (SAF 2304) and 1.4462 (2205).

The design tables cover seven structural forms of cold formed stainless steel sections that are used in construction:

- Circular hollow sections (CHS).
- Rectangular hollow sections (RHS).
- Square hollow sections (SHS).
- Channels.
- Double channels back to back
- Equal angles.
- Double equal angles back to back.

8.1.2 Double sections

For double sections, the section properties have been calculated on the basis that the sections are back to back with no gap between them. For double sections with a spacing between the two components, the properties given are thus conservative, except for the buckling parameter, see Section 8.2.6.

8.1.3 Internal corner radius

In the design tables, it is assumed that the internal corner radius, r_i , is twice the section thickness, t , for all sections. This provides conservative design information for sections with smaller internal corner radii, but see also Section 7.3.2.

For rectangular hollow sections and channels:

$$d = D - 2(r_i + t) \text{ and with } r_i = 2t, \text{ this gives } d = D - 6t$$

For rectangular hollow sections:

$$b = B - 2(r_i + t) \text{ and with } r_i = 2t, \text{ this gives } b = B - 6t$$

For sections with larger internal radii, see Appendix C.

All the section properties have been calculated allowing for rounded corners, except torsion and warping constants, where approximate formulae are used instead.

8.1.4 Organisation of design tables

For each structural form, three sets of design tables are given wherever appropriate:

Section A - Dimensions and Gross Section Property Tables

These tables give the dimensions and the section properties of the gross sections. The gross section properties are applicable to cold formed sections of any grade of steel. The gross section properties have been calculated from the nominal geometry of the cross-sections.

Section B - Section Classification and Effective Section Property Tables

These classify the sections according to Table 3.1 under different loading conditions and give design data on the effective cross-sections for slender sections. The effective section properties are related to the design strength of the materials and thus four sets of properties are given for the different stainless steel grades, i.e. grades 1.4301 (304), 1.4401/1.4404 (316/316L), 1.4362 (SAF 2304) and 1.4462 (2205). There are four classes of sections, namely: class 1 plastic, class 2 compact, class 3 semi-compact and class 4 slender. The section classification depends on the width-to-thickness ratios of the elements of the cross-sections. The effective section properties have been calculated from the effective cross-sections of the structural form for slender sections. Properties are presented for cross-sections under compression, and for bending about the x and y axes.

Sections C, D, E, F - Member Capacity Tables

These give the capacities and resistances of cold formed stainless steel sections as three typical structural members:

- members in compression, or struts
- members in tension, or ties
- members in bending, or beams.

The capacities are determined in accordance with the design recommendations given in Section 4.

For each structural form, the compression resistance tables present data for a wide range of member effective lengths, from 1 m to 14 m for hollow sections and from 1 m to 10 m for channels and angles (it is advisable for designers to check the availability of members longer than 10 m). The moment capacity tables give buckling resistance moments for single and double channels from 1 m to 10 m in length. Linear interpolation between the tabulated values is permitted. The calculated values in the tables have been rounded to three significant figures. A summary of the member capacity tables is given in Table 8.1.

Note that it is not necessary to give any table for members subject to combined loading because the main parameters required in these checks may be found in the strut and the beam tables. Furthermore, an interaction formula using m_x , m_y , and m_{LT} permits a less conservative approach than design with tabulated data would allow.

No web bearing and buckling resistances are given.

Table 8.1 Summary of member capacity tables

Type	Structural form of cold formed stainless steel section						
	Hollow sections			Channels		Equal angles	
	Circular	Rectangular	Square	Single	Double	Single	Double
Struts	✓	✓	✓	✓	✓	✓	✓
Ties	-	-	-	-	-	✓	✓
Beams	✓	✓	✓	✓	✓	-	-

8.1.5 Ranges of section sizes

At present, there is no specification on section sizes of cold formed stainless steel sections for structural applications. Consequently, a wide variety of sizes and shapes is used in practice. In order to provide practical design information, a large number of stockholders, fabricators and manufacturers in the U.K. and Europe were contacted during the preparation of this publication in order to establish the most commonly used sizes for various section shapes.

Based on the collected information, ranges of section sizes for the cold formed stainless steel sections presented in this publication were established according to the following considerations:

- limitations in the process of cold forming
- practical sizes in typical use
- structural economy and effective use of material.

8.1.6 Axis convention

The convention adopted throughout this publication is shown in Figure 8.1.

$x-x$ axis	major principal axis for single and double channels, rectangular and square hollow sections, rectangular axis for single angles but axis of symmetry for double angles
$y-y$ axis	minor principal axis for single and double channels, rectangular and square hollow sections, rectangular axis for single angles axis normal to the axis of symmetry for double angles
$u-u$ axis	major principal axis for single angles
$v-v$ axis	minor principal axis for single angles
$z-z$ axis	longitudinal axis along member length.

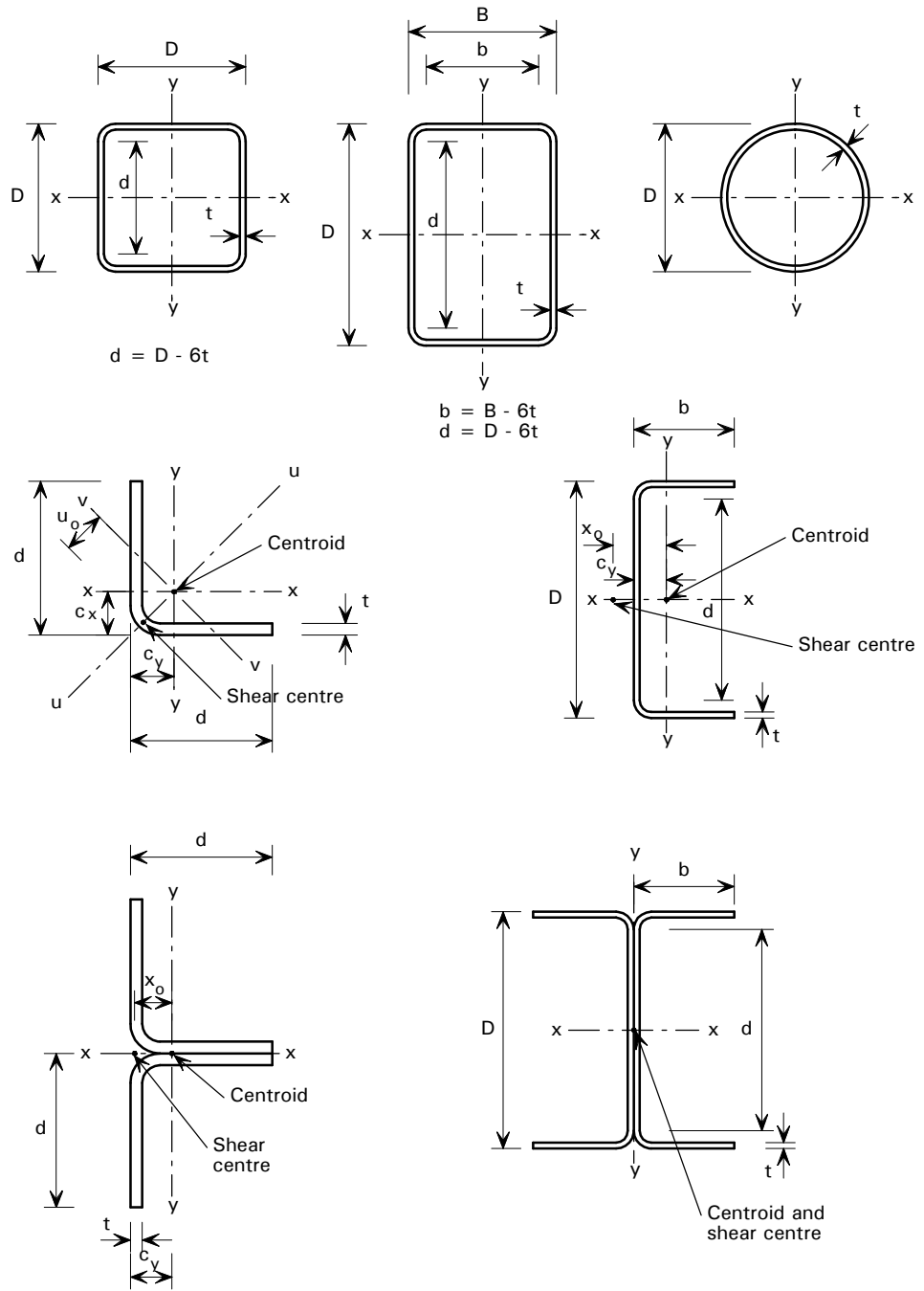

Figure 8.1 Axis convention and dimensions of sections

8.1.7 Material

Table 8.2 gives the material properties used in the design tables.

Table 8.2 *Material properties used in design tables*

Grade	P_y (N/mm ²)	Other properties
1.4301 (304)	210	
1.4401/1.4404 (316/316L)	220	$E = 200,000$ N/mm ²
1.4362 (SAF 2304)	400	$G = 76,900$ N/mm ²
1.4462 (2205)	460	Density = 7900 kg/m ³

8.1.8 Section sizes

For each section shape, a range of section sizes together with up to five section thicknesses is given. External dimensions of the sections are used in the section designation.

8.1.9 Units

The dimensions of sections are given in millimetres (mm).

The centimetre unit (cm) is used for the calculated properties, except for e_x and e_y in Design Tables 11, 13 and 14, which are given in millimetres.

The mass and force units used are the kilogramme (kg), the newton (N) and the metre per second per second (m/s²) so that $1 \text{ N} = 1 \text{ kg} \times 1 \text{ m/s}^2$. For convenience a standard value of the acceleration due to gravity has been generally accepted as 9.81 m/s². Thus the force exerted by 1 kg under the action of gravity is 9.81 N and the force exerted by 1 tonne (1000 kg) is 9.80665 kilonewtons (kN).

8.2 Gross section properties

8.2.1 Unit mass

A density of 7900 kg/m³ was used to calculate the unit mass of the sections. In all cases, including double sections, the tabulated masses are for the steel sections alone and no allowance has been made for connecting materials or fittings.

8.2.2 Area, second moment of area and radius of gyration

The area, A_g , and the second moment of area (or 'moment of inertia'), I , of the gross cross-section have been calculated taking account of the rounded corners of the sections. A useful design parameter for buckling calculations is the radius of gyration, which is evaluated as follows:

$$r = \sqrt{\frac{I}{A_g}}$$

$$\text{For a CHS, } I = \frac{p}{64} (D^4 - [D - 2t]^4) \quad \text{and} \quad r = 0.25 \sqrt{D^2 + [D - 2t]^2}$$

8.2.3 Elastic and plastic section modulus

The elastic section modulus of a section is used to calculate its elastic moment capacity, based on its design strength. The elastic section modulus, Z , is evaluated as follows:

$$Z = \frac{I}{y}$$

where:

y is the distance from the elastic neutral axis to the extreme fibre of the section.

The elastic section modulus can be used to determine the stress at the extreme fibre of the section. For channels under bending about the y -axis, only the minimum section modulus, which relates to the toe of the cross-section, is given.

The plastic section modulus, S , is the sum of the first moments of area of all the elements in the cross-section about the equal area axis of the cross-section.

The plastic section modulus for CHS is given by:

$$S = 0.167(D^3 - [D - 2t]^3)$$

8.2.4 Torsion constants

For rectangular and square hollow sections, the torsion constants, J and C are evaluated as follows:

$$J = \frac{ht^3}{3} + 2KA_h$$

$$C = \frac{J}{t + \frac{K}{t}}$$

where:

$$A_h = (B - t)(D - t) - r_m^2(4 - \pi)$$

$$h = 2(B - t + D - t) - 2r_m(4 - \pi)$$

$$K = \frac{2A_h t}{h}$$

$$r_m \text{ is the average corner radius} = 0.5(r_e + r_i).$$

For single angles and single channels, the torsion constant, J , is evaluated conservatively as follows:

$$J = \frac{A_g t^2}{3}$$

For double channels and double angles, the individual sections are conservatively assumed to act separately from one another under torsion. Thus

the torsional constants of the double sections are taken as double that of the individual sections.

8.2.5 Warping constant

No warping constant is given for hollow sections, as it is not required for design (see Section 4.3.3).

For channels and equal angles, the distance of the shear centre from the centroid of the cross-section, x_o , is illustrated in Figure 8.1. In both double channels and double angles, the individual sections are conservatively assumed to act separately from one another under warping. The warping constant, H , is evaluated as follows:

a) Single channels

$$H = [1 - 4d] \frac{D_m^2 b_m^3 t}{12} \left[\frac{2D_m + 3b_m}{D_m + 6b_m} \right]$$

where:

$$D_m = D - t$$

$$b_m = b - 0.5 t$$

δ is the correction factor due to rounded corners (given in 3.5).

b) Double channels back to back

$$H = [1 - 4d] \frac{D_m^2 b_m^3 t}{3}$$

This expression is based on the warping constant of an equivalent I-shape section and modified for the presence of rounded corners. D_m , b_m and δ are defined above.

c) Single equal angles

$$H = (1 - 4d) \frac{t^3 \left(d - \frac{t}{2} \right)^3}{18}$$

d is defined above.

d) Double equal angles

The warping constant for double equal angles is double that of a single equal angle of the same size.

8.2.6 Buckling parameter and torsional index

The lateral torsional buckling check for unrestrained beams involves the buckling parameter, u , and the torsional index, x . For single channels and double channels, they are evaluated as follows:

$$u = \left[\frac{I_y S_x^2 g}{A_g^2 H} \right]^{0.25} \quad x = 1.132 \sqrt{\frac{A_g H}{I_y J}}$$

$$\text{where } g = 1 - \frac{I_y}{I_x}$$

The section properties of double channels have been calculated on the basis that the sections are back to back with no gap between them. When calculating the lateral torsional buckling resistance of double channels with a gap between the components, the buckling parameter, u , should be set to 1.0.

8.3 Effective section properties

In general, slender elements of the cross-section of cold formed sections will buckle under compression, while corners remain fully effective. An element is slender if its width-to-thickness ratio exceeds the semi-compact limits given in Table 3.1. Based on the effective width concept, effective cross-sections may be established according to Table 3.2 for cross-sections under different loading conditions. Since the effective section properties are related to the design strength of the material, so the tables give effective section properties for each of the four design strengths covered (210, 220, 400, and 460 N/mm²).

Circular hollow sections with a class 4 cross-section have been excluded from the member capacity tables since no rules are given for calculating the effective area of class 4 circular hollow sections.

8.3.1 Section classification

The section classification of a cross-section depends on the highest (least favourable) class of its constituent elements that are partially or wholly in compression. For each section, section classifications are given in the design tables for cross-sections under axial compression and bending about the x and y axes.

It has been conservatively assumed that the class of a double section follows that of the single section, except for the flanges of double channels, which have been classified according to the rules for welded elements.

8.3.2 Resistance factor under compression

The resistance factor under compression, b_c , given in the design tables is required in the calculation of the compression capacity of a cross-section. It is defined in Section 4.3.3.

8.3.3 Shift in neutral axes

In the cross-section of single channels, single angles and double angles, there is only one axis of symmetry and the neutral axis of the effective cross-section

under compression does not coincide with that of the gross cross-section if the section is slender. This shift of the neutral axis is denoted as e_x and e_y and the sense is indicated in Figure 8.2.

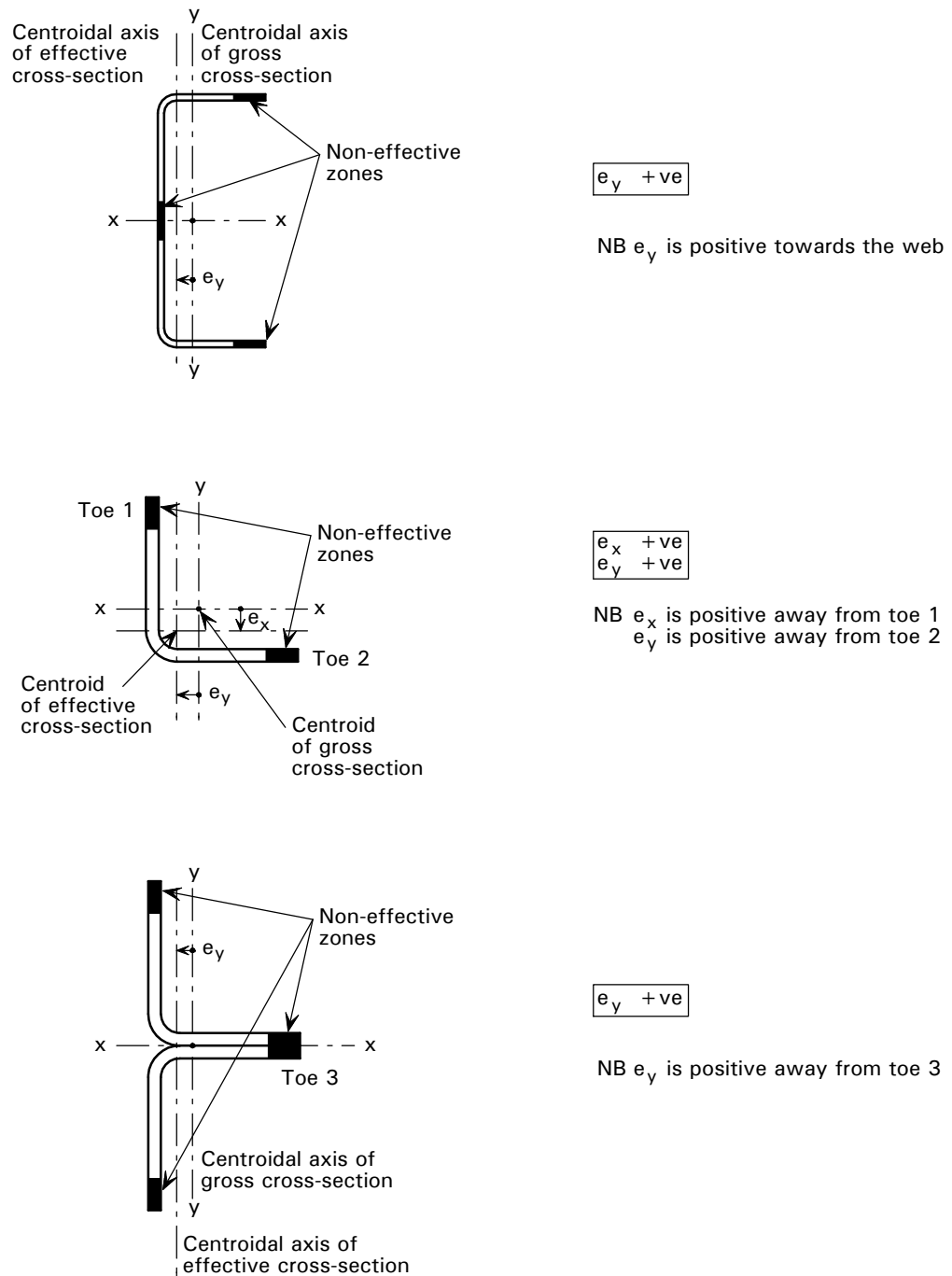

Figure 8.2 Shift in neutral axes of slender sections under compression

For slender sections, the shift of neutral axis, e , is required in the calculation of the resistance of a member in compression because of the additional bending moment induced in the cross-section due to the ' $P-d$ ' effect. Reference should be made to Section 8.4.2 for the evaluation of compression resistances of members with slender sections in compression.

8.3.4 Effective second moment of area and effective section modulus

Both the effective second moment of area, I_{eff} , and the effective section modulus, Z_{eff} , are given in the design tables, as they are required for the calculation of deflection and moment capacity respectively.

8.3.5 Resistance factor under bending

The resistance factor under bending, β_w , given in the design tables is required in the calculation of the buckling resistance moment and is defined in Section 4.4.4.

8.4 Members in compression

Sections which are classified as slender under axial compression are marked using the symbol ‘*’ adjacent to the thickness in the design tables.

8.4.1 Compression resistance

The compression resistance of a member, P_c , is given by expression (4.8). Values of P_c over a range of effective length are given in the design tables. Table 8.3 gives the relevant elastic buckling loads and corresponding effective lengths for flexural buckling and torsional-flexural buckling for the various section shapes.

For double channels and double angles, the buckling curve for welded open sections was used to calculate the reduction factor for buckling, χ .

The value of the effective length L_{Ez} for torsional-flexural buckling depends on the degree of torsional and warping restraint. For struts with concentric connections, L_{Ez} can conservatively be taken as the larger of L_x and L_y . Guidance on the calculation of L_{Ez} for struts with eccentric connections is given in Section 8.4.2.

Table 8.3 Critical elastic buckling loads with corresponding effective lengths in the design tables

	Flexural buckling				Torsional-flexural buckling	
	Major axis		Minor axis		Elastic buckling load, P_E	Effective length L_E
	Elastic buckling load P_E	Effective length L_E	Elastic buckling load, P_E	Effective length L_E		
Circular/square hollow sections	P_x	L_{Ex}	P_y	L_{Ey}	-	-
Double channels back to back	P_x	L_{Ex}	P_y	L_{Ey}	P_z	$L_{Ez}^{3)}$
Rectangular hollow sections	P_x	L_{Ex}	P_y	L_{Ey}		
Single channels/double angles back to back	P_x	L_{Ex}	P_y	L_{Ey}	P_{xz}	$L_{Ez}^{3)}$
Single equal angles ¹⁾	$P_x = P_y^{2)}$	$L_{Ex} = L_{Ey}$	P_v	L_{Ev}	P_{uz}	$L_{Ez}^{4)}$

Notes

- 1) For single angles, $L_x = L_y = L_u = L_v$
- 2) The x and y axes of single equal angles are not the principal axes but the rectangular axes.
- 3) $L_{Ez} = \max(L_x, L_y)$
- 4) $L_{Ez} = \max(L_x, L_v)$

8.4.2 Compression members with eccentric connections (single channels, single angles and double angles back to back)

When loaded axially, these sections are subject to an additional moment due to the eccentricity of the point of load application from the centroid of the cross-section. Table 25 of BS 5950-1^[10] gives slenderness ratios for single channels, single angles and double angles back to back of carbon steel sections for various end conditions. These were based on test results and take into account both the effects of end fixity and end moments due to eccentricity of connection on the buckling resistance.

However, no equivalent tests have been carried out on stainless steel sections, which means it is not possible to give any comparable guidance. Until such guidance has been developed, the following approach may be adopted.

- The design rules for carbon steel given in Table 25 of BS 5950-1 may be used to calculate an effective slenderness λ about each axis that takes into account the effects of end fixity and eccentric connection.
- For each axis, an effective length, L_E to be used in the tables in this publication can be calculated from $L_E = \lambda r$, where r is the appropriate radius of gyration.

Note that the rules in BS 5950-1 apply only to flexural buckling. For torsional-flexural buckling, a conservative approach for making adequate allowance for the effect of eccentric connection is to calculate L_{Ez} from the following:

For single channels:

$$L_{Ez} = \max[L_x, L_y, 0.7L_y + 30r_y]$$

For single angles:

$$L_{Ez} = \max [L_x, 0.7L_x + 30r_x, 0.7L_y + 15r_y]$$

For double angles:

$$L_{Ez} = \max \left[L_y, 0.7L_y + 30r_{ym}, \left(L_x^2 + (I_c r_{xm})^2 \right)^{0.5}, 1.4I_c r_{xm} \right]$$

where:

r_{xm} and r_{ym} are the radii of gyration of the double angle back to back about the x and y axes

$$I_c = \frac{L_c}{r_y} \leq 50$$

in which L_c is measured between interconnecting bolts for back to back struts, or between end welds or end bolts of adjacent battens for battened angle struts.

It should be noted that for monosymmetric sections such as double angles, the x axis is the axis of symmetry, which is *not* the convention adopted in Table 25 of BS 5950-1.

This approach can be used for sections connected by one, two or more fasteners at each end. In accordance with Table 25 of BS 5950-1, for single or double angles connected by *one* bolt only, the compression resistance should be reduced to 80% of the values given in the design tables.

If the section is slender, it must also be checked for the combined effects of the axial load and moment caused by the shift in neutral axis and so the following condition must be satisfied:

$$\frac{F}{P_c} + \frac{Fe_x}{M_{cx}} + \frac{Fe_y}{M_{cy}} \leq 1$$

where:

F is the design axial compressive force

P_c is the smallest of P_{cx} , P_{cy} , P_{cz} and P_{czt} (see Section 4.3.3)

M_c is the moment capacity = $p_y Z_{eff}$

e_x , e_y is the shift of x or y neutral axis for slender sections under compression (the values are given in the Effective Section Property Tables).

8.4.3 Interconnections for double sections

For double channel and double angle sections, the compression resistances have been calculated on the assumption that the double section acts as a single integral member, i.e. the slenderness is based on the radius of gyration for the double section. To achieve this, the members must be continuously connected.

If the sections are not continuously connected, then the compression resistance about the axis parallel to the connected surfaces should be based on a higher slenderness. In the absence of rules for stainless steel, the guidance for carbon steel in clauses 4.7.9 to 4.7.13 of BS 5950-1^[10] can be used, where the

slenderness of the double section, λ_b is given by:

$$I_b = \left[I_m^2 + I_c^2 \right]^{0.5} \geq 1.4 I_c$$

where:

I_m is the slenderness of the double member about the axis parallel to the connected surfaces

I_c is the slenderness of a single angle or channel (based on its minimum radius of gyration) between interconnections and $I_c \leq 50$

An effective length L_E to be used in the tables in this publication can be calculated from this modified slenderness by setting $L_E = \lambda_b r$.

The guidance in clause 4.7.13 of BS 5950-1 regarding the strength and maximum pitch of interconnections is applicable.

For double angles with eccentric connections, the effect of the distance between interconnection on the slenderness is taken into account in the method described in Section 8.4.2. for making allowance for the additional moment due to the eccentricity of the point of load application.

8.5 Members in tension

Tables are given for single and double angles in tension.

For single angles connected through one leg only or double angles connected to the same side of a gusset or member, the equivalent tension area is given by:

For bolted connections: Equivalent tension area = $(A_e - 0.5a_2)$

For welded connections: Equivalent tension area = $(A_g - 0.3a_2)$

For double angles connected through one leg only when the gusset is between the angles, the equivalent tension area is given by:

For bolted connections: Equivalent tension area = $(A_e - 0.25a_2)$

For welded connections: Equivalent tension area = $(A_g - 0.15a_2)$

where the terms are defined in Section 4.2.

The effective net area of a bolted equal angle section A_e is given by:

$$A_e = a_{e1} + a_{e2} \quad \text{but} \leq 1.2 (a_{n1} + a_{n2})$$

where:

$$a_{e1} = K_e a_{n1} \quad \text{but} \leq a_1$$

$$a_{e2} = K_e a_{n2} \quad \text{but} \leq a_2$$

$$a_{n1} = a_1 - \text{area of bolt holes in connected leg}$$

$$a_{n2} = a_2$$

K_e is as defined in Section 3.4

$$a_1 = \text{gross area of connected leg} = dt$$

$$a_2 = A_g - a_1.$$

8.6 Members in bending

8.6.1 Moment capacity

The moment capacities M_c of the sections for bending about the x and y axes are given by expressions (4.19), (4.20) and (4.21).

Values governed by $M_c = 1.2 p_y Z$ are printed in italic type because higher values may be used in some circumstances (see Section 4.4.2).

For single channels subject to bending about the y -axis, the following conservative assumptions were made:

- section classification and effective section properties for slender class 4 cross-sections were based on the channel toes being in compression and the web in tension.
- moment capacities were calculated using the minimum elastic section modulus; this corresponds to maximum stress at the toes of the channel.

Where the shear load is high, the values given in the design tables should be reduced in accordance with the design rules given in Section 4.4.3. The effects of shear lag may also have to be considered, depending on the ratio of the flange width to member length, see Section 3.6. Flange curling need not be considered for the sections in the tables.

8.6.2 Shear capacity

The shear capacity of the cross-section, P_v , given in the design tables is evaluated according to:

- for circular hollow sections:

$$P_v = 0.36 p_y A_g$$

- for channels with the load acting parallel to the y -axis (i.e. the web):

$$P_v = 0.6 p_y t D \quad \text{for single channels}$$

$$P_v = 1.2 p_y t D \quad \text{for double channels}$$

- for hollow sections with the load acting parallel to the y -axis (i.e. the longer sides):

$$P_v = 0.6 p_y \left[\frac{D}{D+B} \right] A_g$$

- for hollow sections with the load acting parallel to the x -axis (i.e. shorter sides):

$$P_v = 0.6 p_y \left[\frac{B}{D+B} \right] A_g$$

For channels and rectangular hollow sections, only the values of P_v corresponding to the loads acting parallel to the y -axis are given in the design tables.

8.6.3 Buckling resistance moment

Rectangular hollow sections bending about the x -axis, with high D/B ratios, may be susceptible to lateral torsional buckling. However, this mode of failure is only critical for sections with long unrestrained spans; such spans are often outside the practical range of application. The design tables for rectangular hollow sections, therefore, only give a limiting length below which lateral torsional buckling need not be checked. For circular and square hollow sections, lateral torsional buckling does not happen and thus no check is required.

The limiting length L_c has been calculated according to clause B.2.6.1 in Appendix B of BS 5950-1. The maximum value for the slenderness parameter, $\bar{\lambda}_{LT}$, at which lateral torsional buckling can be discounted is taken to be 0.4. The expression for L_c is given as follows:

$$L_c = \left(\frac{0.4}{2.25} \right)^2 \frac{p^2 r_y E}{p_y b_w} \frac{1}{\left[\frac{b_w^2 S_x^2}{A_g J} \left(1 - \frac{I_y}{I_x} \right) \left(1 - \frac{J}{2(1+\nu)I_x} \right) \right]^{0.5}}$$

where b_w is defined in Section 4.4.4.

For laterally unrestrained single and double channels bending about the x -axis, it is necessary to check for lateral torsional buckling. The buckling resistance moment, M_b , is evaluated using expression (4.27).

For a range of effective lengths L_E , values of M_b are given in the design tables.

8.6.4 Interconnections for double channels

As for struts, the buckling resistance moment of double channels has been calculated on the assumption that the double section acts as a single integral member, i.e. the radius of gyration used to calculate the member slenderness and thus the buckling resistance moment is related to the double sections in all cases (see also Section 8.4.3).

If the sections are not continuously connected, then, in the absence of rules for stainless steel, the lateral torsional buckling resistance should be based on the increased slenderness, λ_b , as given in Section 8.4.3. The guidance in clause 4.7.13 of BS 5950-1 regarding the strength and maximum pitch of interconnections is applicable.

9 REFERENCES

1. HONEYCOMBE, R.W.K.
Steels – Microstructure and properties
Edward Arnold Ltd, 1987
2. COLOMBIER, L. and HOCHMANN, J.
Stainless and heat resisting steels
Edward Arnold Ltd, 1967
3. SEDRIKS, A.J.
Corrosion of stainless steels (2nd Edition)
John Wiley and Sons, 1996
4. Applications for stainless steel in the water industry
Water Industry Information and Guidance Note No. 4-25-02
The Steel Construction Institute, 1999
(Available from the Water Research Council, Swindon and the Nickel Development Institute, Alvechurch)
5. BADDOO, N.R., BURGAN, R. and OGDEN, R.G.
Architects' guide to stainless steel (P179)
The Steel Construction Institute, 1997
6. Stainless steel tubular handrails and balustrades (P274)
The Steel Construction Institute, 1999
7. MASONRY SUPPORT INFORMATION GROUP
Stainless steel angles for masonry support (P157)
The Steel Construction Institute, 1995
8. MASONRY SUPPORT INFORMATION GROUP
Stainless steel masonry support systems – Best practice information sheet for contractors (P297)
The Steel Construction Institute, 2000
9. MASONRY SUPPORT INFORMATION GROUP
Stainless steel masonry support systems – Best practice information sheet for specifiers (P298)
The Steel Construction Institute, 2000
10. BRITISH STANDARDS INSTITUTION
BS 5950: The structural use of steelwork in building
BS 5950-1:2000: Code of practice for design – rolled and welded sections
11. BRITISH STANDARDS INSTITUTION
BS 5950: The structural use of steelwork in building
BS 5950-8:1990: Code of practice for fire resistant design
12. BRITISH STANDARDS INSTITUTION
BS EN 10088: Stainless steels
BS EN 10088-1:1995: List of stainless steels
BS EN 10088-2:1995: Technical delivery conditions for sheet/plate and strip for general purposes
BS EN 10088-3:1995: Technical delivery conditions for semi-finished products, bars, rods and sections for general purposes

13. BRITISH STANDARDS INSTITUTION
BS 1449: Steel plate, sheet and strip
BS 1449-2:1983: Specification for stainless and heat-resisting steel plate, sheet and strip (*Withdrawn, Superseded*)
14. BRITISH STANDARDS INSTITUTION
BS EN ISO 3506:1998: Mechanical properties of corrosion-resistant stainless steel fasteners - Specifications
15. BRITISH STANDARDS INSTITUTION
BS 3100:1991 Specification for steel castings for general engineering purposes
16. BRITISH STANDARDS INSTITUTION
BS EN 10283:1999 Corrosion resistant steel castings
17. BADDOO, N.R.
Castings in construction (P172)
The Steel Construction Institute, 1996
18. BRITISH STANDARDS INSTITUTION
BS EN 10002: Tensile testing of metallic materials.
BS EN 10002-1:1990: Method of test at ambient temperature
19. BRITISH STANDARDS INSTITUTION
PD 6484:1979: Commentary on corrosion at bimetallic contacts and its alleviation
20. NICKEL DEVELOPMENT INSTITUTE
Stainless steel in swimming pool buildings
Publication Number 12010
NiDI, 1995
21. NICKEL DEVELOPMENT INSTITUTE
Advantages for Architects
NiDI, 1990
22. BRITISH STANDARDS INSTITUTION
BS 5400: Steel, concrete and composite bridges.
BS 5400-3:2000: Code of practice for design of steel bridges
23. EURO INOX
Design Manual for structural stainless steel
Euro Inox, 1993
(Available from the Nickel Development Institute)
24. THE STEEL CONSTRUCTION INSTITUTE
Advisory Desk Note No 195
New Steel Construction – Vol.5 (3) June/July 1997
25. EUROPEAN COMMITTEE FOR STANDARDIZATION
ENV 1993 Eurocode 3: Design of steel structures
ENV 1993-1-5:1997: General rules – Supplementary rules for plated planar structures without transverse loading
26. BRITISH STANDARDS INSTITUTION
BS 5950: The structural use of steelwork in building
BS 5950-5:1998: Code of practice for design of cold formed thin gauge sections

27. BRITISH STANDARDS INSTITUTION
BS ISO 68 ISO general purpose screw threads. Basic profile.
BS ISO 68-1:1998: Metric screw threads
28. BRITISH STANDARDS INSTITUTION
BS ISO 261:1998: ISO general purpose metric screw threads. General plan
29. BRITISH STANDARDS INSTITUTION
BS ISO 262:1998: ISO general purpose metric screw threads. Selected sizes for screws, bolts and nuts
30. EUROPEAN COMMITTEE FOR STANDARDIZATION
EN 1993 Eurocode 3: Design of steel structures
Draft prEN 1993-1-2: 2001 General rules - Structural fire design
4th Preliminary draft, September 2001
31. EUROPEAN COMMITTEE FOR STANDARDIZATION
DD ENV 1991 Eurocode 1: Basis of design and actions on structures
DD ENV 1991-2-2: 1996: Actions on structures exposed to fire
32. BRITISH STANDARDS INSTITUTION
DD ENV 1090: Execution of steel structures
DD ENV 1090-6:2001: Supplementary rules for stainless steel
33. BSI BRITISH STANDARDS INSTITUTION
BS EN 1011: Welding. Recommendations for welding of metallic materials
BS EN 1011-3:2000: Arc welding of stainless steels
34. BRITISH STANDARDS INSTITUTION
BS EN 288 Specification and approval of welding procedures for metallic materials,
BS EN 288-2:1992: Welding procedure specification for arc welding
35. BRITISH STANDARDS INSTITUTION
BS EN 287 Approval testing of welders – Fusion welding,
BS EN 287-1:1992: Steels
36. BRITISH STANDARDS INSTITUTION
BS EN 12072:2000 Welding consumables. Wire electrodes, wires and rods for arc welding of stainless and heat-resisting steels. Classification

10 SOURCES OF FURTHER INFORMATION

10.1 Web sites

<http://www.avestapolarit.com>

The web site of AvestaPolarit, the world's second largest producer of stainless steel, gives extensive information on grades and product forms.

<http://www.bssa.org.uk>

The British Stainless Steel Association web site provides an electronic advisory service for technical enquiries about stainless steel and a stainless steel products and services locator.

<http://www.euro-inox.org>

Euro Inox is the European Market Development Association for stainless steel. Its web site contains technical information and case studies on the use of stainless steel in architecture, building and construction, as well as other market sectors.

http://www.worldsteel.org/issf/issf_forum/

The web site of the International Stainless Steel Forum (ISSF), a specialist group of the International Iron and Steel Institute (IISI), gives general information about stainless steel as a material and its applications.

<http://www.masonrysupport.org.uk>

The web site of the Masonry Support Information Group contains design guidance and recommendations concerning good practice on the installation of stainless steel masonry support angles.

<http://www.nidi.org>

The web site of the Nickel Development Institute, an international non-profit organisation, contains metallurgical, corrosion and performance data on many grades of stainless steel.

<http://www.steel-stainless.org/architects>

This web site provides information on the design, specification, manufacture and maintenance of stainless steel architectural components. More than 20 case studies are also given.

10.2 Advisory services

Stainless Steel Advisory Service

The British Stainless Steel Association's Stainless Steel Advisory Service (SSAS) is available to answer technical and source of supply enquiries.

Tel: +44 (0)114 224 2240 (Weekdays, 09:00-12:00 and 14:00-15:00)

Fax: +44 (0)114 273 0444

Email: ssas@materials.org.uk

Nickel Development Institute

The Nickel Development Institute operates an advisory service run by metallurgical engineering consultants for technical questions about the use of nickel alloys or nickel-containing stainless steels.

Tel: +44 (0)1527 584 777

Fax: +44 (0)1527 585 562

Email: NiDI_Birmingham_UK@NiDI.org

The Steel Construction Institute

The Steel Construction Institute operates a technical advisory service on issues relating to steel in construction that is free of charge to Corporate members. Details of consultancy rates for non-members are available on request.

Tel: +44 (0) 1344 876766 (Weekdays, 09:00-17:00)

Fax: +44 (0) 1344 622944

E-mail: advisory@steel-sci.com

APPENDIX A Specifications covering stainless steel fixings and ancillary components

BS 1243:1978 Specification for metal ties for cavity wall construction

BS 5628 Code of practice for use of masonry

BS 5628-1:1992. Structural use of unreinforced masonry

BS 5628-2:2000 Structural use of reinforced and prestressed masonry

BS 5628-3:1985 Materials and components, design and workmanship

BS 5977: Lintels

BS 5977-1:1981 Method for assessment of load

BS 5977-2:1983 Specification for prefabricated lintels

BS 6178-1:1990 Joist hangers. Specification for joist hangers for building into masonry walls of domestic dwellings

BS 6744:1986 Specification for austenitic stainless steel bars for the reinforcement of concrete

BS 8297: 2000 Code of practice for design and installation of non-loadbearing precast concrete cladding

BS 8298:1994 Code of practice for design and installation of natural stone cladding and lining

prEN 845 Specification for ancillary components for masonry

prEN 845-1: 2000 Ties, tension straps, hangers and brackets

BS EN 846: Methods of test for ancillary components for masonry

BS EN 846-10: 2000 Determination of load capacity and load deflection characteristics of brackets

BS EN ISO 3506: 1998 Mechanical properties of corrosion-resistant stainless steel fasteners

DD 140: Wall ties

DD 140-1:1986 Methods of test for mortar joint and timber frame connections

DD 140-2:1987 Recommendations for design of wall ties

(Note: This publication is a draft for development and should not be regarded as a British Standard)

Manual of Contract Documents for Highway Works,

Volume 1, Specification for Highway Works, Series 1700: Structural concrete

The Stationery Office, 2001

APPENDIX B Limits on cross-sections

The design provisions in Sections 3 and 4 should only be applied to cross-sections within the range of width-to-thickness ratios given in Table B.1. These limits define the range of width-to-thickness ratios for which sufficient experience and verification by testing is available. These limits are higher than would normally be used in practice and are therefore not in any way onerous. For structural efficiency, lower limits are generally used. Furthermore, in cases where stainless steel is used for aesthetic purposes, smaller limits need to be set in order to eliminate visual distortions (see Section 3.1).

Table B.1 *Maximum width-to-thickness ratios*

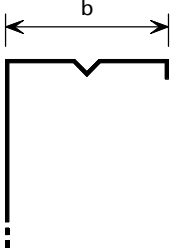
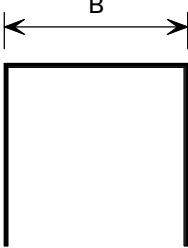
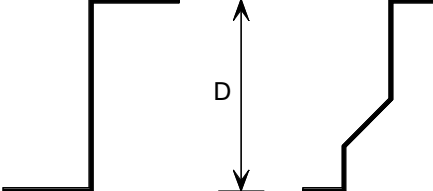
a) Flat element connected to a web along one edge with the other edge unsupported	$b/t \leq 50$	
b) Flat element connected along both edges to webs or flanges:	$B/t \leq 400$	
	$D/t \leq 400$	

Note: Flat elements supported as in (a) above with b/t ratios greater than approximately 30 and flat elements supported otherwise with b/t ratios greater than approximately 75 are likely to develop visual distortion at serviceability design loads.

APPENDIX C Sections with large internal corner radii

In the design tables, all the gross and effective section properties were calculated with internal corner radii, r_i , taken as two times the section thickness, i.e. $r_i = 2t$; this provides conservative design data for sections with smaller internal corner radii.

However, for sections with internal corner radii larger than two times the section thickness, the section properties and the member capacities in the tables need to be modified. The values may be reduced conservatively as follows:

$$\begin{aligned} A_g &= K_1 A_{g,D} & P_t &= K_1 P_{t,D} & M_c &= K_2 M_{c,D} \\ P_c &= K_1 P_{c,D} & M_b &= K_2 M_{b,D} \\ I &= K_2 I_D & Z &= K_2 Z_D \end{aligned}$$

where A_g , I , Z , P_t , M_c , P_c and M_b are the required section properties and member capacities of sections with $r_i > 2t$, i.e. $r_m > 2.5t$, where r_m is the average corner radius (mid-line).

$A_{g,D}$, I_D , Z_D , $P_{t,D}$, $M_{c,D}$, $P_{c,D}$ and $M_{b,D}$ are section properties and member capacities of the same section given in the design tables (i.e. with $r_i = 2t$, and $r_m = 2.5t$).

The factors K_1 and K_2 are given by:

$$\begin{aligned} K_1 &= \frac{1-d}{1-d_D} & K_2 &= \frac{1-2d}{1-2d_D} \\ \text{and } d &= 0.43 \frac{\sum_{j=1}^n r_{m,j}}{\sum_{i=1}^q b_i} & d_D &= 0.43 \frac{\sum_{j=1}^n 2.5t}{\sum_{i=1}^q b_i} \end{aligned}$$

It should be noted that K_1 is the correction factor for design data in relation to area and it is also applicable to both the compression resistance and the tension capacity of a member. K_2 is the correction factor for design data in relation to second moment of area and it is also applicable to the moment capacity and the buckling resistance moment of a member. The definition of δ is taken from Section 3.5.

For example, for a Grade 1.4301 (304) stainless steel single channel $400 \times 150 \times 15$ mm with internal corner radius $r_i = 2.5t$ and $r_m = 3t$, i.e. $r_m = 45$ mm, the section properties and the member capacities of the sections may be evaluated as shown in Table C.1.

Table C.1 *Example of reduction in section properties and member capacities for sections with larger internal corner radii*

Properties and capacities		Data from design tables ($r_i = 2t$)	Relevant correction factor	Corrected values ($r_i = 2.5t$)	
A_g	(cm ²)	95.7	K_1	94.7	
I_x	(cm ⁴)	21100	K_2	20651	
Z_x	(cm ³)	1055	K_2	1033	
P_{cy} ($L_E = 2.0m$)	(kN)	1940.0	K_1	1920.4	
M_b ($L_E = 2.0 m$)	(kNm)	269.0	K_2	263.3	
where: K_1	=	0.9899	K_2	=	0.9787
δ_D	=	0.04813	δ	=	0.05776

Similarly, for the same cross-section with $r_i = 3 t$, $K_1 = 0.9797$ and $K_2 = 0.9574$. Thus, the compression and bending resistances of the member given in the design tables should be reduced by about 2% and 4% respectively in the above example.

[Discuss me ...](#)

DESIGN EXAMPLES

This Section gives four design examples that illustrate the application of the design rules. The examples are:

Design example 1

A cold formed angle with a Class 4 slender cross-section subject to axial compression.

Design example 2

A cold formed channel subject to bending with intermediate lateral restraints to the compression flange. Lateral torsional buckling between intermediate lateral restraints is critical.

Design example 3

A fabricated I beam subject to combined axial compression and bending.

Design example 4

A rectangular hollow section subject to combined axial compression and bending with 30 minutes fire resistance.

The I beam and angle are grade 1.4301 (304) and the channel and rectangular hollow section are grade 1.4401 (316).

The references in the margin of the design examples are to text sections and expressions/equations in this publication, unless specifically noted otherwise.

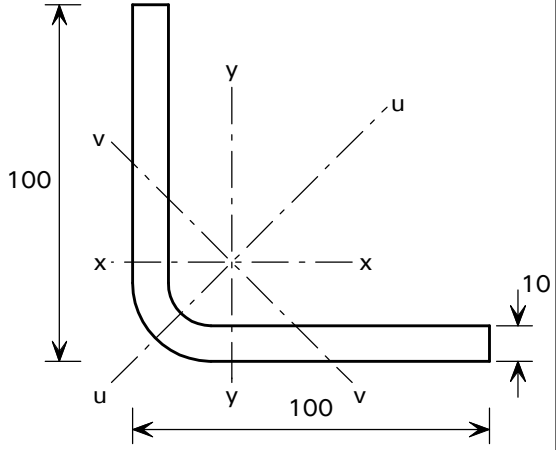
 <p>The Steel Construction Institute</p> <p>Silwood Park, Ascot, Berks SL5 7QN Telephone: (01344) 623345 Fax: (01344) 622944</p> <p>CALCULATION SHEET</p>	Job No. OSM459	Sheet 1 of 4	Rev
	Job Title Structural design of stainless steel		
	Subject Design example 1		
	Client SCI	Made by SMH	Date Aug 2001
	Checked by NRB	Date Aug 2001	
<p>DESIGN EXAMPLE 1: STRUT (EQUAL ANGLE)</p> <p>Design a cold formed angle subject to axial compression in grade 1.4301 (304) stainless steel. The angle is welded around its profile at each end.</p> <p>The length of the strut is 1.5 m</p> <p>Factored compressive force = 230 kN</p> <p>Use grade 1.4301 (304), 0.2% proof stress = 210 N/mm²</p> <p>Take p_y as the 0.2% proof stress, i.e. $p_y = 210 \text{ N/mm}^2$</p> <p>$E = 200,000 \text{ N/mm}^2$ and $G = 76,900 \text{ N/mm}^2$</p> <p>Try a cold formed angle 100 × 100 × 10</p> <p>Section properties</p> <p>$A_g = 17.9 \text{ cm}^2$</p> <p>$r_u = 3.99 \text{ cm}$ $r_v = 1.78 \text{ cm}$</p> <p>$I_u = 285.8 \text{ cm}^4$ $I_v = 57 \text{ cm}^4$</p> <p>$u_0 = 3.29 \text{ cm}$</p> <p>$J = 5.976 \text{ cm}^4$ $H = 36.85 \text{ cm}^6$</p>  <p>Classification of cross-section</p> <p>$e = 1.13$</p> <p>$b = d = 100$ $\frac{b}{t} = 10$, $\frac{b+d}{t} = 20$</p> <p>The limits for semi-compact sections are, $\frac{b}{t}$ and $\frac{d}{t} \leq 11e = 12.43$</p> <p>and $\frac{b+d}{t} \leq 16.8e = 18.98$ ∴ Section is Class 4 slender</p> <p>Effective width of slender elements</p> <p>For legs of single angles under uniform compression</p> <p>$\rho =$ the lesser of $\frac{19}{\frac{b}{t} + 8}$ and $\frac{28.8}{\frac{b+d}{t} + 12}$</p>			
		Table 2.2	
		Section 2.2.2	
		Design Table 6	
		Section 3.8	
		Table 3.1	
		Table 3.1	
		Table 3.2	

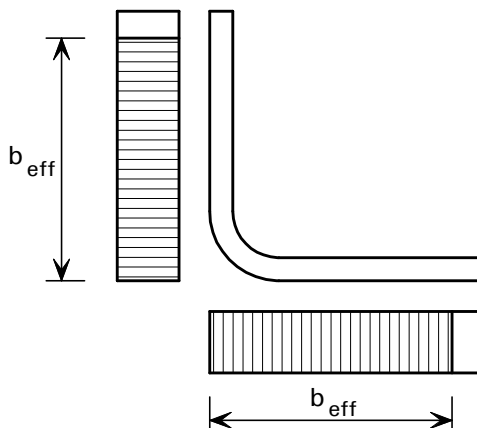
 <p>The Steel Construction Institute Silwood Park, Ascot, Berks SL5 7QN Telephone: (01344) 623345 Fax: (01344) 622944</p> <p>CALCULATION SHEET</p>	Job No. OSM459	Sheet 2 of 4	Rev
	Job Title Structural design of stainless steel		
	Subject Design example 1		
	Client SCI	Made by SMH	Date Aug 2001
	Checked by NRB	Date Aug 2001	
$\frac{19}{\frac{b}{te} + 8} = \frac{19}{\frac{10}{1.13} + 8} = 1.13$ $\frac{28.8}{\frac{b+d}{te} + 12} = \frac{28.8}{\frac{20}{1.13} + 12} = 0.97$ <p>$\therefore \rho = 0.97$</p> <p>$\therefore b_{\text{eff}} = 0.97 \times d = 97 \text{ mm}$</p> <p>$\therefore A_{\text{eff}} = 1790 - (2 \times 3 \times 10) = 1730 \text{ mm}^2$</p>  <p>Local capacity of the cross-section</p> <p>For Class 4 cross-sections, $P_{\text{sq}} = A_{\text{eff}} p_y = 1730 \times 210 \times 10^{-3} = 363.3 \text{ kN}$</p> <p>Design compressive force = 230 kN, \therefore cross section resistance is OK</p> <p>Member buckling due to compression</p> <p>The member can fail by flexural buckling about the minor axis, or by torsional-flexural buckling.</p> <p>Buckling resistance, $P_c = \chi \beta_c A_g p_y$</p> <p>$\beta_c = \frac{A_{\text{eff}}}{A_g}$ for Class 4 cross-sections, $\therefore \beta_c = 0.966$</p> <p>Non dimensional slenderness, $\bar{\lambda} = \sqrt{\frac{P_{\text{sq}}}{P_E}}$</p> <p>Where P_E is the value of P_v and P_{uz} that gives the lowest reduction factor, χ.</p> <p>It is assumed that $L_{Eu} = L_{Ev} = L_{Ez} = L$</p>			
			Section 4.3.2 Eq. 4.7 Section 4.3.3 Eq. 4.8 Eq. 4.9

 <p>The Steel Construction Institute Silwood Park, Ascot, Berks SL5 7QN Telephone: (01344) 623345 Fax: (01344) 622944</p> <p>CALCULATION SHEET</p>	Job No. OSM459	Sheet 3 of 4	Rev
	Job Title Structural design of stainless steel		
	Subject Design example 1		
	Client SCI	Made by SMH	Date Aug 2001
	Checked by NRB	Date Aug 2001	
$P_u = \frac{p^2 EI_u}{L_{Eu}^2} = \frac{p^2 \times 200,000 \times 285.8 \times 10^4}{1500^2 \times 1000} = 2507 \text{ kN}$			Eq. 4.10
$P_v = \frac{p^2 EI_v}{L_{Ev}^2} = \frac{p^2 \times 200,000 \times 57.0 \times 10^4}{1500^2 \times 1000} = 500 \text{ kN}$			Eq. 4.11
$P_z = \frac{1}{r_0^2} \left[\frac{p^2 EH}{L_{Ez}^2} + GJ \right]$			Eq. 4.12
$r_0 = \sqrt{r_u^2 + r_v^2 + u_0^2} = \sqrt{3.99^2 + 1.78^2 + 3.29^2} = 5.47 \text{ cm} = 54.7 \text{ mm}$			Eq. 4.15
$P_z = \frac{1}{54.7^2} \left[\frac{p^2 \times 200,000 \times 36.85 \times 10^6}{1500^2} + 76,900 \times 5.976 \times 10^4 \right] = 1547 \text{ kN}$			
$P_{uz} = \frac{1}{2b} \left[(P_u + P_z) - \sqrt{(P_u + P_z)^2 - 4bP_uP_z} \right]$			Eq. 4.13
$b = 1 - \left(\frac{u_0}{r_0} \right)^2 = 1 - \left(\frac{32.9}{54.7} \right)^2 = 0.638$			Eq. 4.14
$P_{uz} = \frac{\left[(2507 + 1547) - \sqrt{(2507 + 1547)^2 - 4 \times 0.638 \times 2507 \times 1547} \right]}{2 \times 0.638} = 1173 \text{ kN}$			
For flexural buckling, $P_E = P_v = 500 \text{ kN}$			
$\bar{I} = \frac{\sqrt{363.3}}{500} = 0.852$			Eq. 4.9
For flexural buckling of a cold formed open section subject to axial compression, by linear interpolation of the values in Table 4.1, $\chi = 0.691$.			Table 4.1
For torsional-flexural buckling, $P_E = P_{uz} = 1173 \text{ kN}$			
$\bar{I} = \frac{\sqrt{363.3}}{1173.3} = 0.556$			Eq. 4.9
For torsional-flexural buckling of a cold formed open section subject to axial compression, by linear interpolation of the values in Table 4.1, $\chi = 0.858$			Table 4.1
0.858 > 0.691, ∴ member will fail in the flexural buckling mode.			
$P_c = 0.691 \times 0.966 \times 1790 \times 210 = 251 \text{ kN}$			Eq. 4.8
Design compressive force = 230 kN, ∴ Section is OK for member buckling			

 <p>The Steel Construction Institute</p> <p>Silwood Park, Ascot, Berks SL5 7QN Telephone: (01344) 623345 Fax: (01344) 622944</p> <p>CALCULATION SHEET</p>	Job No. OSM459	Sheet 4 of 4	Rev
	Job Title Structural design of stainless steel		
	Subject Design example 1		
	Client SCI	Made by SMH	Date Aug 2001
	Checked by NRB	Date Aug 2001	
<p>Interaction of axial compression and bending due to shift in neutral axis of the slender cross-section</p> <p>An interaction check is required to take account of the additional moments induced in the member due to the shift of the centroid of the effective cross-section compared to the gross cross-section</p> <p>Local Capacity Check</p> $\frac{F_c}{A_{\text{eff}} p_y} + \frac{F_c e_x}{M_{\text{cx}}} + \frac{F_c e_y}{M_{\text{cy}}} \leq 1$ <p>$e_x = e_y = 0.743 \text{ mm}$</p> <p>It is necessary to calculate the section modulus of the effective cross-section, i.e. an equal leg angle with $d = 97 \text{ mm}$</p> <p>$Z_{\text{effx}} = Z_{\text{effy}} = 22.096 \text{ cm}^3$ (calculation not shown here)</p> $\frac{230 \times 10^3}{1730 \times 210} + \frac{230 \times 10^3 \times 0.743}{210 \times 22096} + \frac{230 \times 10^3 \times 0.743}{210 \times 22096} \leq 1.00$ <p>$0.633 + 0.037 + 0.037 = 0.707 \leq 1.00$</p> <p>The local capacity of the section is OK</p> <p>Check overall buckling capacity</p> $\frac{F_c}{P_c} + \frac{F_c e_x}{p_y Z_{\text{x eff}}} + \frac{F_c e_y}{p_y Z_{\text{y eff}}} \leq 1$ $\frac{230 \times 10^3}{251 \times 10^3} + \frac{230 \times 10^3 \times 0.743}{210 \times 22096} + \frac{230 \times 10^3 \times 0.743}{210 \times 22096} \leq 1.00$ <p>$0.916 + 0.037 + 0.037 = 0.990 \leq 1.00$</p> <p>$\therefore$ The overall buckling resistance of the section is OK</p>		<p>Section 3.8.4 and Figure 8.2</p> <p>Eq. 4.62</p> <p>Design Table 13</p> <p>Eq. 4.65</p>	

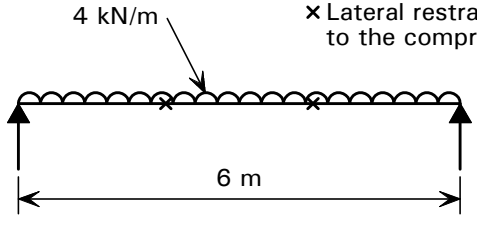
 <p>The Steel Construction Institute Silwood Park, Ascot, Berks SL5 7QN Telephone: (01344) 623345 Fax: (01344) 622944</p> <p>CALCULATION SHEET</p>	Job No. OSM459	Sheet 1 of 4	Rev								
	Job Title Structural design of stainless steel										
	Subject Design example 2										
	Client SCI	Made by SMH	Date Aug 2001								
	Checked by NRB	Date Aug 2001									
<p>DESIGN EXAMPLE 2 – UNRESTRAINED BEAM (CHANNEL)</p> <p>Design a cold formed channel subject to bending in grade 1.4401 (316) stainless steel.</p>  <p>Loads</p> <p>Dead loads: UDL 0.196 kN/m (self weight)</p> <p>Imposed loads: UDL 4 kN/m</p> <p>Factored (design) loads</p> <p>Dead load factor = 1.4</p> <p>Imposed load factor = 1.6</p> <p>Factored dead load = $1.4 \times 0.196 = 0.274$ kN/m</p> <p>Factored vertical imposed load = $1.6 \times 4 = 6.4$ kN/m</p> <p>Maximum bending moment due to vertical loads</p> $= \frac{(0.274 + 6.4) \times 6^2}{8} = 30.0 \text{ kNm}$ <p>Maximum shear due to vertical loads</p> $= \frac{(0.274 + 6.4) \times 6}{2} = 20.0 \text{ kN}$ <p>Use grade 1.4401 (316), 0.2% proof stress = 220 N/mm²</p> <p>Take p_y as the 0.2% proof stress, i.e. $p_y = 220$ N/mm²</p> <p>$E = 200,000$ N/mm²</p> <p>Try a 200 × 75 × 8 cold formed channel section</p> <p>Section properties</p> <table> <tr> <td>$I_x = 1385 \text{ cm}^4$</td> <td>$I_y = 126.5 \text{ cm}^4$</td> </tr> <tr> <td>$Z_x = 138.6 \text{ cm}^3$</td> <td>$S_x = 169.2 \text{ cm}^3$</td> </tr> <tr> <td>$r_x = 7.39 \text{ cm}$</td> <td>$r_y = 2.23 \text{ cm}$</td> </tr> <tr> <td>$A_g = 25.3 \text{ cm}^2$</td> <td></td> </tr> </table>				$I_x = 1385 \text{ cm}^4$	$I_y = 126.5 \text{ cm}^4$	$Z_x = 138.6 \text{ cm}^3$	$S_x = 169.2 \text{ cm}^3$	$r_x = 7.39 \text{ cm}$	$r_y = 2.23 \text{ cm}$	$A_g = 25.3 \text{ cm}^2$	
$I_x = 1385 \text{ cm}^4$	$I_y = 126.5 \text{ cm}^4$										
$Z_x = 138.6 \text{ cm}^3$	$S_x = 169.2 \text{ cm}^3$										
$r_x = 7.39 \text{ cm}$	$r_y = 2.23 \text{ cm}$										
$A_g = 25.3 \text{ cm}^2$											
			BS 5950-1 Table 2								
			Table 2.2								
			Table 2.4								
			Design Table 4								

 <p>The Steel Construction Institute</p> <p>Silwood Park, Ascot, Berks SL5 7QN Telephone: (01344) 623345 Fax: (01344) 622944</p> <p>CALCULATION SHEET</p>	Job No. OSM459	Sheet 2 of 4	Rev
	Job Title Structural design of stainless steel		
	Subject Design example 2		
	Client SCI	Made by SMH	Date Aug 2001
	Checked by NRB	Date Aug 2001	
<p>Classification of cross-section</p> <p>$d = 200 - 6t = 152$ mm (Assuming internal radius of $2t$)</p> <p>$b = 75$ mm</p> <p>$e = 1.10$</p> <p>Compression flange $\frac{b}{t} = \frac{75}{8} = 9.38$</p> <p>For Class 2 compact sections, $\frac{b}{t} \leq 9.5e = 10.45$</p> <p>$\therefore$ Flange is at least compact.</p> <p>Web subject to bending $\frac{d}{t} = \frac{152}{8} = 19.0$</p> <p>Neutral axis at mid depth – for Class 2 compact sections $\frac{d}{t} \leq 54e = 59.4$</p> <p>$\therefore$ Web is at least compact</p> <p>Classification of cross-section: at least compact</p>			Section 3.8 Table 3.1
<p>Shear capacity</p> <p>Maximum shear at beam end = 20.0 kN</p> <p>Shear capacity $P_v = 0.6 \times p_y \times A_v$</p> <p>For a channel, load parallel to the web, $A_v = t \times D$</p> <p>$P_v = 0.6 \times 220 \times 8 \times 200 = 211$ kN</p> <p>Design shear force = 20.0 kN, shear capacity of cross-section is OK</p>			Section 4.4.1 Eq. 4.18
<p>Moment capacity</p> <p>$\frac{F_v}{P_v} = \frac{20}{211} = 0.09 < 0.6$</p> <p>$\therefore$ Moment capacity does not need to be reduced for the effects of high shear.</p> <p>$\therefore M_c = p_y S$ but not more than $1.2 Z p_y$</p> <p>$p_y S = 220 \times 169.2 \times 10^{-3}$ kNm = 37.2 kNm</p> <p>$1.2 Z p_y = 1.2 \times 13.86 \times 10^4 \times 220 = 36.6$ kNm</p> <p>$\therefore M_{cx} = 36.6$ kNm</p> <p>Design moment = 30.0 kNm, \therefore Moment capacity of cross-section is OK</p>			Section 4.4.2 Eq. 4.19

 <p>The Steel Construction Institute Silwood Park, Ascot, Berks SL5 7QN Telephone: (01344) 623345 Fax: (01344) 622944</p> <p>CALCULATION SHEET</p>	Job No. OSM459	Sheet 3 of 4	Rev
	Job Title Structural design of stainless steel		
	Subject Design example 2		
	Client SCI	Made by SMH	Date Aug 2001
	Checked by NRB	Date Aug 2001	
<p>Lateral torsional buckling resistance</p> <p>For satisfactory resistance to lateral torsional buckling,</p> $M_x \leq M_b/m_{LT}$ <p>Eq. 4.26</p> $M_b = \chi_{LT} \beta_w S_x p_y$ <p>Eq. 4.27</p> <p>$\beta_w = 1$ for compact cross-sections</p> $\bar{I}_{LT} = \frac{I_{LT}}{p} \sqrt{\frac{p_y}{E}} = \frac{I_{LT}}{p} \sqrt{\frac{220}{200,000}} = \lambda_{LT} \times 1.055 \times 10^{-2}$ <p>Eq. 4.28</p> $\lambda_{LT} = uvI\sqrt{b_w}$ <p>Eq. 4.29</p> $\lambda = L_E/r_y$ <p>Eq. 4.30</p> <p>Cross members provide lateral restraints at 2 m centres</p> <p>$\therefore L_E = 2000$ mm</p> $\lambda = 2000/22.3 = 89.7$ <p>From section property table, Design Table 4:</p> $u = 0.934 \quad x = 17.9$ $\Rightarrow \frac{I}{x} = \frac{89.7}{17.9} = 5.01$ $v = \frac{1}{\left[1 + 0.05\left(\frac{I}{x}\right)^2\right]^{0.25}} = \frac{1}{\left[1 + 0.05\left(\frac{89.7}{17.9}\right)^2\right]^{0.25}} = 0.816$ <p>BS 5950-1 cl 4.3.6.7</p> $I_{LT} = 0.934 \times 0.816 \times 89.7 \times 1.00 = 68.4$ $\bar{I}_{LT} = 68.4 \times 1.055 \times 10^{-2} = 0.721 > 0.4$ <p>\therefore Lateral torsional buckling should be considered.</p> <p>For cold formed section, with $\bar{I}_{LT} = 0.721$, by linear interpolation of values in Table 4.2, $c_{LT} = 0.837$</p> <p>Table 4.2</p> $M_b = 0.837 \times 1.00 \times 220 \times 169.2 \times 10^3 = 31.2 \text{ kN}$			Section 4.4.4

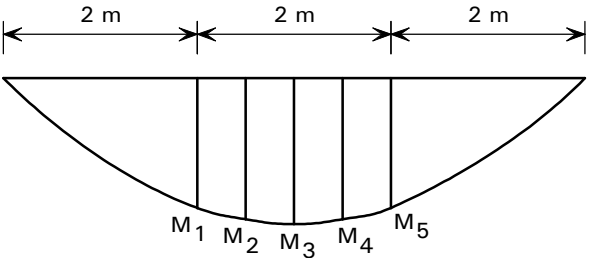
 <p>The Steel Construction Institute</p> <p>Silwood Park, Ascot, Berks SL5 7QN Telephone: (01344) 623345 Fax: (01344) 622944</p> <p>CALCULATION SHEET</p>	Job No. OSM459	Sheet 4 of 4	Rev
	Job Title Structural design of stainless steel		
	Subject Design example 2		
	Client SCI	Made by SMH	Date Aug 2001
	Checked by NRB	Date Aug 2001	
<p>Calculate m_{LT}</p>  <p>Lateral restraints divide the beam into three sections. By inspection the middle section is critical. Divide mid section into 4 No. equal segments and calculate moments at segment intersections.</p> <p> $M_1 = M_5 = 26.7 \text{ kNm}$ $M_2 = M_4 = 29.2 \text{ kNm}$ $M_3 = M_{\max} = 30.0 \text{ kNm}$ </p> $m_{LT} = 0.2 + \frac{0.15 M_2 + 0.5 M_3 + 0.15 M_4}{M_{\max}}$ $m_{LT} = 0.2 + \frac{0.15 \times 29.2 + 0.5 \times 30.0 + 0.15 \times 29.2}{30.0} = 0.99$ <p> $M_b/m_{LT} = 31.2/0.99 = 31.5 \text{ kNm}$ $M_x = 30.0 \text{ kNm}, \therefore M_x < M_b/m_{LT}$ </p> <p>\therefore Lateral torsional buckling resistance of member is OK</p>			
			BS 5950-1 Table 18

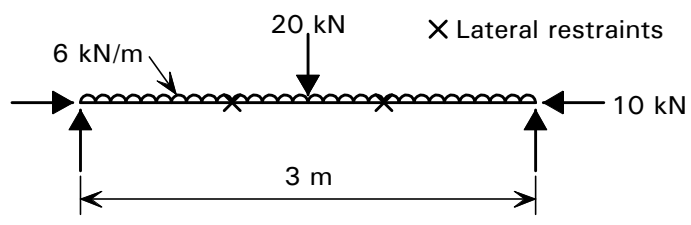
 <p>The Steel Construction Institute Silwood Park, Ascot, Berks SL5 7QN Telephone: (01344) 623345 Fax: (01344) 622944</p> <p>CALCULATION SHEET</p>	Job No. OSM459	Sheet 1 of 11	Rev
	Job Title Structural design of stainless steel		
	Subject Design example 3		
	Client SCI	Made by SMH	Date Aug 2001
	Checked by NRB	Date Aug 2001	
<p>DESIGN EXAMPLE 3: BEAM-COLUMN (FABRICATED I BEAM)</p> <p>Design a fabricated I beam subject to axial compression and bending in grade 1.4301 (304) stainless steel.</p>  <p>× Cross member provide restraint against lateral torsional buckling and flexural buckling at 1 m centres. The member is torsionally and laterally restrained at each end.</p> <p>Loads</p> <p>Dead load: UDL 0.47 kN/m (self weight) Imposed load: UDL 6 kN/m Point load 20 kN Axial load 10 kN</p> <p>Dead load factor = 1.4 Imposed load factor = 1.6</p> <p>Factored dead load = $1.4 \times 0.47 = 0.66$ kN/m Factored vertical imposed load = $1.6 \times 6 = 9.6$ kN/m and $1.6 \times 20 = 32$ kN Factored axial imposed load = $1.6 \times 10 = 16$ kN</p> <p>Maximum bending moment = $\frac{32 \times 3}{4} + \frac{(0.66 + 9.6) \times 3^2}{8} = 35.5$ kNm</p> <p>Maximum shear = $\frac{32}{2} + \frac{(0.66 + 9.6) \times 3}{2} = 31.4$ kN</p> <p>Use grade 1.4301 (304), 0.2% proof stress = 210 N/mm² Take p_y as the 0.2% proof stress, i.e. $p_y = 210$ N/mm² $E = 200,000$ N/mm² and $G = 76,900$ N/mm²</p>			
			BS 5950-1 Table 2
			Table 2.2
			Section 2.2.2

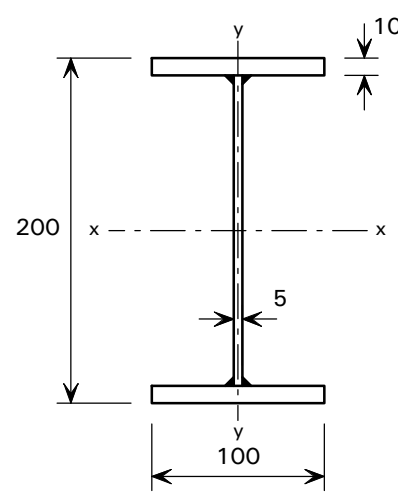
 <p>The Steel Construction Institute</p> <p>Silwood Park, Ascot, Berks SL5 7QN Telephone: (01344) 623345 Fax: (01344) 622944</p> <p>CALCULATION SHEET</p>	Job No. OSM459	Sheet 2 of 11	Rev
	Job Title Structural design of stainless steel		
	Subject Design example 3		
	Client SCI	Made by SMH	Date Aug 2001
	Checked by NRB	Date Aug 2001	
<p>Try a fabricated I beam:</p> <p>Section properties</p> <p> $I_x = 20.5 \times 10^6 \text{ mm}^4$ $I_y = 1.67 \times 10^6 \text{ mm}^4$ $Z_x = 20.5 \times 10^4 \text{ mm}^3$ $S_x = 23.05 \times 10^4 \text{ mm}^3$ $A_g = 2900 \text{ mm}^2$ $r_x = 84.08 \text{ mm}$ $r_y = 23.98 \text{ mm}$ </p>  <p>Classification of cross-section</p> <p> $d = 200 - 20 = 180 \text{ mm}$ $b = 50 - 2.5 = 47.5 \text{ mm}$ $e = 1.13$ </p> <p>Outstand of compression flange $\frac{b}{T} = \frac{47.5}{10} = 4.75$</p> <p>For Class 2 compact sections, $\frac{b}{T} \leq 8.5 e = 9.605$</p> <p>$\therefore$ Flange is at least Class 2 compact</p> <p>Web subject to bending and axial compression $\frac{d}{t} = \frac{180}{5} = 36$</p> <p>Calculate r_1,</p> $r_1 = \frac{F_c}{d t p_y} = \frac{16000}{180 \times 5 \times 210} = 0.085$ <p>F_c is compressive, $\therefore r_1$ is positive</p> <p>For Class 2 compact sections, $\frac{d}{t} \leq \frac{54e}{r_1 + 1} = 56.2$</p> <p>$\therefore$ Web is at least class 2 compact. Classification of overall section: at least compact.</p>			
			Section 3.8
			Table 3.1
			Section 3.8.3
			Table 3.1

 <p>The Steel Construction Institute Silwood Park, Ascot, Berks SL5 7QN Telephone: (01344) 623345 Fax: (01344) 622944</p> <p>CALCULATION SHEET</p>	Job No. OSM459	Sheet 3 of 11	Rev
	Job Title Structural design of stainless steel		
	Subject Design example 3		
	Client SCI	Made by SMH	Date Aug 2001
	Checked by NRB	Date Aug 2001	
<p>Shear lag</p> <p>Effect of shear lag may be neglected provided that:</p> <p>For outstand elements $b \leq L/20$</p> <p>L = length between points of zero moment = 3 m</p> <p>outstand elements $b = 47.5$ mm, $L/20 = 150$ mm $\therefore b < L/20$</p> <p>\therefore shear lag can be neglected</p>			Section 3.6
<p>Flange curling</p> $u = \frac{2.3 p_a^2 b_s^4}{E^2 T^2 \bar{y}}$ <p>p_a = average longitudinal stress in flange = 210 N/mm² (max possible value)</p> <p>$b_s = 47.5$ mm</p> <p>$\bar{y} = 95$ mm</p> $\therefore u = \frac{2.3 \times 210^2 \times 47.5^4}{200,000^2 \times 10^2 \times 95} = 1.4 \times 10^{-3} \text{ mm}$ <p>Effect of flange curling should be considered where u exceeds 5% of the depth of the section, i.e. $0.05 \times 200 = 10$ mm</p> <p>\therefore flange curling is negligible</p>			Section 3.7 Eq. 3.5
<p>Shear capacity</p> $P_v = 0.6 p_y A_v$ $A_v = t d$ $= 5 \times 180 = 900 \text{ mm}^2$ $\therefore P_v = 0.6 \times 210 \times 900 = 113.4 \text{ kN}$ <p>Design shear force, $F_v = 31.4$ kN, \therefore section is OK in shear</p>			Section 4.4.1 Eq. 4.18
<p>Shear buckling</p> <p>Shear buckling of webs should be considered when $d/t \geq 39.5\epsilon$</p> $d/t = 36 < 39.5\epsilon, \therefore$ shear buckling can be neglected.			Section 4.4.5

 <p>The Steel Construction Institute</p> <p>Silwood Park, Ascot, Berks SL5 7QN Telephone: (01344) 623345 Fax: (01344) 622944</p> <p>CALCULATION SHEET</p>	Job No. OSM459	Sheet 4 of 11	Rev
	Job Title Structural design of stainless steel		
	Subject Design example 3		
	Client SCI	Made by SMH	Date Aug 2001
	Checked by NRB	Date Aug 2001	
<p>Moment capacity</p> $\frac{F_v}{P_v} = \frac{31.4}{113.4} = 0.277 < 0.6$ <p>∴ Moment capacity does not need to be reduced for the effects of high shear.</p> $M_{cx} = p_y S_x \text{ but not more than } 1.2 p_y Z_x \text{ for Class 1 or Class 2 cross-sections}$ $p_y S_x = 210 \times 23.05 \times 10^4 \times 10^{-6} = 48.4 \text{ kNm}$ $1.2 p_y Z_x = 1.2 \times 210 \times 20.5 \times 10^4 \times 10^{-6} = 51.7 \text{ kNm}$ <p>∴ $M_{cx} = 48.4 \text{ kNm}$</p> <p>Maximum design bending moment, $M_x = 35.5 \text{ kNm}$, ∴ Section is OK</p>			Section 4.4.2
<p>Lateral torsional buckling resistance</p> $M_x \leq \frac{M_b}{m_{LT}} \text{ where } M_b = \chi_{LT} \beta_w S_x p_y$ $\beta_w = 1 \text{ for Class 1 or Class 2 cross-sections}$ $\bar{I}_{LT} = \frac{I_{LT}}{p} \sqrt{\frac{p_y}{E}} = \frac{I_{LT}}{p} \sqrt{\frac{210}{200,000}} = \lambda_{LT} \times 1.03 \times 10^{-2}$ $\lambda_{LT} = uvI \sqrt{b_w}$ $\lambda = L_E/r_y$ <p>Cross members provide lateral restraints at 1 m centres</p> <p>∴ $L_E = 1000 \text{ mm}$</p> $\lambda = 1000/23.98 = 41.7$ $u = \left(\frac{4 S_x^2 g}{A_g^2 d_s^2} \right)^{0.25}$ $d_s = \text{distance between shear centres of flanges} = 200 - 10 = 190 \text{ mm}$ $S_x = 23.05 \times 10^4 \text{ mm}^3$ $\gamma = (1 - I_y/I_x) = (1 - (1.67 \times 10^6)/(20.5 \times 10^6)) = 0.92$ $A_g = 2900 \text{ mm}^2$ <p>Hence $u = \left(\frac{4 \times (23.05 \times 10^4)^2 \times 0.92}{2900^2 \times 190^2} \right)^{0.25} = 0.896$</p>			Section 4.4.4 Eq. 4.26 & 4.27 Eq. 4.28 Eq. 4.29 Eq. 4.30 BS 5950-1 cl B.2.3

 <p>The Steel Construction Institute Silwood Park, Ascot, Berks SL5 7QN Telephone: (01344) 623345 Fax: (01344) 622944</p> <p>CALCULATION SHEET</p>	Job No. OSM459	Sheet 5 of 11	Rev
	Job Title Structural design of stainless steel		
	Subject Design example 3		
	Client SCI	Made by SMH	Date Aug 2001
	Checked by NRB	Date Aug 2001	
$x = 0.566d_s \left(\frac{A_g}{J} \right)^{0.5}$ $J = \frac{1}{3} (T_1^3 b_1 + T_2^3 b_2 + t_w^3 d) = \frac{1}{3} (2 \times 10^3 \times 100 + 5^3 \times 180) = 74.2 \times 10^3 \text{ mm}^4$ $\therefore x = 0.566 \times 190 \times \left(\frac{2900}{74.2 \times 10^3} \right)^{0.5} = 21.26$ $\frac{I}{x} = \frac{41.7}{21.26} = 1.96, \Rightarrow \nu = 0.96$ <p>Lateral restraints divide the beam into three sections, the middle section is critical:</p> $\therefore \lambda_{LT} = uvI \sqrt{b_w} = 0.896 \times 0.96 \times 41.7 = 35.87$ $\therefore \bar{I}_{LT} = 35.87 \times 1.03 \times 10^{-2} = 0.369$ <p>As $\bar{I}_{LT} < 0.4$, lateral torsional buckling can be discounted.</p> <p>i.e. $M_b = M_{cx} = 48.4 \text{ kNm}$</p> <p>Compression resistance of the cross-section</p> <p>Local capacity of cross-section</p> <p>For a non-slender cross-section: $P_{sq} = A_g p_y$</p> $P_{sq} = 2900 \times 210 \times 10^{-3} = 609 \text{ kN}$ <p>Design compressive force, $F_c = 16 \text{ kN}$ \therefore cross section is OK for compression</p> <p>Member buckling due to compression</p> <p>Compression resistance, $P_c = \chi \beta_c A_g p_y$</p> <p>$\beta_c = 1$ for non-slender sections</p> <p>Non dimensional slenderness, $\bar{I} = \sqrt{\frac{P_{sq}}{P_E}}$</p> <p>where P_E is the value of P_x, P_y and P_z that gives the lowest reduction factor, χ.</p> <p>The section will not fail in torsional flexural buckling because the shear centre coincides with the centroid of the section.</p>			<p>BS 5950-1 cl B.2.3</p> <p>Eq. 4.17</p> <p>BS 5950-1 Table 19</p> <p>Table 4.2</p> <p>Section 4.3.2 Eq 4.6</p> <p>Section 4.3.3 Eq. 4.8 Eq. 4.9</p>

 <p>The Steel Construction Institute</p> <p>Silwood Park, Ascot, Berks SL5 7QN Telephone: (01344) 623345 Fax: (01344) 622944</p> <p>CALCULATION SHEET</p>	Job No. OSM459	Sheet 6 of 11	Rev
	Job Title Structural design of stainless steel		
	Subject Design example 3		
	Client SCI	Made by SMH	Date Aug 2001
	Checked by NRB	Date Aug 2001	
<p>Cross members provide lateral restraint at 1 m centres</p> <p>$\therefore L_y = 1000 \text{ mm}$, take $L_{Ey} = 1000 \text{ mm}$</p> <p>$L_x = 3000 \text{ mm}$, take $L_{Ex} = 3000 \text{ mm}$</p> <p>Conservatively, take $L_{ez} = L_x = 3000 \text{ mm}$</p> <p>$P_x = \frac{p^2 EI_x}{L_{Ex}^2} = \frac{p^2 \times 200,000 \times 20.5 \times 10^6 \times 10^{-3}}{3000^2} = 4496 \text{ kN}$ Eq. 4.10</p> <p>$P_y = \frac{p^2 EI_y}{L_{Ey}^2} = \frac{p^2 \times 200,000 \times 1.67 \times 10^6 \times 10^{-3}}{1000^2} = 3296 \text{ kN}$ Eq. 4.11</p> <p>$P_z = \frac{1}{r_0^2} \left[\frac{p^2 EH}{L_{Ez}^2} + GJ \right]$ Eq. 4.12</p> <p>$H = \frac{d_s^2 T_1 T_2 b_1^3 b_2^3}{12 (t_1 b_1^3 + t_2 b_2^3)} = \frac{190^2 \times 10^2 \times 100^6}{12 (10 \times 100^3) \times 2} = 1.50 \times 10^{10} \text{ mm}^6$ Eq. 4.16</p> <p>$r_0 = \sqrt{r_x^2 + r_y^2 + x_0^2} = \sqrt{84.08^2 + 23.98^2 + 0^2} = 87.43 \text{ mm}$ Eq. 4.15</p> <p>$P_z = \frac{1}{87.43^2} \left[\frac{p^2 \times 200,000 \times 1.5 \times 10^{10}}{3000^2} + 76,900 \times 74.2 \times 10^3 \right] = 1177 \text{ kN}$</p> <p>For failure by flexural buckling, P_E is the lower of P_x and P_y, thus $P_E = 3296 \text{ kN}$</p> <p>$\bar{I} = \sqrt{\frac{609}{3296}} = 0.430$ Eq. 4.9</p> <p>For flexural buckling of a welded open section subject to compression, Table 4.1</p> <p>$\alpha = 0.76$, $\bar{I}_0 = 0.2$</p> <p>Calculate reduction factor χ</p> <p>$f = 0.5 \left(1 + a(\bar{I} - \bar{I}_0) + (\bar{I})^2 \right) = 0.5 \left(1 + 0.76(0.430 - 0.2) + 0.430^2 \right)$ Table 4.1 Notes</p> <p>$= 0.680$</p> <p>$c = \frac{1}{f + (f^2 - \bar{I}^2)^{0.5}} = \frac{1}{0.68 + (0.68^2 - 0.43^2)^{0.5}} = 0.829$ Table 4.1 Notes</p> <p>For failure by torsional buckling: $P_E = P_z = 1177 \text{ kN}$</p>			

 <p>The Steel Construction Institute</p> <p>Silwood Park, Ascot, Berks SL5 7QN Telephone: (01344) 623345 Fax: (01344) 622944</p> <p>CALCULATION SHEET</p>	Job No. OSM459	Sheet 7 of 11	Rev
	Job Title Structural design of stainless steel		
	Subject Design example 3		
	Client SCI	Made by SMH	Date Aug 2001
	Checked by NRB	Date Aug 2001	
$\bar{I} = \sqrt{\frac{609}{1177}} = 0.719$ <p>Eq. 4.9</p> <p>For torsional buckling of a welded open section subject to compression,</p> $a = 0.34, \bar{I}_0 = 0.2$ <p>Table 4.1</p> <p>Calculate reduction factor χ</p> $f = 0.5 \left(1 + a(\bar{I} - \bar{I}_0) + (\bar{I})^2 \right) = 0.5 \left(1 + 0.34(0.719 - 0.2) + 0.719^2 \right) = 0.847$ $c = \frac{1}{f + (f^2 - \bar{I}^2)^{0.5}} = \frac{1}{0.847 + (0.847^2 - 0.719^2)^{0.5}} = 0.772$ <p>Since $0.772 < 0.829$, failure mode is torsional buckling and failure load is:</p> $P_c = 0.772 \times 2900 \times 210 = 470 \text{ kN}$ <p>Eq. 4.8</p> <p>Design compressive force $F_c = 16 \text{ kN}$, thus buckling resistance of the member is OK .</p> <p>Axial compression and bending resistance Section 4.5.2</p> <p>Local capacity interaction check:</p> $\frac{F_c}{A_g p_y} + \frac{M_x}{M_{cx}} + \frac{M_y}{M_{cy}} \leq 1$ <p>Eq. 4.61</p> $F_c = 16 \text{ kN}$ $M_x = 35.5 \text{ kNm} \quad M_y = 0$ $M_{cx} = 48.4 \text{ kNm}$ $\therefore \frac{16}{609} + \frac{35.5}{48.4} = 0.026 + 0.733 = 0.759 \leq 1.00$ <p>Local capacity of cross-section is OK</p> <p>Buckling resistance interaction check:</p> <p>For Class 1,2 or 3 sections</p> $\frac{F_c}{P_c} + \frac{m_x M_x}{p_y Z_x} + \frac{m_y M_y}{p_y Z_y} \leq 1$ <p>Eq. 4.63</p> $m_x = 0.95$			

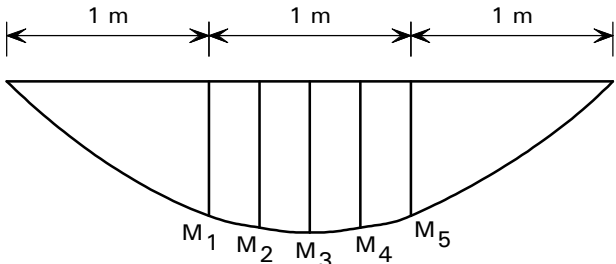
 <p>The Steel Construction Institute</p> <p>Silwood Park, Ascot, Berks SL5 7QN Telephone: (01344) 623345 Fax: (01344) 622944</p> <p>CALCULATION SHEET</p>	Job No. OSM459	Sheet 8 of 11	Rev
	Job Title Structural design of stainless steel		
	Subject Design example 3		
	Client SCI	Made by SMH	Date Aug 2001
	Checked by NRB	Date Aug 2001	
$\frac{16}{470} + \frac{0.95 \times 35.5 \times 10^6}{210 \times 20.5 \times 10^4} = 0.034 + 0.783 = 0.817 \leq 1.00 \quad \therefore \text{OK}$			BS 5950-1 Table 26
$\frac{F_c}{P_{c1}} + \frac{m_{LT} M_{LT}}{M_b} + \frac{m_y M_y}{p_y Z_y} \leq 1$			Eq. 4.64
<p>Calculate m_{LT}</p> 			
<p>The centre segment will be critical for lateral torsional buckling.</p> <p>From bending moment diagram,</p> $M_1 = M_5 = 26.27 \text{ kNm}$ $M_2 = M_4 = 31.23 \text{ kNm}$ $M_3 = M_{\max} = 35.50 \text{ kNm}$			
$m_{LT} = 0.2 + \frac{0.15 M_2 + 0.5 M_3 + 0.15 M_4}{M_{\max}}$			BS 5950-1 Table 18
$m_{LT} = 0.2 + \frac{0.15 \times 31.23 + 0.5 \times 35.5 + 0.15 \times 31.23}{35.5}$			
$m_{LT} = 0.964$			
$M_b = M_{cx} = 48.4 \text{ kNm}$			
$\frac{16}{470} + \frac{0.964 \times 35.5}{48.4} = 0.034 + 0.707 = 0.741 < 1.00$			
<p>\therefore Member is OK for combined axial compression and bending</p>			

 <p>The Steel Construction Institute</p> <p>Silwood Park, Ascot, Berks SL5 7QN Telephone: (01344) 623345 Fax: (01344) 622944</p> <p>CALCULATION SHEET</p>	Job No. OSM459	Sheet 9 of 11	Rev
	Job Title Structural design of stainless steel		
	Subject Design example 3		
	Client SCI	Made by SMH	Date Aug 2001
	Checked by NRB	Date Aug 2001	
<p>Web bearing, crippling and buckling at the end support</p> <p>Although this check is unlikely to be critical, it is included here to demonstrate the application of the guidance.</p> <p>The force is applied through one flange close to an unstiffened end.</p> <p>Thus $k_F = 2 + 6 \left[\frac{b_1 + b_e}{d} \right] \leq 6$</p> <p>Assume that the stiff bearing length $b_1 = 40$ mm and the distance to the nearer end of the member from the end of the stiff bearing $b_e = 50$ mm</p> $k_F = 2 + 6 \left[\frac{40 + 50}{180} \right] = 5$ $F_x \leq p_{yw} L_{eff} t$ <p>Calculate effective loaded length, l_y</p> $F_{cr} = 0.9 k_F E \frac{t^3}{d} = 0.9 \times 5 \times 200,000 \times \frac{5^3}{180} = 625 \text{ kN}$ $m_1 = \frac{p_{yf} (2b + t)}{p_{yw} t} = \frac{210 (2 \times 47.5 + 5)}{210 \times 5} = 20$ <p>Assume $I_F > 0.5$ and so $m_2 = 0.02 \left(\frac{d}{T} \right)^2 = 0.02 \left(\frac{180}{10} \right)^2 = 6.48$</p> $l_e = \frac{k_F E t^2}{2 p_{yw} d} \leq b_1 + b_e$ $\frac{k_F E t^2}{2 p_{yw} d} = \frac{5 \times 200,000 \times 5^2}{2 \times 210 \times 180} = 331 \text{ mm}$ $b_1 + b_e = 40 + 50 = 90 \text{ mm}$ $\therefore l_e = 90 \text{ mm}$ <p>At the end support (type c), l_y is given by the smallest of the following expressions:</p> $l_y = b_1 + 2T \left[1 + \sqrt{m_1 + m_2} \right] = 40 + 20 \left[1 + \sqrt{20 + 6.48} \right] = 162.9 \text{ mm}$			<p>Section 4.4.6</p> <p>Figure 4.4 Type c</p> <p>Eq. 4.42</p> <p>Eq. 4.52</p> <p>Eq. 4.43</p> <p>Eq. 4.44</p> <p>Eq. 4.48</p> <p>Eq. 4.45</p>

 <p>The Steel Construction Institute Silwood Park, Ascot, Berks SL5 7QN Telephone: (01344) 623345 Fax: (01344) 622944</p> <p>CALCULATION SHEET</p>	Job No. OSM459	Sheet 10 of 11	Rev
	Job Title Structural design of stainless steel		
	Subject Design example 3		
	Client SCI	Made by SMH	Date Aug 2001
	Checked by NRB	Date Aug 2001	
$l_y = l_e + T \left[\sqrt{\frac{m_1}{2} + \left(\frac{l_e}{T}\right)^2} + m_2 \right] = 90 + 10 \left[\sqrt{\frac{20}{2} + \left(\frac{90}{10}\right)^2} + 6.48 \right] = 188.7 \text{ mm}$ <p style="text-align: right;">Eq. 4.46</p> $l_y = l_e + T \sqrt{m_1 + m_2} = 90 + 10 \sqrt{20 + 6.48} = 141.5 \text{ mm}$ <p style="text-align: right;">Eq. 4.47</p> <p>If $l_y = 141.5 \text{ mm}$, check $I_F > 0.5$,</p> $I_F = \sqrt{\frac{l_y t p_{yw}}{F_{cr}}} = \sqrt{\frac{141.5 \times 5 \times 210}{625000}} = 0.487$ <p style="text-align: right;">Eq. 4.51</p> <p>Since $I_F < 0.5$, recalculate l_y, this time assuming $m_2 = 0$</p> $l_y = b_1 + 2T \left[1 + \sqrt{m_1 + 0} \right] = 40 + 20 \left[1 + \sqrt{20 + 0} \right] = 149.4 \text{ mm}$ $l_y = l_e + T \left[\sqrt{\frac{m_1}{2} + \left(\frac{l_e}{T}\right)^2} + m_2 \right] = 90 + 10 \left[\sqrt{\frac{20}{2} + \left(\frac{90}{10}\right)^2} + 0 \right] = 185.4 \text{ mm}$ $l_y = l_e + T \sqrt{m_1 + m_2} = 90 + 10 \sqrt{20 + 0} = 134.7 \text{ mm}$ <p>If $l_y = 134.7 \text{ mm}$, check value of I_F,</p> $I_F = \sqrt{\frac{l_y t p_{yw}}{F_{cr}}} = \sqrt{\frac{134.7 \times 5 \times 210}{625000}} = 0.475$ <p>$\therefore l_y = 134.7 \text{ mm}$</p> <p>Calculate effective length of resistance, L_{eff}</p> $L_{eff} = c_F l_y$ <p style="text-align: right;">Eq. 4.49</p> $c_F = \frac{0.5}{I_F} \leq 1.0$ <p style="text-align: right;">Eq. 4.50</p> $c_F = \frac{0.5}{0.475} > 1.00 \therefore \text{Limit to } 1.00$ $L_{eff} = 134.7 \times 1.00 = 134.7 \text{ mm}$ $p_{yw} L_{eff} t = 134.7 \times 5 \times 210 = 141.4 \text{ kN}$ <p style="text-align: right;">Eq. 4.42</p> <p>Shear force at the end support, $F_x = 31.6 \text{ kN}$, therefore resistance of web to the transverse forces is adequate.</p>			

 <p>The Steel Construction Institute Silwood Park, Ascot, Berks SL5 7QN Telephone: (01344) 623345 Fax: (01344) 622944</p> <p>CALCULATION SHEET</p>	Job No. OSM459	Sheet 11 of 11	Rev
	Job Title Structural design of stainless steel		
	Subject Design example 3		
	Client SCI	Made by SMH	Date Aug 2001
	Checked by NRB	Date Aug 2001	
<p>Deflection</p> <p>To calculate deflections, the secant modulus E_s must be determined.</p> <p>Moment due to unfactored imposed loads $= \frac{20 \times 3}{4} + \frac{6 \times 3^2}{8} = 21.8 \text{ kNm}$</p> <p>$Z_x = 20.5 \times 10^4 \text{ mm}^2$</p> <p>Hence $f = 21.8 \times 10^6 / 20.5 \times 10^4 = 106.3 \text{ N/mm}^2$</p> <p>Stress in section due to axial force $= \frac{F}{A} = \frac{10 \times 10^3}{2900} = 3.4 \text{ N/mm}^2$</p> <p>$\therefore$ Stress in tension flange \approx stress in compression flange $\approx 106 \text{ N/mm}^2$</p> <p>Secant modulus, $E_s = \frac{E}{1 + k \left(\frac{f}{p_y} \right)^{n-1}}$</p> <p>For grade 1.4301, when the direction of rolling is not known, conservatively, use constants for longitudinal direction:</p> <p>$k = 1.9 \quad n = 6.5$</p> <p>$\Rightarrow E_s = \frac{200,000}{1 + 1.9 \left(\frac{106}{210} \right)^{5.5}} = 192,000 \text{ N/mm}^2$</p> <p>Deflection due to UDL $= \frac{5 w L^4}{384 E_s I_x}$</p> <p>Deflection due to point load $= \frac{P L^3}{48 E_s I_x}$</p> <p>$\therefore$ Overall deflection $= \frac{5 \times 6 \times 3^4 \times 10^{12}}{384 \times 192000 \times 20.5 \times 10^6} + \frac{20 \times 10^3 \times 3^3 \times 10^9}{48 \times 192000 \times 20.5 \times 10^6}$</p> <p>$= 1.61 + 2.86 = 4.47 \text{ mm}$</p> <p>$\frac{4.47}{3000} = \frac{\text{span}}{670} < \frac{\text{span}}{180} \quad \therefore$ deflection is acceptably small</p>			<p>Section 4.4.8</p> <p>Eq. 4.58</p> <p>Table 4.3</p>

 <p>The Steel Construction Institute</p> <p>Silwood Park, Ascot, Berks SL5 7QN Telephone: (01344) 623345 Fax: (01344) 622944</p> <p>CALCULATION SHEET</p>	Job No. OSM459	Sheet 1 of 6	Rev
	Job Title Structural design of stainless steel		
	Subject Design example 4		
	Client SCI	Made by SMH	Date Aug 2001
	Checked by NRB	Date Aug 2001	

DESIGN EXAMPLE 4: AXIALLY LOADED COLUMN IN FIRE

Design an unprotected rectangular hollow section in grade 1.4401 (316) stainless steel subject to axial load and bending moment for 30 minutes fire resistance.

The column length is 2.7 m and is subject to axial load from the end reaction of a floor beam at an eccentricity of 90 mm from the narrow face of the column. The loads are:

Dead Load: 6 kN

Permanent Imposed Load: 7 kN (Note: NO temporary imposed loads)

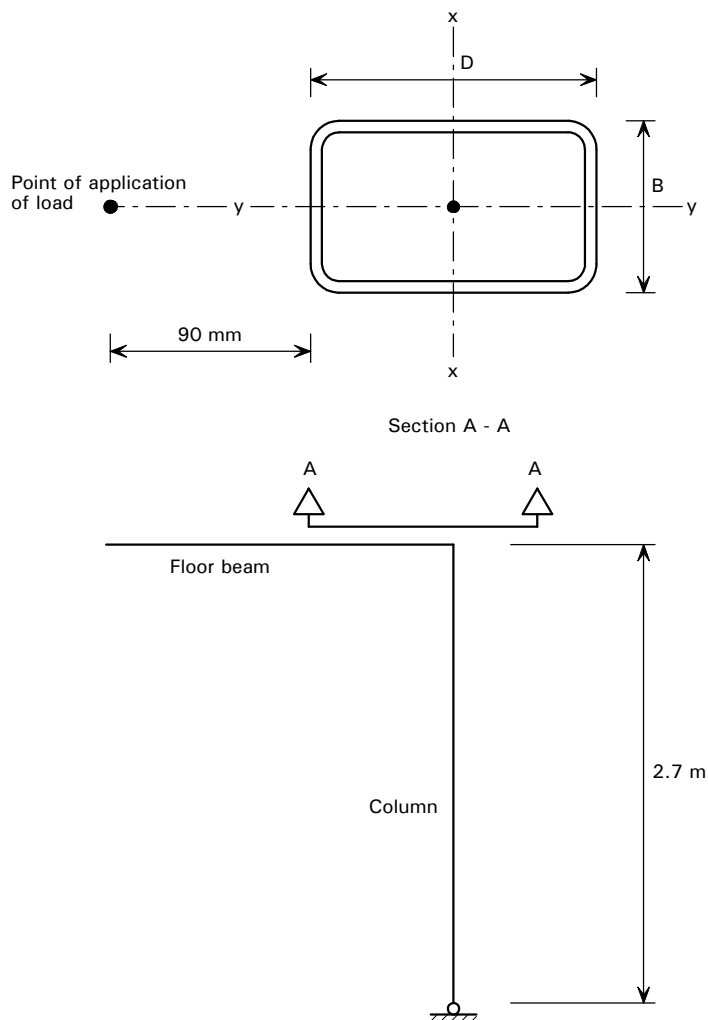

The column will initially be checked at the ultimate limit state (LC1) and subsequently at the fire limit state (LC2) for a fire duration of 30 minutes. The loadcases are as follow:

$$LC1 = 1.4 \times \text{Dead Load} + 1.6 \times \text{Imposed Load}$$

$$LC2 = 1.0 \times \text{Dead Load} + 1.0 \times \text{Permanent Imposed Load}$$

BS 5950-1
Table 2

Table 6.1

 <p>The Steel Construction Institute Silwood Park, Ascot, Berks SL5 7QN Telephone: (01344) 623345 Fax: (01344) 622944</p> <p>CALCULATION SHEET</p>	Job No. OSM459	Sheet 2 of 6	Rev
	Job Title Structural design of stainless steel		
	Subject Design example 4		
	Client SCI	Made by SMH	Date Aug 2001
	Checked by NRB	Date Aug 2001	
<p>For grade 1.4401 (316), 0.2% proof stress = 220 N/mm² and $U_s = 520$ N/mm² Take p_y as the 0.2% proof stress i.e. $p_y = 220$ N/mm² $E = 200,000$ N/mm²</p> <p>Design at the Ultimate Limit State (LC1) Axial Load $F_c = 1.4 \times 6 + 1.6 \times 7 = 19.6$ kN Try using a 100 × 50 × 6 rectangular hollow section Design moment $M_x = 19.6 \times (90 + 100/2) = 2.74$ kNm</p> <p>Section properties $S_x = 43.75$ cm³ $r_x = 3.29$ cm $Z_x = 32.58$ cm³ $r_y = 1.91$ cm $A_g = 15$ cm² Assuming an internal radius of $2t$, $d = 64$ mm and $b = 14$ mm</p> <p>Classification of cross-section $e = 1.10$ Assume worst case - webs in compression $\frac{d}{t} = \frac{64}{6} = 10.67 < 28e = 30.8 \therefore$ Web is at least Class 3 Check for actual case of combined bending and compression: $r_1 = \frac{F_c}{2 d t p_{yw}}$ for RHS $r_1 = \frac{19.6 \times 10^3}{2 \times 64 \times 6 \times 220} = 0.116$ $\frac{52\varepsilon}{r_1 + 1} = 51.25 > 10.67 \therefore$ Web is Class 1 Check flange in compression $\frac{b}{t} = \frac{14}{6} = 2.33 < 23e = 25.3 \therefore$ Flange is Class 1 \therefore Classification of cross-section: Class 1</p>			<p>Table 2.2</p> <p>Table 2.4</p> <p>Design Table 2</p> <p>Table 3.1</p> <p>Table 3.1</p> <p>Table 3.1</p> <p>Eq. 3.8</p>

 <p>The Steel Construction Institute Silwood Park, Ascot, Berks SL5 7QN Telephone: (01344) 623345 Fax: (01344) 622944</p> <p>CALCULATION SHEET</p>	Job No. OSM459	Sheet 3 of 6	Rev
	Job Title Structural design of stainless steel		
	Subject Design example 4		
	Client SCI	Made by SMH	Date Aug 2001
	Checked by NRB	Date Aug 2001	
<p>Axial compression and bending resistance</p> <p>Local capacity interaction check:</p> $\frac{F_c}{A_g p_y} + \frac{M_x}{M_{cx}} + \frac{M_y}{M_{cy}} \leq 1$ $A_g p_y = 1500 \times 220 = 330 \text{ kN}$ $M_y = 0$ $M_{cx} = S_x p_y \quad \text{but not more than } 1.5 Z_x p_y$ $S_x p_y = 43.75 \times 10^3 \times 220 = 9.625 \text{ kNm}$ $1.5 Z_x p_y = 1.5 \times 32.58 \times 10^3 \times 220 = 10.75 \text{ kNm}$ $\therefore M_{cx} = 9.625 \text{ kNm}$ $\frac{F_c}{A_g p_y} + \frac{M_x}{M_{cx}} = \frac{19.6}{330} + \frac{2.74}{9.625} = 0.0594 + 0.285 = 0.344 < 1.00$ <p>Local capacity of cross-section is OK</p> <p>Buckling resistance interaction check:</p> $\frac{F_c}{P_c} + \frac{m_x M_x}{p_y Z_x} + \frac{m_y M_y}{p_y Z_y} \leq 1$ <p>It is assumed that the effective length of the column is equal to the actual column length. Thus $L_E = 2.7\text{m}$</p> <p>From Design Table 40,</p> $P_c = 123 \text{ kN for } L_E = 2.5 \text{ m}$ $P_c = 91.6 \text{ kN for } L_E = 3.0 \text{ m}$ <p>By linear interpolation, for $L_E = 2.7 \text{ m}$, $P_c = 110.4 \text{ kN}$</p> <p>Assuming the column is pinned at the base, a triangular bending moment distribution occurs.</p> $m_x = 0.6 \text{ for a triangular bending moment distribution}$ $\frac{F_c}{P_c} + \frac{m_x M_x}{p_y Z_x} = \frac{19.6}{110.4} + \frac{0.6 \times 2.74 \times 10^6}{32.58 \times 10^3 \times 220} = 0.178 + 0.229 = 0.407 < 1.00$ <p>Thus the member is OK for combined axial compression and bending under LC1.</p> <p>By inspection, the check using Eq 4.65 will not be critical as $m_{LT} = m_x = 0.6$</p>			<p>Section 4.5.2</p> <p>Eq. 4.61</p> <p>Section 4.4.2</p> <p>Eq. 4.63</p> <p>Design Table 40</p> <p>BS 5950-1 Table 26</p>

 <p>The Steel Construction Institute Silwood Park, Ascot, Berks SL5 7QN Telephone: (01344) 623345 Fax: (01344) 622944</p> <p>CALCULATION SHEET</p>	Job No. OSM459	Sheet 4 of 6	Rev
	Job Title Structural design of stainless steel		
	Subject Design example 4		
	Client SCI	Made by SMH	Date Aug 2001
	Checked by NRB	Date Aug 2001	
<p>Design at the Fire Limit State (LC2)</p> <p>For LC2, the column is designed for the following axial loads and moments.</p> <p>Factored loads: Dead Load = $1.0 \times 6 = 6.0\text{kN}$ Permanent Imposed Load = $1.0 \times 7 = 7.0\text{ kN}$</p> <p>Axial compressive load $F_{c,fi} = 6.0 + 7.0 = 13.0\text{ kN}$</p> <p>Maximum bending moment, $M_{x,fi} = 13.0 \times (90+100/2) \times 10^{-3} = 1.82\text{ kNm}$</p> <p>Determine temperature of steel after 30 minutes fire duration</p> <p>Assume that the section is unprotected and that there is a uniform temperature distribution within the steel section. Increase in temperature during time interval Dt is found from:</p> $Dq_s = \frac{a_c + a_r}{c_s r_s} \frac{H_p}{A_g} (q_f - q_s) Dt$ <p>Eq. 6.25</p> <p>Assume temperature-time relationship is given by the standard temperature time curve:</p> $q_f = 20 + 345 \log_{10}(8t + 1)$ <p>Eq. 6.27</p> <p>Initial input values for determination of steel temperature are as follows:</p> $H_p = 2D + 2B = 300\text{ mm}$ $H_p/A = 200\text{ m}^{-1}$ $a_c = 25\text{ W/m}^2\text{ }^\circ\text{C}$ <p>Initial steel temperature $q = 20^\circ\text{C}$</p> <p>Resultant emissivity $e = 0.4$</p> <p>Density of stainless steel $r_s = 8000\text{ kg/m}^3$</p> <p>Table 2.4</p> <p>The specific heat is temperature dependent and is given by the following expression:</p> $c_s = 450 + 0.280 \times q - 2.91 \times 10^{-4} q^2 + 1.34 \times 10^{-7} q^3\text{ J/kg}^\circ\text{C}$ <p>Eq. 6.4</p> <p>A time interval of two seconds is used.</p> <p>The above formulae and initial input information were coded in an Excel spreadsheet and the following steel temperature, after a fire duration of 30 minutes, was obtained:</p> $q_s = 829^\circ\text{C}$			

 <p>The Steel Construction Institute</p> <p>Silwood Park, Ascot, Berks SL5 7QN Telephone: (01344) 623345 Fax: (01344) 622944</p> <p>CALCULATION SHEET</p>	Job No. OSM459	Sheet 5 of 6	Rev
	Job Title Structural design of stainless steel		
	Subject Design example 4		
	Client SCI	Made by SMH	Date Aug 2001
	Checked by NRB	Date Aug 2001	
<p>Reduction of mechanical properties at elevated temperatures</p> <p>The following reduction factors are required for calculation of resistance at elevated temperatures.</p> <p>Young's modulus retention factor $k_{E,\theta} = E_{\theta}/E$</p> <p>0.2% proof strength retention factor $k_{p0.2\text{proof},\theta} = p_{0.2\text{proof},\theta}/p_y$</p> <p>Ultimate tensile strength retention factor $k_{U,\theta} = U_{s,\theta}/U_s$</p> <p>The value of the 2% yield strength at elevated temperature is also required for capacity calculations. This is given by the following expression:</p> $p_{2,\theta} = p_{0.2\text{proof},\theta} + g_{2,\theta} (U_{s,\theta} - p_{0.2\text{proof},\theta})$ <p>The values for the retention factor at 829°C are obtained by linear interpolation.</p> $k_{p0.2\text{proof},\theta} = 0.339$ $k_{U,\theta} = 0.294$ $k_{E,\theta} = 0.578$ $g_{2,\theta} = 0.359$ <p>Hence $p_{2,\theta} = 0.339 \times 220 + 0.359 \times (0.294 \times 520 - 0.339 \times 220)$ $= 102.7 \text{ N/mm}^2$</p> <p>And thus $k_{p2,\theta} = 102.7/220 = 0.467$</p> <p>Member buckling due to compression</p> $P_{c,\theta} = c_{\theta} A_g k_{p2,\theta} p_y$ $\bar{\lambda}_{\theta} = \bar{\lambda} [k_{p2,\theta} / k_{E,\theta}]^{0.5}$ $\bar{\lambda} = \sqrt{\frac{P_{sq}}{P_c}} = \sqrt{\frac{330}{110.4}} = 1.729$ $\bar{\lambda}_{\theta} = 1.729 \times (0.467/0.578)^{0.5} = 1.554$ <p>For grade 1.4401 (316), by linear interpolation of the values in Table 6.3 for $\bar{\lambda}_q = 1.554$, by linear interpolation, $c_{\theta} = 0.262$</p> $P_{c,\theta} = 0.262 \times 1500 \times 0.467 \times 220$ $= 40.38 \text{ kN}$ $F_{c,fi} = 13.0 \text{ kN, therefore, section is OK}$			<p>Section 6.2</p> <p>Eq. 6.1</p> <p>Table 6.2</p> <p>Section 6.4.3</p> <p>Eq. 6.8</p> <p>Eq. 6.10</p> <p>Table 6.3</p>

 <p>The Steel Construction Institute</p> <p>Silwood Park, Ascot, Berks SL5 7QN Telephone: (01344) 623345 Fax: (01344) 622944</p> <p>CALCULATION SHEET</p>	Job No. OSM459	Sheet 6 of 6	Rev
	Job Title Structural design of stainless steel		
	Subject Design example 4		
	Client SCI	Made by SMH	Date Aug 2001
	Checked by NRB	Date Aug 2001	
<p>Axial compression and bending resistance</p> <p>For a class 1 cross section, the following expression must be satisfied</p> $\frac{F_{c,fi}}{c_{min,\theta} A_g k_{p2,\theta} p_y} + \frac{k_x M_{x,fi}}{k_{p2,\theta} M_{cx,\theta}} + \frac{k_y M_{y,fi}}{k_{p2,\theta} M_{cy,\theta}} \leq 1$ $k_x = 1 - \frac{m_x F_{c,fi}}{c_{x,\theta} A_g k_{p2,\theta} p_y} \leq 3$ $m_x = (1.2 b_{M,x} - 3) \bar{I}_{x,\theta} + 0.44 b_{M,x} - 0.29 \leq 0.8$ <p>Assuming, as previously, a triangular moment distribution, $b_M = 1.8$ and using previously obtained values for $\bar{I}_\theta = 1.554$ and $c_\theta = 0.262$, m_x is calculated as follows:</p> $m_x = (1.2 \times 1.8 - 3) \times 1.554 + 0.44 \times 1.8 - 0.29 = -0.803$ $k_x = 1 - \frac{-0.803 \times 13 \times 10^3}{0.262 \times 1500 \times 220 \times 0.467} = 1.259$ <p>Hence, the LHS is</p> $\frac{F_{c,fi}}{c_{min,\theta} A_g k_{p2,\theta} p_y} + \frac{k_x M_{x,fi}}{k_{p2,\theta} M_{cx,\theta}}$ $= \frac{13 \times 10^3}{0.262 \times 1500 \times 220 \times 0.467} + \frac{1.259 \times 1.82 \times 10^6}{43.75 \times 10^3 \times 0.467 \times 220}$ $= 0.322 + 0.510 = 0.832 < 1.00$ <p>Therefore section can support the loading after exposure in a fire for 30 minutes.</p>			Section 6.4.6
			Eq. 6.21
			Table 6.4

DESIGN TABLES

This Section presents a total of 80 design tables for:

- dimensions and gross section properties
- section classification and effective section properties
- member capacities.

The tables cover cold formed stainless steel sections for use as structural members for both onshore and offshore construction.

The tables are grouped in six sections, each printed on different tinted paper:

	Colour
• Dimensions and gross section properties	Cream
• Section classification and effective section properties	Blue
• Member capacities – Grade 1.4301 (304)	Pink
• Member capacities – Grade 1.4401 (316) and 1.4404 (316L)	Green
• Member capacities – Grade 1.4362 (SAF 2304)	Yellow
• Member capacities – Grade 1.4462 (2205)	Grey

Index to design tables

Tables of dimension and gross section properties

Table Number		Page Number Cream pages
1	Circular hollow sections	A-2
2	Rectangular hollow sections	A-5
3	Square hollow sections	A-8
4	Channels	A-10
5	Double channels back to back	A-12
6	Equal angles	A-14
7	Double angles back to back	A-15

Tables of section classification and effective section properties

Table Number		Page Number Blue pages
8	Circular hollow sections subject to compression	B-2
9	Rectangular hollow sections subject to compression	B-3
10	Square hollow sections subject to compression	B-6
11	Channels subject to compression	B-8
12	Double channels back to back subject to compression	B-10
13	Equal angles subject to compression	B-12
14	Double angles back to back subject to compression	B-13
15	Circular hollow sections subject to pure bending axis x-x	B-14
16	Rectangular hollow sections subject to pure bending axis x-x	B-15
17	Square hollow sections subject to pure bending axis x-x	B-16
18	Channels subject to pure bending axis x-x	B-18
19	Double channels back to back subject to pure bending axis x-x	B-20
20	Equal angles subject to pure bending axis x-x	B-22
21	Rectangular hollow sections subject to pure bending axis y-y	B-23
22	Channels subject to pure bending axis y-y	B-26
23	Double channels back to back subject to pure bending axis y-y	B-29
24	Double angles subject to pure bending axis y-y	B-31

Member capacity tables

Table Numbers		Page Numbers Pink, Green, Yellow, Grey
Subject to axial compression:		
25,39,53,67	Circular hollow sections	C,D,E,F-2
26,40,54,68	Rectangular hollow sections	C,D,E,F-4
27,41,55,69	Square hollow sections	C,D,E,F-8
28,42,56,70	Channels	C,D,E,F-10
29,43,57,71	Double channels back to back	C,D,E,F-13
30,44,58,72	Equal angles	C,D,E,F-16
31,45,59,73	Double angles back to back	C,D,E,F-18
Subject to axial tension:		
32,46,60,74	Equal angles	C,D,E,F-20
33,47,61,75	Double angles back to back	C,D,E,F-22
Subject to bending:		
34,48,62,76	Circular hollow sections	C,D,E,F-24
35,49,63,77	Rectangular hollow sections	C,D,E,F-26
36,50,64,78	Square hollow sections	C,D,E,F-28
37,51,65,79	Channels	C,D,E,F-30
38,52,66,80	Double channels back to back	C,D,E,F-31

A. DIMENSIONS & GROSS SECTION PROPERTIES

Table 1 CIRCULAR HOLLOW SECTIONS

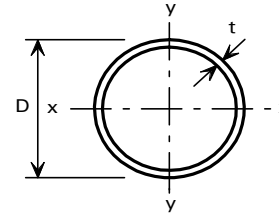

DIMENSIONS & GROSS SECTION PROPERTIES

D	t	Area	Mass	I_x, I_y	r_x, r_y	Z_x, Z_y	S_x, S_y	J	C
mm	mm	cm ²	kg/m	cm ⁴	cm	cm ³	cm ³	cm ⁴	cm ³
21.3	1.0	0.64	0.50	0.3293	0.719	0.3092	0.4124	0.6586	0.6184
21.3	1.2	0.76	0.60	0.3840	0.712	0.3606	0.4854	0.7681	0.7212
21.3	1.6	0.99	0.78	0.4835	0.699	0.4540	0.6223	0.9671	0.9081
21.3	2.0	1.21	0.96	0.5707	0.686	0.5359	0.7476	1.141	1.072
21.3	2.3	1.37	1.08	0.6286	0.677	0.5902	0.8344	1.257	1.180
33.7	1.0	1.03	0.81	1.374	1.16	0.8157	1.070	2.749	1.631
33.7	1.6	1.61	1.27	2.083	1.14	1.236	1.650	4.167	2.473
33.7	2.0	1.99	1.57	2.512	1.12	1.491	2.012	5.024	2.981
33.7	2.5	2.45	1.94	3.001	1.11	1.781	2.439	6.002	3.562
33.7	3.2	3.07	2.42	3.605	1.08	2.139	2.988	7.209	4.279
42.4	1.0	1.30	1.03	2.788	1.46	1.315	1.714	5.576	2.630
42.4	1.6	2.05	1.62	4.274	1.44	2.016	2.665	8.548	4.032
42.4	2.0	2.54	2.01	5.192	1.43	2.449	3.267	10.38	4.898
42.4	2.6	3.25	2.57	6.464	1.41	3.049	4.124	12.93	6.099
42.4	3.2	3.94	3.11	7.620	1.39	3.594	4.928	15.24	7.189
48.3	1.0	1.49	1.17	4.158	1.67	1.722	2.238	8.315	3.443
48.3	1.6	2.35	1.85	6.407	1.65	2.653	3.491	12.81	5.306
48.3	2.0	2.91	2.30	7.810	1.64	3.234	4.290	15.62	6.468
48.3	2.6	3.73	2.95	9.777	1.62	4.048	5.436	19.55	8.097
48.3	3.2	4.53	3.58	11.59	1.60	4.797	6.520	23.17	9.595
60.3	1.0	1.86	1.47	8.191	2.10	2.717	3.517	16.38	5.434
60.3	1.6	2.95	2.33	12.72	2.08	4.218	5.514	25.44	8.436
60.3	2.0	3.66	2.89	15.58	2.06	5.168	6.800	31.16	10.34
60.3	2.6	4.71	3.72	19.65	2.04	6.519	8.662	39.31	13.04
60.3	3.2	5.74	4.53	23.47	2.02	7.784	10.44	46.94	15.57
60.3	4.0	7.07	5.59	28.17	2.00	9.344	12.70	56.35	18.69
60.3	5.0	8.69	6.86	33.48	1.96	11.10	15.33	66.95	22.21
76.1	1.0	2.36	1.86	16.64	2.66	4.372	5.640	33.27	8.744
76.1	1.6	3.74	2.96	25.99	2.63	6.831	8.882	51.99	13.66
76.1	2.0	4.66	3.68	31.98	2.62	8.404	10.98	63.96	16.81
76.1	2.6	6.00	4.74	40.59	2.60	10.67	14.05	81.18	21.34

For explanation of table see Section 8.2.

Table 1 CIRCULAR HOLLOW SECTIONS

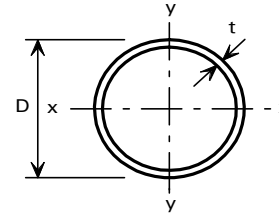

DIMENSIONS & GROSS SECTION PROPERTIES

D	t	Area	Mass	I_x, I_y	r_x, r_y	Z_x, Z_y	S_x, S_y	J	C
mm	mm	cm ²	kg/m	cm ⁴	cm	cm ³	cm ³	cm ⁴	cm ³
76.1	3.2	7.33	5.79	48.78	2.58	12.82	17.02	97.56	25.64
76.1	4.0	9.06	7.16	59.06	2.55	15.52	20.81	118.1	31.04
76.1	5.0	11.2	8.82	70.92	2.52	18.64	25.32	141.8	37.28
88.9	1.0	2.76	2.18	26.67	3.11	6.001	7.727	53.35	12.00
88.9	1.6	4.39	3.47	41.82	3.09	9.408	12.20	83.64	18.82
88.9	2.0	5.46	4.31	51.57	3.07	11.60	15.11	103.1	23.20
88.9	2.6	7.05	5.57	65.68	3.05	14.78	19.37	131.4	29.55
88.9	3.2	8.62	6.81	79.21	3.03	17.82	23.51	158.4	35.64
88.9	4.0	10.7	8.43	96.34	3.00	21.67	28.85	192.7	43.35
88.9	5.0	13.2	10.4	116.4	2.97	26.18	35.24	232.7	52.36
101.6	1.0	3.16	2.50	39.98	3.56	7.871	10.12	79.97	15.74
101.6	1.6	5.03	3.97	62.85	3.54	12.37	16.00	125.7	24.74
101.6	2.0	6.26	4.94	77.63	3.52	15.28	19.84	155.3	30.56
101.6	2.6	8.09	6.39	99.14	3.50	19.52	25.49	198.3	39.03
101.6	3.2	9.89	7.81	119.9	3.48	23.59	31.00	239.7	47.19
101.6	4.0	12.3	9.69	146.3	3.45	28.80	38.12	292.6	57.59
101.6	5.0	15.2	12.0	177.5	3.42	34.93	46.70	354.9	69.87
114.3	1.2	4.26	3.37	68.18	4.00	11.93	15.35	136.4	23.86
114.3	1.6	5.66	4.48	89.96	3.98	15.74	20.32	179.9	31.48
114.3	2.0	7.06	5.57	111.3	3.97	19.47	25.23	222.5	38.94
114.3	2.6	9.12	7.21	142.4	3.95	24.91	32.45	284.7	49.82
114.3	3.2	11.2	8.82	172.5	3.93	30.18	39.51	344.9	60.36
114.3	4.0	13.9	10.9	211.1	3.90	36.93	48.69	422.1	73.86
114.3	5.0	17.2	13.6	256.9	3.87	44.96	59.77	513.8	89.91
139.7	1.2	5.22	4.12	125.2	4.90	17.92	23.02	250.4	35.85
139.7	1.6	6.94	5.48	165.5	4.88	23.69	30.52	331.0	47.39
139.7	2.0	8.65	6.84	205.1	4.87	29.36	37.93	410.2	58.73
139.7	2.6	11.2	8.85	263.2	4.85	37.68	48.88	526.4	75.36
139.7	3.2	13.7	10.8	319.8	4.83	45.78	59.63	639.6	91.56
139.7	4.0	17.1	13.5	392.9	4.80	56.24	73.68	785.7	112.5
139.7	5.0	21.2	16.7	480.5	4.77	68.80	90.76	961.1	137.6

For explanation of table see Section 8.2.

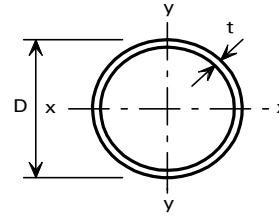
Table 1 CIRCULAR HOLLOW SECTIONS**DIMENSIONS & GROSS SECTION PROPERTIES**

D mm	t mm	Area cm ²	Mass kg/m	I_x, I_y cm ⁴	r_x, r_y cm	Z_x, Z_y cm ³	S_x, S_y cm ³	J cm ⁴	C cm ³
168.3	1.6	8.38	6.62	291.1	5.89	34.59	44.46	582.2	69.18
168.3	2.0	10.4	8.25	361.3	5.88	42.93	55.31	722.5	85.86
168.3	2.6	13.5	10.7	464.6	5.86	55.21	71.39	929.3	110.4
168.3	3.2	16.6	13.1	565.7	5.84	67.23	87.24	1131	134.5
168.3	4.0	20.6	16.3	697.1	5.81	82.84	108.0	1394	165.7
168.3	5.0	25.7	20.3	855.8	5.78	101.7	133.4	1711	203.4
219.1	2.0	13.6	10.8	803.7	7.68	73.37	94.27	1607	146.7
219.1	2.6	17.7	14.0	1036	7.65	94.59	121.9	2072	189.2
219.1	3.2	21.7	17.1	1264	7.63	115.5	149.2	2529	230.9
219.1	4.0	27.0	21.4	1563	7.61	142.8	185.1	3127	285.5
219.1	5.0	33.6	26.6	1928	7.57	176.0	229.2	3856	352.0
273	2.6	22.1	17.4	2018	9.56	147.9	190.1	4037	295.8
273	3.2	27.1	21.4	2468	9.54	180.8	232.9	4936	361.7
273	4.0	33.8	26.7	3058	9.51	224.0	289.5	6116	448.1
273	5.0	42.1	33.3	3780	9.48	277.0	359.2	7561	554.0

For explanation of table see Section 8.2.

Table 2 RECTANGULAR HOLLOW SECTIONS

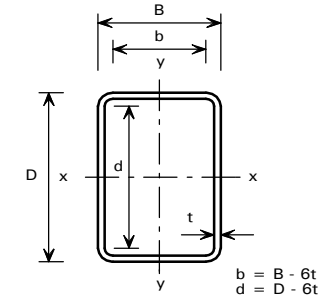

DIMENSIONS & GROSS SECTION PROPERTIES

D x B mm	t mm	d mm	Area cm ²	Mass kg/m	I _x cm ⁴	I _y cm ⁴	r _x cm	r _y cm	Z _x cm ³	Z _y cm ³	S _x cm ³	S _y cm ³	J cm ⁴	C cm ³
50 x 25	1.5	41	2.06	1.63	6.408	2.192	1.76	1.03	2.563	1.753	3.235	2.005	5.562	3.108
50 x 25	2.0	38	2.67	2.11	7.946	2.699	1.73	1.01	3.178	2.159	4.088	2.528	7.063	3.875
60 x 30	2.0	48	3.27	2.58	14.42	4.919	2.10	1.23	4.806	3.280	6.103	3.780	12.62	5.837
60 x 30	3.0	42	4.65	3.68	19.08	6.441	2.02	1.18	6.360	4.294	8.351	5.150	17.33	7.800
80 x 40	2.0	68	4.47	3.53	36.24	12.44	2.85	1.67	9.061	6.220	11.33	7.034	31.06	10.96
80 x 40	3.0	62	6.45	5.10	49.73	16.92	2.78	1.62	12.43	8.460	15.91	9.847	43.95	15.13
80 x 40	4.0	56	8.27	6.54	60.30	20.36	2.70	1.57	15.07	10.18	19.79	12.21	54.77	18.49
100 x 50	2.0	88	5.67	4.48	73.25	25.24	3.59	2.11	14.65	10.09	18.16	11.29	61.97	17.68
100 x 50	3.0	82	8.25	6.52	102.5	35.07	3.52	2.06	20.51	14.03	25.88	16.04	88.99	24.86
100 x 50	4.0	76	10.7	8.43	127.1	43.19	3.45	2.01	25.43	17.27	32.71	20.22	113.0	31.00
100 x 50	5.0	70	12.9	10.2	147.2	49.70	3.37	1.96	29.44	19.88	38.66	23.84	133.7	36.11
100 x 50	6.0	64	15.0	11.9	162.9	54.72	3.29	1.91	32.58	21.89	43.75	26.91	150.9	40.23
150 x 75	3.0	132	12.8	10.1	370.8	127.8	5.39	3.17	49.44	34.07	61.29	38.10	313.7	59.68
150 x 75	4.0	126	16.7	13.2	472.3	161.9	5.32	3.12	62.98	43.18	78.99	49.02	406.5	76.24
150 x 75	5.0	120	20.4	16.1	563.2	192.2	5.25	3.07	75.09	51.24	95.35	59.06	492.8	91.21
150 x 75	6.0	114	24.0	19.0	643.6	218.6	5.18	3.02	85.82	58.30	110.4	68.26	572.1	104.6
150 x 75	8.0	102	30.7	24.2	774.2	260.9	5.02	2.92	103.2	69.57	136.5	84.13	708.0	126.9
150 x 100	3.0	132	14.3	11.3	451.8	243.7	5.63	4.13	60.25	48.74	72.31	54.98	510.5	81.26
150 x 100	4.0	126	18.7	14.8	578.9	311.6	5.57	4.08	77.19	62.31	93.59	71.11	666.1	104.6
150 x 100	5.0	120	22.9	18.1	694.6	373.0	5.50	4.03	92.62	74.61	113.5	86.16	813.5	126.1
150 x 100	6.0	114	27.0	21.3	799.2	428.4	5.44	3.98	106.6	85.67	132.0	100.2	952.2	145.9
150 x 100	8.0	102	34.7	27.4	976.0	521.3	5.30	3.88	130.1	104.3	164.9	125.0	1201	180.2
200 x 100	4.0	176	22.7	17.9	1171	403.8	7.19	4.22	117.2	80.76	145.3	90.31	991.5	141.5
200 x 100	5.0	170	27.9	22.1	1415	486.0	7.12	4.17	141.6	97.19	177.0	109.9	1213	171.3
200 x 100	6.0	164	33.0	26.1	1640	561.1	7.05	4.12	164.1	112.2	207.0	128.4	1423	198.9
200 x 100	8.0	152	42.7	33.7	2034	691.0	6.90	4.02	203.4	138.2	261.7	161.8	1808	248.0
200 x 100	10.0	140	51.7	40.8	2355	795.2	6.75	3.92	235.5	159.0	309.3	190.7	2139	288.9
200 x 125	4.0	176	24.7	19.5	1364	666.0	7.44	5.20	136.4	106.6	164.9	119.9	1449	179.8
200 x 125	5.0	170	30.4	24.0	1653	805.7	7.37	5.15	165.3	128.9	201.4	146.4	1781	218.7
200 x 125	6.0	164	36.0	28.5	1922	935.1	7.31	5.10	192.3	149.6	236.1	171.5	2099	255.2
200 x 125	8.0	152	46.7	36.9	2403	1164	7.17	4.99	240.3	186.3	300.1	217.7	2692	321.3
200 x 125	10.0	140	56.7	44.8	2807	1355	7.04	4.89	280.7	216.9	356.8	258.5	3223	378.4

For explanation of table see Section 8.2.

Table 2 RECTANGULAR HOLLOW SECTIONS

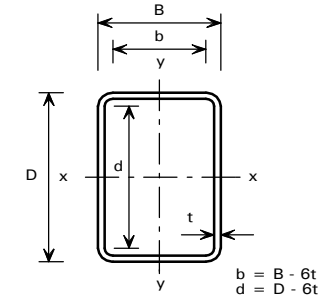

DIMENSIONS & GROSS SECTION PROPERTIES

D x B mm	t mm	d mm	Area cm ²	Mass kg/m	I _x cm ⁴	I _y cm ⁴	r _x cm	r _y cm	Z _x cm ³	Z _y cm ³	S _x cm ³	S _y cm ³	J cm ⁴	C cm ³
250 x 125	6.0	214	42.0	33.2	3341	1147	8.92	5.23	267.3	183.6	333.7	207.2	2856	323.2
250 x 125	8.0	202	54.7	43.2	4211	1438	8.78	5.13	336.9	230.2	426.8	264.5	3673	409.0
250 x 125	10.0	190	66.7	52.7	4966	1686	8.63	5.03	397.3	269.9	511.1	316.0	4414	484.3
250 x 125	12.0	178	78.1	61.7	5607	1895	8.48	4.93	448.6	303.3	586.6	361.9	5072	549.5
250 x 125	15.0	160	93.8	74.1	6364	2137	8.24	4.77	509.1	342.0	683.6	420.5	5894	628.5
250 x 150	6.0	214	45.0	35.6	3787	1732	9.17	6.20	303.0	231.1	370.3	261.6	3911	394.5
250 x 150	8.0	202	58.7	46.4	4797	2187	9.04	6.10	383.8	291.6	475.2	335.3	5060	502.3
250 x 150	10.0	190	71.7	56.6	5686	2583	8.91	6.00	454.9	344.5	571.1	402.5	6121	598.9
250 x 150	12.0	178	84.1	66.4	6457	2925	8.77	5.90	516.6	390.0	658.0	463.3	7088	684.4
250 x 150	15.0	160	101	80.1	7400	3339	8.55	5.74	592.1	445.3	771.7	542.5	8346	792.4
300 x 150	6.0	264	51.0	40.3	5932	2044	10.8	6.33	395.5	272.5	490.3	304.8	5019	477.4
300 x 150	8.0	252	66.7	52.7	7557	2590	10.6	6.23	503.8	345.4	631.9	392.1	6504	609.9
300 x 150	10.0	240	81.7	64.5	9010	3074	10.5	6.13	600.7	410.0	762.8	472.5	7884	729.6
300 x 150	12.0	228	96.1	75.9	10300	3498	10.4	6.03	686.5	466.4	883.1	546.1	9153	836.9
300 x 150	15.0	210	116	91.9	11920	4025	10.1	5.88	795.0	536.8	1043	643.8	10830	974.9
300 x 200	6.0	264	57.0	45.0	7229	3899	11.3	8.27	482.0	389.9	578.5	439.8	8167	650.1
300 x 200	8.0	252	74.7	59.0	9262	4985	11.1	8.17	617.5	498.5	748.7	568.9	10660	836.8
300 x 200	10.0	240	91.7	72.4	11110	5968	11.0	8.07	741.0	596.9	907.8	689.3	13020	1009
300 x 200	12.0	228	108	85.4	12790	6853	10.9	7.96	852.5	685.4	1055	801.2	15240	1167
300 x 200	15.0	210	131	103	14970	8003	10.7	7.81	998.2	800.3	1257	953.4	18290	1378
350 x 175	6.0	314	60.0	47.4	9603	3315	12.6	7.43	548.8	379.0	676.9	421.1	8062	661.7
350 x 175	8.0	302	78.7	62.2	12320	4235	12.5	7.34	704.0	484.1	877.1	544.8	10500	850.8
350 x 175	10.0	290	96.7	76.4	14800	5067	12.4	7.24	845.8	579.2	1064	660.3	12800	1024
350 x 175	12.0	278	114	90.1	17050	5814	12.2	7.14	974.5	664.6	1239	767.7	14960	1184
350 x 175	15.0	260	138	109	20010	6783	12.0	6.99	1143	775.3	1479	913.9	17900	1396
350 x 200	6.0	314	63.0	49.8	10490	4464	12.9	8.42	599.5	446.4	728.5	498.0	10130	763.0
350 x 200	8.0	302	82.7	65.3	13490	5722	12.8	8.32	770.9	572.3	945.5	645.7	13230	984.2
350 x 200	10.0	290	101	80.3	16250	6872	12.6	8.22	928.4	687.2	1149	784.3	16170	1189
350 x 200	12.0	278	120	94.8	18770	7915	12.5	8.12	1072	791.6	1341	914.0	18960	1379
350 x 200	15.0	260	146	115	22110	9289	12.3	7.97	1263	928.9	1604	1092	22820	1634

For explanation of table see Section 8.2.

Table 2 RECTANGULAR HOLLOW SECTIONS

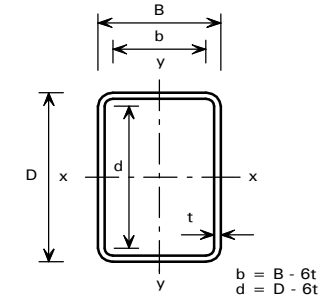

DIMENSIONS & GROSS SECTION PROPERTIES

D x B mm	t mm	d mm	Area cm ²	Mass kg/m	I _x cm ⁴	I _y cm ⁴	r _x cm	r _y cm	Z _x cm ³	Z _y cm ³	S _x cm ³	S _y cm ³	J cm ⁴	C cm ³
400 x 200	6.0	364	69.0	54.5	14540	5028	14.5	8.54	727.0	502.9	893.6	556.2	12140	875.9
400 x 200	8.0	352	90.7	71.6	18750	6460	14.4	8.44	937.5	646.0	1162	722.5	15860	1131
400 x 200	10.0	340	111	88.2	22650	7775	14.2	8.34	1132	777.5	1416	879.3	19410	1370
400 x 200	12.0	328	132	104	26250	8977	14.1	8.24	1312	897.7	1656	1026	22780	1591
400 x 200	15.0	310	161	127	31080	10580	13.9	8.10	1554	1057	1989	1230	27470	1891
400 x 250	6.0	364	75.0	59.3	16870	8253	15.0	10.5	843.4	660.3	1011	736.3	17680	1108
400 x 250	8.0	352	98.7	78.0	21820	10660	14.9	10.4	1091	852.5	1318	959.2	23200	1438
400 x 250	10.0	340	121	96.1	26460	12890	14.7	10.3	1322	1031	1611	1171	28500	1749
400 x 250	12.0	328	144	113	30770	14960	14.6	10.2	1538	1196	1889	1371	33600	2041
400 x 250	15.0	310	176	139	36640	17770	14.4	10.0	1832	1421	2278	1652	40800	2445

For explanation of table see Section 8.2.

Table 3 SQUARE HOLLOW SECTIONS

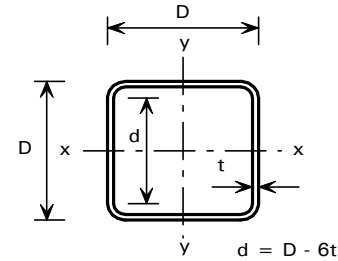

DIMENSIONS & GROSS SECTION PROPERTIES

D x D mm	t mm	d mm	Area cm ²	Mass kg/m	I_x, I_y cm ⁴	r_x, r_y cm	Z_x, Z_y cm ³	S_x, S_y cm ³	J cm ⁴	C cm ³
40 x 40	2.0	28	2.87	2.27	6.659	1.52	3.330	3.994	11.33	5.187
40 x 40	3.0	22	4.05	3.20	8.689	1.46	4.344	5.407	15.61	6.924
50 x 50	2.0	38	3.67	2.90	13.71	1.93	5.484	6.488	22.77	8.469
50 x 50	3.0	32	5.25	4.15	18.48	1.88	7.391	8.994	32.15	11.62
50 x 50	4.0	26	6.67	5.27	21.97	1.81	8.789	11.02	39.88	14.07
60 x 60	2.0	48	4.47	3.53	24.51	2.34	8.171	9.583	40.07	12.55
60 x 60	3.0	42	6.45	5.10	33.71	2.29	11.24	13.48	57.34	17.50
60 x 60	4.0	36	8.27	6.54	41.01	2.23	13.67	16.80	72.41	21.62
60 x 60	5.0	30	9.93	7.84	46.53	2.16	15.51	19.56	85.01	24.92
80 x 80	2.0	68	6.07	4.79	60.58	3.16	15.15	17.57	96.99	23.11
80 x 80	3.0	62	8.85	6.99	85.32	3.10	21.33	25.15	140.9	32.88
80 x 80	4.0	56	11.5	9.06	106.5	3.05	26.64	31.95	181.2	41.49
80 x 80	5.0	50	13.9	11.0	124.4	2.99	31.10	37.98	217.6	48.99
100 x 100	3.0	82	11.3	8.89	173.1	3.92	34.62	40.43	280.6	53.04
100 x 100	4.0	76	14.7	11.6	219.4	3.87	43.87	51.91	364.4	67.75
100 x 100	5.0	70	17.9	14.2	260.1	3.81	52.03	62.41	442.4	81.04
100 x 100	6.0	64	21.0	16.6	295.6	3.75	59.13	71.95	514.4	92.93
100 x 100	8.0	52	26.7	21.1	351.6	3.63	70.31	88.20	638.1	112.6
125 x 125	3.0	107	14.3	11.3	348.4	4.94	55.74	64.58	556.3	85.00
125 x 125	4.0	101	18.7	14.8	446.3	4.89	71.41	83.60	727.1	109.6
125 x 125	5.0	95	22.9	18.1	535.5	4.83	85.68	101.4	889.6	132.3
125 x 125	6.0	89	27.0	21.3	616.2	4.78	98.59	117.9	1043	153.3
125 x 125	8.0	77	34.7	27.4	752.9	4.66	120.5	147.5	1321	190.0
150 x 150	3.0	132	17.3	13.6	613.9	5.97	81.86	94.36	970.5	124.5
150 x 150	4.0	126	22.7	17.9	792.1	5.91	105.6	122.8	1273	161.4
150 x 150	5.0	120	27.9	22.1	957.6	5.86	127.7	149.7	1565	196.1
150 x 150	6.0	114	33.0	26.1	1110	5.80	148.1	175.2	1844	228.7
150 x 150	8.0	102	42.7	33.7	1379	5.68	184.0	221.7	2364	287.4

For explanation of table see Section 8.2.

Table 3 SQUARE HOLLOW SECTIONS

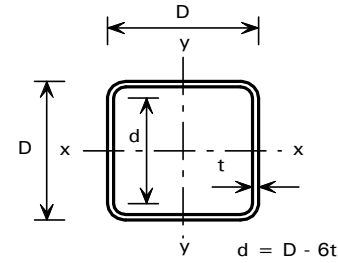

DIMENSIONS & GROSS SECTION PROPERTIES

D x D mm	t mm	d mm	Area cm ²	Mass kg/m	I_x, I_y cm ⁴	r_x, r_y cm	Z_x, Z_y cm ³	S_x, S_y cm ³	J cm ⁴	C cm ³
175 x 175	4.0	151	26.7	21.1	1281	6.93	146.5	169.5	2040	223.2
175 x 175	5.0	145	32.9	26.0	1557	6.88	178.0	207.4	2515	272.4
175 x 175	6.0	139	39.0	30.8	1815	6.82	207.5	243.7	2974	319.0
175 x 175	8.0	127	50.7	40.0	2281	6.71	260.8	311.0	3842	404.7
175 x 175	10.0	115	61.7	48.7	2682	6.59	306.6	371.5	4637	480.6
200 x 200	4.0	176	30.7	24.2	1940	7.95	194.0	223.7	3067	295.0
200 x 200	5.0	170	37.9	30.0	2366	7.90	236.7	274.5	3788	361.2
200 x 200	6.0	164	45.0	35.6	2769	7.84	277.0	323.4	4490	424.3
200 x 200	8.0	152	58.7	46.4	3509	7.73	351.0	415.3	5829	542.0
200 x 200	10.0	140	71.7	56.6	4162	7.62	416.2	499.3	7078	648.3
250 x 250	5.0	220	47.9	37.9	4737	9.94	379.0	436.9	7488	576.2
250 x 250	6.0	214	57.0	45.0	5574	9.89	445.9	516.7	8901	680.0
250 x 250	8.0	202	74.7	59.0	7141	9.78	571.3	668.8	11630	876.6
250 x 250	10.0	190	91.7	72.4	8568	9.67	685.5	811.1	14230	1058
250 x 250	12.0	178	108	85.4	9859	9.55	788.8	943.6	16690	1226
300 x 300	5.0	270	57.9	45.8	8319	12.0	554.6	636.7	13040	841.2
300 x 300	6.0	264	69.0	54.5	9823	11.9	654.9	754.9	15530	995.6
300 x 300	8.0	252	90.7	71.6	12670	11.8	845.0	982.3	20380	1291
300 x 300	10.0	240	111	88.2	15320	11.7	1021	1197	25040	1568
300 x 300	12.0	228	132	104	17770	11.6	1184	1401	29510	1829
350 x 350	6.0	314	81.0	64.0	15820	14.0	903.8	1038	24820	1371
350 x 350	8.0	302	106	84.3	20510	13.9	1171	1355	32660	1785
350 x 350	10.0	290	131	104	24920	13.8	1423	1659	40250	2179
350 x 350	12.0	278	156	123	29050	13.6	1660	1949	47600	2552
350 x 350	15.0	260	191	151	34750	13.5	1985	2358	58120	3073
400 x 400	6.0	364	93.0	73.5	23850	16.0	1192	1366	37230	1806
400 x 400	8.0	352	122	96.9	31050	15.9	1552	1789	49070	2360
400 x 400	10.0	340	151	119	37870	15.8	1893	2196	60620	2889
400 x 400	12.0	328	180	142	44320	15.7	2215	2587	71840	3394
400 x 400	15.0	310	221	174	53330	15.5	2666	3144	88050	4109

For explanation of table see Section 8.2.

Table 4 CHANNELS

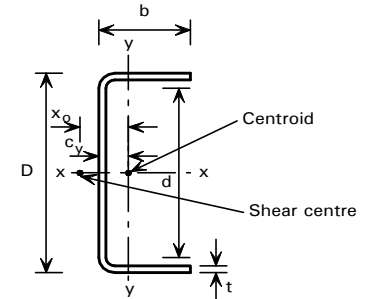

DIMENSIONS & GROSS SECTION PROPERTIES

D x b mm	t mm	Area cm ²	Mass kg/m	d mm	I _x cm ⁴	I _y cm ⁴	r _x cm	r _y cm	Z _x cm ³	Z _y cm ³	S _x cm ³	S _y cm ³	J cm ⁴	H cm ⁶	u	x	x ₀ cm	c _y cm
50 x 25	2.0	1.83	1.45	38	6.855	1.116	1.93	0.780	2.742	0.6311	3.244	1.145	0.02446	3.813	0.936	18.1	1.57	0.731
50 x 25	3.0	2.63	2.08	32	9.239	1.540	1.88	0.766	3.695	0.8997	4.497	1.633	0.07881	4.550	0.954	11.2	1.56	0.788
75 x 35	3.0	3.98	3.14	57	32.76	4.656	2.87	1.08	8.735	1.863	10.41	3.371	0.1193	35.54	0.937	18.1	2.14	1.00
75 x 35	4.0	5.14	4.06	51	40.59	5.860	2.81	1.07	10.83	2.399	13.15	4.351	0.2740	40.52	0.949	12.9	2.13	1.06
75 x 35	5.0	6.21	4.91	45	47.00	6.901	2.75	1.05	12.53	2.893	15.53	5.254	0.5178	42.81	0.963	9.77	2.12	1.11
100 x 50	3.0	5.63	4.45	82	86.56	13.94	3.92	1.57	17.31	3.881	20.21	7.033	0.1688	203.6	0.928	25.0	3.14	1.41
100 x 50	4.0	7.34	5.80	76	109.7	17.86	3.87	1.56	21.94	5.049	25.95	9.159	0.3913	244.0	0.936	18.1	3.14	1.46
100 x 50	5.0	8.96	7.08	70	130.1	21.43	3.81	1.55	26.01	6.154	31.21	11.17	0.7470	272.8	0.944	14.0	3.13	1.52
125 x 50	3.0	6.38	5.04	107	146.3	15.00	4.79	1.53	23.40	4.009	27.72	7.143	0.1913	353.2	0.921	31.7	2.88	1.26
125 x 50	4.0	8.34	6.59	101	186.5	19.28	4.73	1.52	29.85	5.226	35.75	9.360	0.4446	428.6	0.928	23.1	2.88	1.31
125 x 50	5.0	10.2	8.07	95	222.7	23.22	4.67	1.51	35.64	6.384	43.19	11.49	0.8511	485.8	0.935	17.9	2.87	1.36
125 x 50	6.0	12.0	9.49	89	255.0	26.83	4.61	1.49	40.79	7.487	50.05	13.54	1.441	526.5	0.943	14.5	2.86	1.42
150 x 60	4.0	10.1	8.01	126	332.1	34.13	5.72	1.84	44.28	7.640	52.64	13.64	0.5406	1136	0.923	28.3	3.46	1.53
150 x 60	5.0	12.5	9.85	120	399.9	41.38	5.66	1.82	53.32	9.370	63.99	16.80	1.039	1311	0.929	22.1	3.45	1.58
150 x 60	6.0	14.7	11.6	114	461.9	48.14	5.60	1.81	61.58	11.03	74.63	19.86	1.765	1450	0.935	17.9	3.45	1.64
150 x 60	8.0	18.9	15.0	102	568.8	60.25	5.48	1.78	75.83	14.15	93.82	25.66	4.042	1627	0.949	12.7	3.43	1.74
175 x 60	5.0	13.7	10.8	145	580.0	43.43	6.50	1.78	66.29	9.570	80.35	17.05	1.143	1934	0.919	26.2	3.23	1.46
175 x 60	6.0	16.2	12.8	139	672.2	50.62	6.44	1.77	76.82	11.28	93.96	20.22	1.945	2153	0.924	21.3	3.22	1.51
175 x 60	8.0	20.9	16.5	127	834.0	63.62	6.31	1.74	95.31	14.51	118.8	26.32	4.469	2455	0.937	15.2	3.21	1.62
175 x 60	10.0	25.4	20.0	115	966.5	74.91	6.17	1.72	110.5	17.51	140.4	32.08	8.451	2594	0.951	11.5	3.18	1.72
200 x 75	5.0	16.5	13.0	170	945.6	85.02	7.58	2.27	94.56	15.05	112.9	26.76	1.372	5085	0.920	30.3	4.21	1.85
200 x 75	6.0	19.5	15.4	164	1102	99.62	7.52	2.26	110.3	17.80	132.6	31.78	2.341	5742	0.924	24.8	4.20	1.90
200 x 75	8.0	25.3	20.0	152	1385	126.5	7.39	2.23	138.6	23.03	169.2	41.46	5.407	6746	0.934	17.9	4.19	2.01
200 x 75	10.0	30.9	24.4	140	1629	150.6	7.27	2.21	162.9	27.94	202.1	50.66	10.28	7379	0.944	13.7	4.17	2.11
225 x 75	6.0	21.0	16.6	189	1465	103.2	8.35	2.22	130.3	18.07	157.9	32.13	2.521	7713	0.916	28.2	3.99	1.79
225 x 75	8.0	27.3	21.6	177	1849	131.4	8.22	2.19	164.4	23.42	202.2	42.09	5.834	9139	0.924	20.4	3.97	1.89
225 x 75	10.0	33.4	26.3	165	2184	156.8	8.09	2.17	194.2	28.46	242.3	51.65	11.12	10090	0.934	15.7	3.96	1.99
225 x 75	12.0	39.0	30.8	153	2470	179.5	7.96	2.14	219.6	33.21	278.3	60.81	18.73	10620	0.945	12.6	3.93	2.10
250 x 100	6.0	25.5	20.2	214	2340	239.9	9.58	3.07	187.2	32.07	221.7	57.14	3.061	22600	0.921	31.7	5.77	2.52
250 x 100	8.0	33.3	26.3	202	2984	308.4	9.46	3.04	238.8	41.80	286.0	74.88	7.114	27430	0.928	23.1	5.76	2.62
250 x 100	10.0	40.9	32.3	190	3563	371.5	9.34	3.02	285.1	51.07	345.5	91.94	13.62	31090	0.935	17.9	5.75	2.73
250 x 100	12.0	48.0	37.9	178	4079	429.2	9.22	2.99	326.3	59.89	400.4	108.3	23.05	33690	0.943	14.5	5.73	2.83

For explanation of table see Section 8.2.

Table 4 CHANNELS

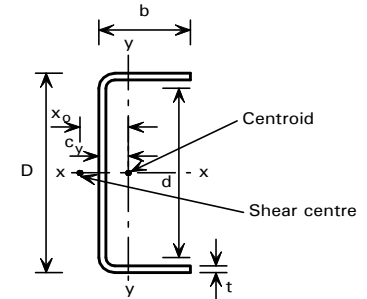

DIMENSIONS & GROSS SECTION PROPERTIES

D x b mm	t mm	Area cm ²	Mass kg/m	d mm	I _x cm ⁴	I _y cm ⁴	r _x cm	r _y cm	Z _x cm ³	Z _y cm ³	S _x cm ³	S _y cm ³	J cm ⁴	H cm ⁶	u	x	x ₀ cm	c _y cm
300 x 100	8.0	37.3	29.5	252	4631	326.3	11.1	2.96	308.8	42.84	374.4	76.15	7.967	43340	0.916	28.2	5.32	2.38
300 x 100	10.0	45.9	36.2	240	5557	394.0	11.0	2.93	370.5	52.42	453.9	93.95	15.28	49610	0.922	22.0	5.31	2.48
300 x 100	12.0	54.0	42.7	228	6393	456.6	10.9	2.91	426.3	61.58	528.0	111.2	25.93	54340	0.929	17.8	5.29	2.59
300 x 100	15.0	65.7	51.9	210	7486	541.3	10.7	2.87	499.1	74.58	628.8	136.1	49.25	58820	0.941	13.6	5.25	2.74
350 x 125	8.0	45.3	35.8	302	7914	642.0	13.2	3.76	452.3	67.52	541.1	119.6	9.674	119500	0.916	33.4	6.87	2.99
350 x 125	10.0	55.9	44.1	290	9569	780.3	13.1	3.74	546.8	82.93	659.8	147.8	18.62	139100	0.921	26.2	6.86	3.09
350 x 125	12.0	66.0	52.2	278	11100	910.2	13.0	3.71	634.2	97.79	771.9	175.2	31.69	155200	0.926	21.3	6.84	3.19
350 x 125	15.0	80.7	63.7	260	13160	1089	12.8	3.68	752.1	119.1	928.0	215.0	60.50	173100	0.935	16.5	6.82	3.35
400 x 150	8.0	53.3	42.1	352	12450	1114	15.3	4.57	622.5	97.77	737.9	173.1	11.38	276300	0.915	38.6	8.42	3.60
400 x 150	10.0	65.9	52.0	340	15130	1360	15.2	4.54	756.5	120.4	903.2	214.1	21.95	325500	0.920	30.3	8.41	3.70
400 x 150	12.0	78.0	61.6	328	17640	1593	15.0	4.52	882.1	142.4	1060	254.2	37.45	367500	0.924	24.8	8.41	3.80
400 x 150	15.0	95.7	75.6	310	21100	1921	14.9	4.48	1055	174.0	1283	312.7	71.75	418100	0.931	19.3	8.39	3.96

For explanation of table see Section 8.2.

Table 5 DOUBLE CHANNELS BACK TO BACK

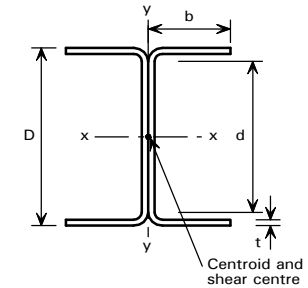

DIMENSIONS & GROSS SECTION PROPERTIES

D x 2b	t	Area	Mass	d	I _x	I _y	r _x	r _y	Z _x	Z _y	S _x	S _y	J	H	u	x
mm	mm	cm ²	kg/m	mm	cm ⁴	cm ⁴	cm	cm	cm ³	cm ³	cm ³	cm ³	cm ⁴	cm ⁶		
50 x 50	2.0	3.67	2.90	38	13.71	4.194	1.93	1.07	5.484	1.678	6.488	2.682	0.04891	17.43	0.850	20.0
50 x 50	3.0	5.25	4.15	32	18.48	6.343	1.88	1.10	7.391	2.537	8.994	4.140	0.1576	20.80	0.875	11.8
75 x 70	3.0	7.95	6.28	57	65.51	17.29	2.87	1.47	17.47	4.940	20.82	7.965	0.2386	158.7	0.861	19.8
75 x 70	4.0	10.3	8.12	51	81.19	23.20	2.81	1.50	21.65	6.628	26.30	10.86	0.5479	180.9	0.880	13.7
75 x 70	5.0	12.4	9.82	45	94.00	29.23	2.75	1.53	25.07	8.353	31.06	13.85	1.036	191.1	0.901	10.0
100 x 100	3.0	11.3	8.89	82	173.1	50.18	3.92	2.11	34.62	10.04	40.43	15.84	0.3376	930.7	0.838	28.1
100 x 100	4.0	14.7	11.6	76	219.4	67.10	3.87	2.14	43.87	13.42	51.91	21.46	0.7826	1115	0.850	20.0
100 x 100	5.0	17.9	14.2	70	260.1	84.19	3.81	2.17	52.03	16.84	62.41	27.22	1.494	1247	0.862	15.1
125 x 100	3.0	12.8	10.1	107	292.6	50.23	4.79	1.98	46.81	10.05	55.43	16.07	0.3826	1497	0.851	35.7
125 x 100	4.0	16.7	13.2	101	373.1	67.21	4.73	2.01	59.69	13.44	71.50	21.86	0.8892	1816	0.864	25.5
125 x 100	5.0	20.4	16.1	95	445.5	84.40	4.67	2.03	71.28	16.88	86.38	27.85	1.702	2057	0.878	19.4
125 x 100	6.0	24.0	19.0	89	509.9	101.9	4.61	2.06	81.59	20.37	100.1	34.02	2.882	2228	0.893	15.3
150 x 120	4.0	20.3	16.0	126	664.2	115.9	5.72	2.39	88.56	19.31	105.3	31.06	1.081	4817	0.855	31.6
150 x 120	5.0	24.9	19.7	120	799.8	145.3	5.66	2.41	106.6	24.21	128.0	39.47	2.077	5559	0.866	24.3
150 x 120	6.0	29.4	23.2	114	923.7	175.0	5.60	2.44	123.2	29.17	149.3	48.12	3.530	6144	0.878	19.4
150 x 120	8.0	37.9	29.9	102	1137	235.7	5.48	2.49	151.7	39.28	187.6	66.07	8.084	6885	0.903	13.2
175 x 120	5.0	27.4	21.7	145	1160	145.5	6.50	2.30	132.6	24.25	160.7	40.10	2.286	7775	0.866	28.7
175 x 120	6.0	32.4	25.6	139	1344	175.4	6.44	2.33	153.6	29.23	187.9	49.02	3.890	8649	0.877	22.9
175 x 120	8.0	41.9	33.1	127	1667	236.5	6.31	2.38	190.6	39.42	237.5	67.67	8.937	9839	0.902	15.8
175 x 120	10.0	50.7	40.1	115	1932	300.1	6.17	2.43	220.9	50.01	280.8	87.29	16.90	10380	0.930	11.5
200 x 150	5.0	32.9	26.0	170	1891	282.9	7.58	2.93	189.1	37.73	225.8	60.97	2.744	21100	0.856	33.9
200 x 150	6.0	39.0	30.8	164	2205	340.4	7.52	2.95	220.5	45.39	265.2	74.22	4.682	23810	0.865	27.3
200 x 150	8.0	50.7	40.0	152	2771	457.0	7.39	3.00	277.2	60.93	338.5	101.7	10.81	27940	0.883	19.2
200 x 150	10.0	61.7	48.7	140	3258	576.3	7.27	3.06	325.9	76.83	404.3	130.3	20.57	30520	0.904	14.3
225 x 150	6.0	42.0	33.2	189	2930	340.8	8.35	2.85	260.5	45.44	315.9	75.12	5.042	30710	0.863	31.0
225 x 150	8.0	54.7	43.2	177	3699	457.9	8.22	2.89	328.8	61.05	404.3	103.3	11.67	36330	0.881	21.8
225 x 150	10.0	66.7	52.7	165	4368	577.9	8.09	2.94	388.3	77.06	484.5	132.8	22.24	40050	0.902	16.3
225 x 150	12.0	78.1	61.7	153	4941	701.8	7.96	3.00	439.2	93.57	556.6	163.6	37.47	42090	0.924	12.7
250 x 200	6.0	51.0	40.3	214	4680	803.7	9.58	3.97	374.5	80.37	443.5	128.5	6.122	95870	0.851	35.7
250 x 200	8.0	66.7	52.7	202	5969	1075	9.46	4.02	477.6	107.5	572.0	174.9	14.23	116300	0.864	25.5
250 x 200	10.0	81.7	64.5	190	7127	1350	9.34	4.07	570.2	135.0	691.1	222.8	27.24	131700	0.878	19.4
250 x 200	12.0	96.1	75.9	178	8158	1629	9.22	4.12	652.7	163.0	800.8	272.2	46.11	142600	0.893	15.3

For explanation of table see Section 8.2.

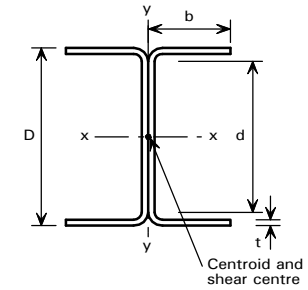
Table 5 DOUBLE CHANNELS BACK TO BACK**DIMENSIONS & GROSS SECTION PROPERTIES**

D x 2b mm	t mm	Area cm ²	Mass kg/m	d mm	I _x cm ⁴	I _y cm ⁴	r _x cm	r _y cm	Z _x cm ³	Z _y cm ³	S _x cm ³	S _y cm ³	J cm ⁴	H cm ⁶	u	x
300 x 200	8.0	74.7	59.0	252	9262	1077	11.1	3.80	617.5	107.7	748.7	178.1	15.93	172600	0.863	31.0
300 x 200	10.0	91.7	72.4	240	11110	1353	11.0	3.84	741.0	135.4	907.8	227.8	30.57	197300	0.877	23.7
300 x 200	12.0	108	85.4	228	12790	1635	10.9	3.89	852.5	163.5	1055	279.4	51.87	215800	0.891	18.8
300 x 200	15.0	131	103	210	14970	2069	10.7	3.97	998.2	207.0	1257	360.0	98.51	233200	0.915	13.9
350 x 250	8.0	90.7	71.6	302	15830	2095	13.2	4.81	904.6	167.6	1082	271.3	19.35	487500	0.854	37.4
350 x 250	10.0	111	88.2	290	19140	2627	13.1	4.85	1093	210.2	1319	345.3	37.24	567100	0.864	28.8
350 x 250	12.0	132	104	278	22200	3166	13.0	4.90	1268	253.3	1543	421.6	63.39	632100	0.875	23.1
350 x 250	15.0	161	127	260	26320	3987	12.8	4.97	1504	319.0	1855	540.0	121.0	704300	0.893	17.4
400 x 300	8.0	106	84.3	352	24900	3613	15.3	5.82	1244	240.9	1475	384.5	22.76	1147000	0.847	43.7
400 x 300	10.0	131	104	340	30260	4527	15.2	5.86	1512	301.8	1806	487.8	43.90	1350000	0.856	33.9
400 x 300	12.0	156	123	328	35280	5446	15.0	5.91	1764	363.1	2121	593.8	74.91	1524000	0.865	27.3
400 x 300	15.0	191	151	310	42210	6842	14.9	5.98	2110	456.1	2566	757.5	143.5	1732000	0.879	20.8

For explanation of table see Section 8.2.

Table 6 EQUAL ANGLES

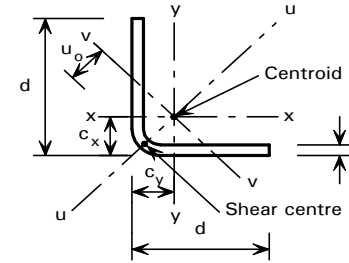

DIMENSIONS & GROSS SECTION PROPERTIES

d x d mm	t mm	Area cm ²	Mass kg/m	I_x, I_y cm ⁴	I_u cm ⁴	I_v cm ⁴	r_x, r_y cm	r_u cm	r_v cm	Z_x, Z_y cm ³	Z_u cm ³	Z_v cm ³	J cm ⁴	H cm ⁶	c_x, c_y cm	u_0 cm
50 x 50	5.0	4.48	3.54	10.71	17.86	3.563	1.55	2.00	0.892	3.077	5.052	2.046	0.3735	0.5758	1.52	1.65
50 x 50	6.0	5.25	4.15	12.32	20.75	3.896	1.53	1.99	0.861	3.599	5.868	2.251	0.6304	0.9039	1.58	1.59
50 x 50	8.0	6.67	5.27	15.04	25.83	4.241	1.50	1.97	0.797	4.551	7.307	2.490	1.424	1.733	1.70	1.46
50 x 50	10.0	7.93	6.26	17.11	29.97	4.243	1.47	1.94	0.732	5.384	8.477	2.548	2.642	2.644	1.82	1.29
75 x 75	6.0	8.25	6.52	45.21	74.68	15.74	2.34	3.01	1.38	8.520	14.08	5.997	0.9904	3.676	2.19	2.54
75 x 75	8.0	10.7	8.43	57.05	95.43	18.66	2.31	2.99	1.32	10.98	17.99	7.159	2.277	7.714	2.31	2.45
75 x 75	10.0	12.9	10.2	67.33	114.1	20.53	2.28	2.97	1.26	13.26	21.52	7.946	4.309	13.20	2.42	2.33
75 x 75	12.0	15.0	11.9	76.13	130.8	21.47	2.25	2.95	1.20	15.36	24.66	8.405	7.207	19.74	2.54	2.19
100 x 100	8.0	14.7	11.6	142.9	236.0	49.76	3.12	4.01	1.84	20.20	33.38	14.22	3.130	20.66	2.92	3.38
100 x 100	10.0	17.9	14.2	171.4	285.8	57.00	3.09	3.99	1.78	24.62	40.42	16.37	5.976	36.85	3.04	3.29
100 x 100	12.0	21.0	16.6	197.2	332.0	62.33	3.06	3.97	1.72	28.79	46.95	18.01	10.09	57.85	3.15	3.19
100 x 100	15.0	25.3	20.0	230.7	394.4	67.06	3.02	3.95	1.63	34.59	55.77	19.60	19.00	96.66	3.33	2.99
120 x 120	8.0	17.9	14.1	253.6	416.4	90.84	3.77	4.83	2.25	29.57	49.07	21.57	3.813	37.82	3.42	4.12
120 x 120	10.0	21.9	17.3	306.6	507.1	106.0	3.74	4.81	2.20	36.20	59.77	25.25	7.309	68.70	3.53	4.04
120 x 120	12.0	25.8	20.4	355.4	592.6	118.2	3.71	4.79	2.14	42.54	69.84	28.28	12.39	110.0	3.64	3.95
120 x 120	15.0	31.3	24.8	421.3	711.1	131.4	3.67	4.76	2.05	51.49	83.81	31.69	23.50	190.4	3.82	3.79
150 x 150	8.0	22.7	17.9	508.6	830.2	187.0	4.74	6.05	2.87	46.96	78.27	35.43	4.837	78.09	4.17	5.21
150 x 150	10.0	27.9	22.1	619.2	1016	221.8	4.71	6.03	2.82	57.75	95.85	42.13	9.309	144.3	4.28	5.15
150 x 150	12.0	33.0	26.1	723.4	1194	251.9	4.68	6.02	2.76	68.16	112.7	47.98	15.85	235.3	4.39	5.08
150 x 150	15.0	40.3	31.9	867.7	1446	288.6	4.64	5.99	2.67	83.08	136.4	55.24	30.25	419.8	4.56	4.94
200 x 200	8.0	30.7	24.2	1237	2008	465.9	6.35	8.09	3.90	84.83	142.0	66.10	6.544	195.4	5.42	7.00
200 x 200	10.0	37.9	30.0	1516	2472	561.1	6.32	8.07	3.85	104.8	174.8	79.71	12.64	366.5	5.52	6.96
200 x 200	12.0	45.0	35.6	1784	2921	647.8	6.30	8.06	3.79	124.2	206.6	92.17	21.61	607.7	5.63	6.90
200 x 200	15.0	55.3	43.7	2165	3568	762.2	6.26	8.03	3.71	152.4	252.3	108.8	41.50	1113	5.79	6.81

For explanation of table see Section 8.2.

Table 7 DOUBLE ANGLES BACK TO BACK

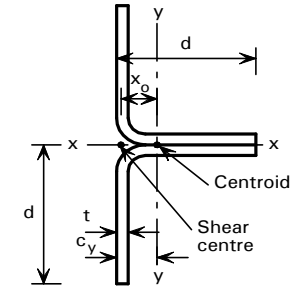

DIMENSIONS & GROSS SECTION PROPERTIES

2d x d mm	t mm	Area cm ²	Mass kg/m	I _x cm ⁴	I _y cm ⁴	r _x cm	r _y cm	Z _x cm ³	Z _y cm ³	J cm ⁴	H cm ⁶	c _y cm	x ₀ cm
100 x 50	5.0	8.96	7.08	42.10	21.43	2.17	1.55	8.419	6.154	0.7470	1.152	1.52	1.16
100 x 50	6.0	10.5	8.30	50.75	24.64	2.20	1.53	10.15	7.198	1.261	1.808	1.58	1.13
100 x 50	8.0	13.3	10.5	68.46	30.07	2.26	1.50	13.69	9.102	2.847	3.467	1.70	1.03
100 x 50	10.0	15.9	12.5	86.88	34.21	2.34	1.47	17.38	10.77	5.285	5.288	1.82	0.912
150 x 75	6.0	16.5	13.0	169.9	90.42	3.21	2.34	22.65	17.04	1.981	7.353	2.19	1.79
150 x 75	8.0	21.3	16.9	227.6	114.1	3.27	2.31	30.35	21.97	4.554	15.43	2.31	1.73
150 x 75	10.0	25.9	20.4	286.5	134.7	3.33	2.28	38.19	26.53	8.618	26.41	2.42	1.65
150 x 75	12.0	30.0	23.7	346.6	152.3	3.40	2.25	46.21	30.72	14.41	39.49	2.54	1.55
200 x 100	8.0	29.3	23.2	536.8	285.8	4.28	3.12	53.68	40.39	6.261	41.31	2.92	2.39
200 x 100	10.0	35.9	28.3	673.5	342.8	4.33	3.09	67.35	49.23	11.95	73.70	3.04	2.33
200 x 100	12.0	42.0	33.2	812.0	394.3	4.40	3.06	81.20	57.58	20.17	115.7	3.15	2.25
200 x 100	15.0	50.7	40.0	1023	461.4	4.49	3.02	102.4	69.19	38.00	193.3	3.33	2.11
240 x 120	8.0	35.7	28.2	925.8	507.3	5.09	3.77	77.15	59.13	7.626	75.63	3.42	2.91
240 x 120	10.0	43.9	34.6	1160	613.1	5.14	3.74	96.68	72.40	14.62	137.4	3.53	2.86
240 x 120	12.0	51.6	40.8	1396	710.8	5.20	3.71	116.4	85.08	24.78	220.1	3.64	2.80
240 x 120	15.0	62.7	49.5	1756	842.6	5.29	3.67	146.3	103.0	47.00	380.9	3.82	2.68
300 x 150	8.0	45.3	35.8	1805	1017	6.31	4.74	120.3	93.91	9.674	156.2	4.17	3.68
300 x 150	10.0	55.9	44.1	2260	1238	6.36	4.71	150.7	115.5	18.62	288.5	4.28	3.64
300 x 150	12.0	66.0	52.2	2717	1446	6.42	4.68	181.2	136.3	31.69	470.6	4.39	3.59
300 x 150	15.0	80.7	63.7	3409	1735	6.50	4.64	227.3	166.2	60.50	839.5	4.56	3.49
400 x 200	8.0	61.3	48.5	4273	2474	8.35	6.35	213.7	169.7	13.09	390.8	5.42	4.95
400 x 200	10.0	75.9	59.9	5346	3033	8.40	6.32	267.3	209.5	25.28	733.0	5.52	4.92
400 x 200	12.0	90.0	71.1	6423	3569	8.45	6.30	321.2	248.4	43.21	1215	5.63	4.88
400 x 200	15.0	110	87.4	8046	4330	8.53	6.26	402.3	304.8	83.00	2226	5.79	4.81

For explanation of table see Section 8.2.

[Blank Page]

B. SECTION CLASSIFICATION AND EFFECTIVE SECTION PROPERTIES

Note: Sections in duplex stainless steel grades 1.4362 (SAF 2304) and 1.4462 (2205) are less widely available on an ex-stock supply basis. Before proceeding with designs it is advisable to check availability with suppliers.

Table 8 CIRCULAR HOLLOW SECTIONS

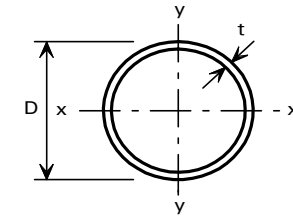

CLASSIFICATION FOR SECTIONS SUBJECT TO AXIAL COMPRESSION

D mm	t mm	1.4301 (304)	1.4401 (316) and 1.4404 (316L)	1.4362 (SAF 2304)	1.4462 (2205)
48.3	1.0	Non Slender	Non Slender	Non Slender	Slender
60.3	1.0	Non Slender	Non Slender	Slender	Slender
76.1	1.0	Non Slender	Non Slender	Slender	Slender
	1.6	Non Slender	Non Slender	Non Slender	Slender
88.9	1.0	Non Slender	Non Slender	Slender	Slender
	1.6	Non Slender	Non Slender	Slender	Slender
	2.0	Non Slender	Non Slender	Non Slender	Slender
101.6	1.0	Slender	Slender	Slender	Slender
	1.6	Non Slender	Non Slender	Slender	Slender
	2.0	Non Slender	Non Slender	Slender	Slender
114.3	1.2	Slender	Slender	Slender	Slender
	1.6	Non Slender	Non Slender	Slender	Slender
	2.0	Non Slender	Non Slender	Slender	Slender
	2.6	Non Slender	Non Slender	Non Slender	Slender
139.7	1.2	Slender	Slender	Slender	Slender
	1.6	Non Slender	Non Slender	Slender	Slender

D mm	t mm	1.4301 (304)	1.4401 (316) and 1.4404 (316L)	1.4362 (SAF 2304)	1.4462 (2205)
139.7	2.0	Non Slender	Non Slender	Slender	Slender
	2.6	Non Slender	Non Slender	Slender	Slender
	3.2	Non Slender	Non Slender	Non Slender	Slender
168.3	1.6	Slender	Slender	Slender	Slender
	2.0	Non Slender	Non Slender	Slender	Slender
	2.6	Non Slender	Non Slender	Slender	Slender
	3.2	Non Slender	Non Slender	Slender	Slender
219.1	2.0	Slender	Slender	Slender	Slender
	2.6	Non Slender	Non Slender	Slender	Slender
	3.2	Non Slender	Non Slender	Slender	Slender
	4.0	Non Slender	Non Slender	Slender	Slender
	5.0	Non Slender	Non Slender	Non Slender	Slender
273	2.6	Slender	Slender	Slender	Slender
	3.2	Non Slender	Non Slender	Slender	Slender
	4.0	Non Slender	Non Slender	Slender	Slender
	5.0	Non Slender	Non Slender	Slender	Slender

Only the sections which can be slender under axial compression are given in the table.

No guidance is available on the calculation of effective areas for slender stainless steel circular hollow sections.

For explanation of table see Section 8.3.

Table 9 RECTANGULAR HOLLOW SECTIONS

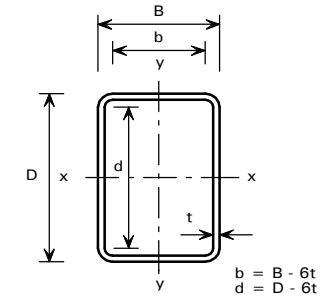

CLASSIFICATION & EFFECTIVE AREA FOR SECTIONS SUBJECT TO AXIAL COMPRESSION

D x B mm	t mm	Gross Area A _g cm ²	1.4301 (304)			1.4401 (316) and 1.4404 (316L)			1.4362 (SAF 2304)			1.4462 (2205)						
			Classification		Effective Area A _{eff} cm ²	β _c	Classification		Effective Area A _{eff} cm ²	β _c	Classification		Effective Area A _{eff} cm ²	β _c				
50 x 25	1.5	2.06	Non Slender		2.06	1.00	Non Slender		2.06	1.00	Slender	W	1.93	0.935	Slender	W	1.88	0.910
60 x 30	2.0	3.27	Non Slender		3.27	1.00	Non Slender		3.27	1.00	Slender	W	3.21	0.983	Slender	W	3.13	0.958
80 x 40	2.0	4.47	Slender	W	4.35	0.973	Slender	W	4.31	0.964	Slender	W	3.83	0.857	Slender	W	3.73	0.834
100 x 50	2.0	5.67	Slender	W	4.97	0.876	Slender	W	4.92	0.868	Slender	W	4.37	0.771	Slender	W	4.25	0.750
	3.0	8.25	Non Slender		8.25	1.00	Non Slender		8.25	1.00	Slender	W	7.72	0.935	Slender	W	7.51	0.910
150 x 75	3.0	12.8	Slender	W	11.2	0.876	Slender	W	11.1	0.868	Slender	W	9.83	0.771	Slender	W	9.57	0.750
	4.0	16.7	Non Slender		16.7	1.00	Slender	W	16.6	0.993	Slender	W	14.7	0.884	Slender	W	14.3	0.860
	5.0	20.4	Non Slender		20.4	1.00	Non Slender		20.4	1.00	Slender	W	20.1	0.983	Slender	W	19.6	0.958
150 x 100	3.0	14.3	Slender	W	12.7	0.889	Slender	W	12.6	0.882	Slender	FW	10.8	0.757	Slender	FW	10.3	0.725
	4.0	18.7	Non Slender		18.7	1.00	Slender	W	18.6	0.994	Slender	W	16.7	0.896	Slender	W	16.3	0.875
	5.0	22.9	Non Slender		22.9	1.00	Non Slender		22.9	1.00	Slender	W	22.6	0.985	Slender	W	22.1	0.962
200 x 100	4.0	22.7	Slender	W	19.9	0.876	Slender	W	19.7	0.868	Slender	W	17.5	0.771	Slender	W	17.0	0.750
	5.0	27.9	Slender	W	27.2	0.973	Slender	W	26.9	0.964	Slender	W	23.9	0.857	Slender	W	23.3	0.834
	6.0	33.0	Non Slender		33.0	1.00	Non Slender		33.0	1.00	Slender	W	30.9	0.935	Slender	W	30.1	0.910
200 x 125	4.0	24.7	Slender	W	21.9	0.886	Slender	W	21.7	0.879	Slender	FW	19.0	0.770	Slender	FW	18.2	0.737
	5.0	30.4	Slender	W	29.7	0.975	Slender	W	29.4	0.967	Slender	W	26.4	0.869	Slender	W	25.8	0.847
	6.0	36.0	Non Slender		36.0	1.00	Non Slender		36.0	1.00	Slender	W	33.9	0.941	Slender	W	33.1	0.918

β_c is 1.0 for non slender sections and A_{eff}/A_g for slender sections.

W indicates that the web is slender

F indicates that the flange is slender

Only the sections which can be slender under axial compression are given in the table.

Values of A_{eff} in **bold type** are less than the gross area.

For explanation of table see Section 8.3.

Table 9 RECTANGULAR HOLLOW SECTIONS

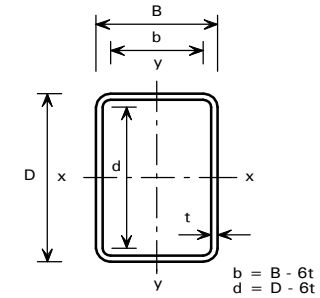

CLASSIFICATION & EFFECTIVE AREA FOR SECTIONS SUBJECT TO AXIAL COMPRESSION

D x B mm	t mm	Gross Area A _g cm ²	1.4301 (304)			1.4401 (316) and 1.4404 (316L)			1.4362 (SAF 2304)			1.4462 (2205)						
			Classification		Effective Area A _{eff} cm ²	β _c	Classification		Effective Area A _{eff} cm ²	β _c	Classification		Effective Area A _{eff} cm ²	β _c				
250 x 125	6.0	42.0	Slender	W	40.1	0.954	Slender	W	39.7	0.946	Slender	W	35.3	0.840	Slender	W	34.4	0.818
	8.0	54.7	Non Slender		54.7	1.00	Non Slender		54.7	1.00	Slender	W	52.7	0.964	Slender	W	51.4	0.939
250 x 150	6.0	45.0	Slender	W	43.1	0.957	Slender	W	42.7	0.949	Slender	W	38.3	0.851	Slender	W	37.4	0.830
	8.0	58.7	Non Slender		58.7	1.00	Non Slender		58.7	1.00	Slender	W	56.7	0.967	Slender	W	55.4	0.943
300 x 150	6.0	51.0	Slender	W	44.7	0.876	Slender	W	44.3	0.868	Slender	W	39.3	0.771	Slender	W	38.3	0.750
	8.0	66.7	Non Slender		66.7	1.00	Slender	W	66.2	0.993	Slender	W	58.9	0.884	Slender	W	57.4	0.860
	10.0	81.7	Non Slender		81.7	1.00	Non Slender		81.7	1.00	Slender	W	80.3	0.983	Slender	W	78.2	0.958
300 x 200	6.0	57.0	Slender	W	50.7	0.889	Slender	W	50.3	0.882	Slender	FW	43.2	0.757	Slender	FW	41.3	0.725
	8.0	74.7	Non Slender		74.7	1.00	Slender	W	74.2	0.994	Slender	W	66.9	0.896	Slender	W	65.4	0.875
	10.0	91.7	Non Slender		91.7	1.00	Non Slender		91.7	1.00	Slender	W	90.3	0.985	Slender	W	88.2	0.962
350 x 175	6.0	60.0	Slender	W	48.9	0.816	Slender	W	48.5	0.808	Slender	FW	43.0	0.716	Slender	FW	41.1	0.685
	8.0	78.7	Slender	W	73.4	0.933	Slender	W	72.7	0.924	Slender	W	64.6	0.821	Slender	W	62.9	0.799
	10.0	96.7	Non Slender		96.7	1.00	Non Slender		96.7	1.00	Slender	W	88.3	0.914	Slender	W	86.0	0.889
	12.0	114	Non Slender		114	1.00	Non Slender		114	1.00	Slender	W	113	0.996	Slender	W	110	0.971
350 x 200	6.0	63.0	Slender	W	51.9	0.824	Slender	W	51.5	0.817	Slender	FW	43.9	0.697	Slender	FW	42.0	0.666
	8.0	82.7	Slender	W	77.4	0.936	Slender	W	76.7	0.928	Slender	W	68.6	0.830	Slender	W	66.9	0.809
	10.0	101	Non Slender		101	1.00	Non Slender		101	1.00	Slender	W	93.3	0.918	Slender	W	91.0	0.895
	12.0	120	Non Slender		120	1.00	Non Slender		120	1.00	Slender	W	119	0.996	Slender	W	116	0.972

β_c is 1.0 for non slender sections and A_{eff}/A_g for slender sections.

W indicates that the web is slender

F indicates that the flange is slender

Only the sections which can be slender under axial compression are given in the table.

Values of A_{eff} in **bold type** are less than the gross area.

For explanation of table see Section 8.3.

Table 9 RECTANGULAR HOLLOW SECTIONS

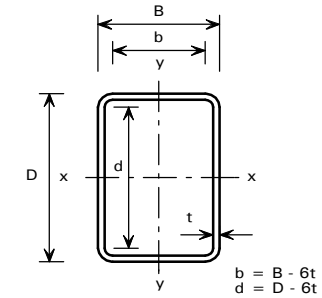

CLASSIFICATION & EFFECTIVE AREA FOR SECTIONS SUBJECT TO AXIAL COMPRESSION

D x B mm	t mm	Gross Area A_g cm ²	1.4301 (304)			1.4401 (316) and 1.4404 (316L)			1.4362 (SAF 2304)			1.4462 (2205)						
			Classification		Effective Area A_{eff} cm ²	β_c	Classification		Effective Area A_{eff} cm ²	β_c	Classification		Effective Area A_{eff} cm ²	β_c	Classification		Effective Area A_{eff} cm ²	β_c
400 x 200	6.0	69.0	Slender	W	52.9	0.767	Slender	W	52.4	0.760	Slender	FW	44.5	0.645	Slender	FW	42.5	0.616
	8.0	90.7	Slender	W	79.5	0.876	Slender	W	78.7	0.868	Slender	W	69.9	0.771	Slender	W	68.0	0.750
	10.0	111	Slender	W	108	0.973	Slender	W	107	0.964	Slender	W	95.7	0.857	Slender	W	93.1	0.834
	12.0	132	Non Slender		132	1.00	Non Slender		132	1.00	Slender	W	123	0.935	Slender	W	120	0.910
400 x 250	6.0	75.0	Slender	FW	57.0	0.760	Slender	FW	56.1	0.748	Slender	FW	46.0	0.613	Slender	FW	43.8	0.584
	8.0	98.7	Slender	W	87.5	0.886	Slender	W	86.7	0.879	Slender	FW	76.0	0.770	Slender	FW	72.7	0.737
	10.0	121	Slender	W	118	0.975	Slender	W	117	0.967	Slender	W	105	0.869	Slender	W	103	0.847
	12.0	144	Non Slender		144	1.00	Non Slender		144	1.00	Slender	W	135	0.941	Slender	W	132	0.918

β_c is 1.0 for non slender sections and A_{eff}/A_g for slender sections.

W indicates that the web is slender

F indicates that the flange is slender

Only the sections which can be slender under axial compression are given in the table.

Values of A_{eff} in **bold type** are less than the gross area.

For explanation of table see Section 8.3.

Table 10 SQUARE HOLLOW SECTIONS

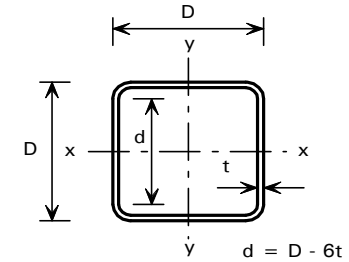

CLASSIFICATION & EFFECTIVE AREA FOR SECTIONS SUBJECT TO AXIAL COMPRESSION

D x D mm	t mm	Gross Area A _g cm ²	1.4301 (304)			1.4401 (316) and 1.4404 (316L)			1.4362 (SAF 2304)			1.4462 (2205)						
			Classification		Effective Area A _{eff} cm ²	β _c	Classification		Effective Area A _{eff} cm ²	β _c	Classification		Effective Area A _{eff} cm ²	β _c				
60 x 60	2.0	4.47	Non Slender		4.47	1.00	Non Slender		4.47	1.00	Slender	FW	4.36	0.975	Slender	FW	4.19	0.938
80 x 80	2.0	6.07	Slender	FW	5.82	0.960	Slender	FW	5.74	0.947	Slender	FW	4.79	0.789	Slender	FW	4.58	0.755
100 x 100	3.0	11.3	Non Slender		11.3	1.00	Non Slender		11.3	1.00	Slender	FW	10.2	0.905	Slender	FW	9.77	0.868
125 x 125	3.0	14.3	Slender	FW	13.3	0.933	Slender	FW	13.1	0.920	Slender	FW	10.9	0.765	Slender	FW	10.4	0.731
	4.0	18.7	Non Slender		18.7	1.00	Non Slender		18.7	1.00	Slender	FW	17.7	0.948	Slender	FW	17.0	0.911
150 x 150	3.0	17.3	Slender	FW	14.1	0.817	Slender	FW	13.9	0.805	Slender	FW	11.4	0.661	Slender	FW	10.9	0.631
	4.0	22.7	Non Slender		22.7	1.00	Slender	FW	22.4	0.990	Slender	FW	18.8	0.829	Slender	FW	18.0	0.794
	5.0	27.9	Non Slender		27.9	1.00	Non Slender		27.9	1.00	Slender	FW	27.2	0.975	Slender	FW	26.2	0.938
175 x 175	4.0	26.7	Slender	FW	24.0	0.901	Slender	FW	23.7	0.888	Slender	FW	19.6	0.736	Slender	FW	18.8	0.703
	5.0	32.9	Non Slender		32.9	1.00	Non Slender		32.9	1.00	Slender	FW	28.7	0.873	Slender	FW	27.6	0.837
	6.0	39.0	Non Slender		39.0	1.00	Non Slender		39.0	1.00	Slender	FW	38.8	0.994	Slender	FW	37.3	0.957
200 x 200	4.0	30.7	Slender	FW	25.1	0.817	Slender	FW	24.7	0.805	Slender	FW	20.3	0.661	Slender	FW	19.3	0.631
	5.0	37.9	Slender	FW	36.4	0.960	Slender	FW	35.9	0.947	Slender	FW	29.9	0.789	Slender	FW	28.6	0.755
	6.0	45.0	Non Slender		45.0	1.00	Non Slender		45.0	1.00	Slender	FW	40.7	0.905	Slender	FW	39.1	0.868
250 x 250	5.0	47.9	Slender	FW	39.2	0.817	Slender	FW	38.6	0.805	Slender	FW	31.7	0.661	Slender	FW	30.2	0.631
	6.0	57.0	Slender	FW	53.2	0.933	Slender	FW	52.4	0.920	Slender	FW	43.6	0.765	Slender	FW	41.7	0.731
	8.0	74.7	Non Slender		74.7	1.00	Non Slender		74.7	1.00	Slender	FW	70.8	0.948	Slender	FW	68.0	0.911

β_c is 1.0 for non slender sections and A_{eff}/A_g for slender sections.

W indicates that the web is slender.

F indicates that the flange is slender.

Only the sections which can be slender under axial compression are given in the table.

Values of A_{eff} in **bold type** are less than the gross area.

For explanation of table see Section 8.3.

Table 10 SQUARE HOLLOW SECTIONS

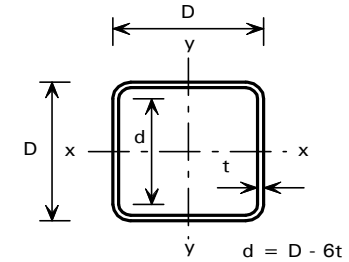

CLASSIFICATION & EFFECTIVE AREA FOR SECTIONS SUBJECT TO AXIAL COMPRESSION

D x D mm	t mm	Gross Area A_g cm ²	1.4301 (304)			1.4401 (316) and 1.4404 (316L)			1.4362 (SAF 2304)			1.4462 (2205)						
			Classification		Effective Area A_{eff} cm ²	β_c	Classification		Effective Area A_{eff} cm ²	β_c	Classification		Effective Area A_{eff} cm ²	β_c				
300 x 300	5.0	57.9	Slender	FW	41.2	0.711	Slender	FW	40.5	0.700	Slender	FW	32.9	0.568	Slender	FW	31.3	0.541
	6.0	69.0	Slender	FW	56.4	0.817	Slender	FW	55.6	0.805	Slender	FW	45.6	0.661	Slender	FW	43.5	0.631
	8.0	90.7	Non Slender		90.7	1.00	Slender	FW	89.7	0.990	Slender	FW	75.2	0.829	Slender	FW	72.0	0.794
	10.0	111	Non Slender		111	1.00	Non Slender		111	1.00	Slender	FW	108	0.975	Slender	FW	104	0.938
350 x 350	6.0	81.0	Slender	FW	58.9	0.727	Slender	FW	58.0	0.715	Slender	FW	47.2	0.582	Slender	FW	44.9	0.554
	8.0	106	Slender	FW	96.1	0.901	Slender	FW	94.8	0.888	Slender	FW	78.5	0.736	Slender	FW	75.0	0.703
	10.0	131	Non Slender		131	1.00	Non Slender		131	1.00	Slender	FW	114	0.873	Slender	FW	110	0.837
	12.0	156	Non Slender		156	1.00	Non Slender		156	1.00	Slender	FW	155	0.994	Slender	FW	149	0.957
400 x 400	6.0	93.0	Slender	FW	60.8	0.654	Slender	FW	59.8	0.643	Slender	FW	48.3	0.520	Slender	FW	45.9	0.494
	8.0	122	Slender	FW	100	0.817	Slender	FW	98.8	0.805	Slender	FW	81.1	0.661	Slender	FW	77.4	0.631
	10.0	151	Slender	FW	145	0.960	Slender	FW	143	0.947	Slender	FW	119	0.789	Slender	FW	114	0.755
	12.0	180	Non Slender		180	1.00	Non Slender		180	1.00	Slender	FW	162	0.905	Slender	FW	156	0.868

β_c is 1.0 for non slender sections and A_{eff}/A_g for slender sections.

W indicates that the web is slender.

F indicates that the flange is slender.

Only the sections which can be slender under axial compression are given in the table.

Values of A_{eff} in **bold type** are less than the gross area.

For explanation of table see Section 8.3.

Table 11 CHANNELS

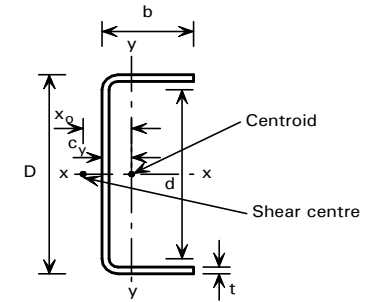

CLASSIFICATION & EFFECTIVE AREA FOR SECTIONS SUBJECT TO AXIAL COMPRESSION

D x b mm	t mm	Gross Area A _g cm ²	1.4301 (304)					1.4401 (316) and 1.4404 (316L)					1.4362 (SAF 2304)					1.4462 (2205)				
			Classification		Effective Area A _{eff} cm ²	β _c	Shift of neutral axis e _y mm	Classification		Effective Area A _{eff} cm ²	β _c	Shift of neutral axis e _y mm	Classification		Effective Area A _{eff} cm ²	β _c	Shift of neutral axis e _y mm	Classification		Effective Area A _{eff} cm ²	β _c	Shift of neutral axis e _y mm
50 x 25	2.0	1.83	Slender	F	1.83	0.998	0.0298	Slender	F	1.82	0.991	0.159	Slender	F	1.65	0.900	1.71	Slender	F	1.61	0.880	2.04
75 x 35	3.0	3.98	Non Slender		3.98	1.000	0	Non Slender		3.98	1.000	0	Slender	F	3.67	0.923	1.87	Slender	F	3.59	0.903	2.34
	4.0	5.14	Non Slender		5.14	1.000	0	Non Slender		5.14	1.000	0	Non Slender		5.14	1.000	0	Slender	F	5.07	0.987	0.312
100 x 50	3.0	5.63	Slender	F	5.13	0.912	3.06	Slender	F	5.10	0.906	3.29	Slender	FW	4.37	0.777	5.50	Slender	FW	4.17	0.741	5.90
	4.0	7.34	Slender	F	7.32	0.998	0.0597	Slender	F	7.27	0.991	0.318	Slender	F	6.60	0.900	3.42	Slender	F	6.46	0.880	4.08
	5.0	8.96	Non Slender		8.96	1.000	0	Non Slender		8.96	1.000	0	Slender	F	8.66	0.967	1.15	Slender	F	8.47	0.945	1.90
125 x 50	3.0	6.38	Slender	FW	5.64	0.885	2.44	Slender	FW	5.56	0.872	2.58	Slender	FW	4.55	0.713	4.30	Slender	FW	4.33	0.679	4.67
	4.0	8.34	Slender	F	8.32	0.999	0.0547	Slender	F	8.27	0.992	0.292	Slender	FW	7.36	0.883	2.85	Slender	FW	7.04	0.844	3.27
	5.0	10.2	Non Slender		10.2	1.000	0	Non Slender		10.2	1.000	0	Slender	F	9.91	0.971	1.05	Slender	F	9.72	0.951	1.73
150 x 60	4.0	10.1	Slender	F	9.62	0.949	2.21	Slender	FW	9.50	0.937	2.40	Slender	FW	7.83	0.773	4.54	Slender	FW	7.47	0.737	5.01
	5.0	12.5	Non Slender		12.5	1.000	0	Non Slender		12.5	1.000	0	Slender	FW	11.3	0.909	3.16	Slender	FW	10.8	0.870	3.67
	6.0	14.7	Non Slender		14.7	1.000	0	Non Slender		14.7	1.000	0	Slender	F	14.3	0.971	1.26	Slender	F	14.0	0.951	2.08
175 x 60	5.0	13.7	Non Slender		13.7	1.000	0	Non Slender		13.7	1.000	0	Slender	FW	11.7	0.853	2.27	Slender	FW	11.2	0.815	2.75
	6.0	16.2	Non Slender		16.2	1.000	0	Non Slender		16.2	1.000	0	Slender	FW	15.7	0.970	1.14	Slender	FW	15.1	0.930	1.65
200 x 75	5.0	16.5	Slender	FW	15.3	0.928	2.35	Slender	FW	15.1	0.915	2.56	Slender	FW	12.4	0.752	5.17	Slender	FW	11.8	0.717	5.74
	6.0	19.5	Slender	F	19.5	0.999	0.0799	Slender	F	19.4	0.992	0.425	Slender	FW	16.8	0.861	3.80	Slender	FW	16.0	0.822	4.42
	8.0	25.3	Non Slender		25.3	1.000	0	Non Slender		25.3	1.000	0	Slender	F	25.1	0.989	0.595	Slender	F	24.6	0.970	1.61

β_c is 1.0 for non slender sections and A_{eff}/A_g for slender sections.

W indicates that the web is slender.

F indicates that the flange is slender.

Only the sections which can be slender under axial compression are given in the table.

Values of A_{eff} in **bold type** are less than the gross area.

For explanation of table see Section 8.3.

Table 11 CHANNELS

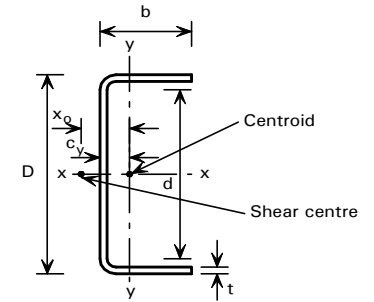

CLASSIFICATION & EFFECTIVE AREA FOR SECTIONS SUBJECT TO AXIAL COMPRESSION

D x b mm	t mm	Gross Area A _g cm ²	1.4301 (304)					1.4401 (316) and 1.4404 (316L)					1.4362 (SAF 2304)					1.4462 (2205)				
			Classification		Effective Area A _{eff} cm ²	β _c	Shift of neutral axis e _y mm	Classification		Effective Area A _{eff} cm ²	β _c	Shift of neutral axis e _y mm	Classification		Effective Area A _{eff} cm ²	β _c	Shift of neutral axis e _y mm	Classification		Effective Area A _{eff} cm ²	β _c	Shift of neutral axis e _y mm
225 x 75	6.0	21.0	Slender	F	21.0	0.999	0.0757	Slender	FW	20.7	0.987	0.310	Slender	FW	17.2	0.818	2.94	Slender	FW	16.4	0.781	3.53
	8.0	27.3	Non Slender		27.3	1.000	0	Non Slender		27.3	1.000	0	Slender	F	27.1	0.990	0.563	Slender	FW	26.3	0.961	1.37
250 x 100	6.0	25.5	Slender	FW	22.6	0.885	4.88	Slender	FW	22.2	0.872	5.17	Slender	FW	18.2	0.713	8.59	Slender	FW	17.3	0.679	9.34
	8.0	33.3	Slender	F	33.3	0.999	0.109	Slender	F	33.1	0.992	0.583	Slender	FW	29.4	0.883	5.70	Slender	FW	28.2	0.844	6.54
	10.0	40.9	Non Slender		40.9	1.000	0	Non Slender		40.9	1.000	0	Slender	F	39.7	0.971	2.11	Slender	F	38.9	0.951	3.46
300 x 100	8.0	37.3	Slender	F	37.3	0.999	0.101	Slender	FW	36.8	0.987	0.413	Slender	FW	30.5	0.818	3.92	Slender	FW	29.2	0.781	4.70
	10.0	45.9	Non Slender		45.9	1.000	0	Non Slender		45.9	1.000	0	Slender	FW	44.0	0.959	1.65	Slender	FW	42.1	0.919	2.49
350 x 125	8.0	45.3	Slender	FW	40.1	0.885	3.91	Slender	FW	39.5	0.872	4.25	Slender	FW	32.3	0.713	8.46	Slender	FW	30.8	0.679	9.39
	10.0	55.9	Slender	F	55.8	0.999	0.130	Slender	F	55.4	0.993	0.693	Slender	FW	47.1	0.843	5.74	Slender	FW	45.0	0.805	6.75
	12.0	66.0	Non Slender		66.0	1.000	0	Non Slender		66.0	1.000	0	Slender	FW	63.3	0.959	3.37	Slender	FW	60.7	0.919	4.43
400 x 150	8.0	53.3	Slender	FW	42.3	0.793	8.26	Slender	FW	41.6	0.780	8.65	Slender	FW	33.7	0.632	13.4	Slender	FW	32.0	0.600	14.5
	10.0	65.9	Slender	FW	61.1	0.928	4.70	Slender	FW	60.2	0.915	5.12	Slender	FW	49.5	0.752	10.3	Slender	FW	47.2	0.717	11.5
	12.0	78.0	Slender	F	77.9	0.999	0.160	Slender	F	77.4	0.992	0.851	Slender	FW	67.1	0.861	7.60	Slender	FW	64.2	0.822	8.83
	15.0	95.7	Non Slender		95.7	1.000	0	Non Slender		95.7	1.000	0	Slender	F	93.0	0.972	3.07	Slender	F	91.2	0.953	5.04

β_c is 1.0 for non slender sections and A_{eff}/A_g for slender sections.

W indicates that the web is slender.

F indicates that the flange is slender.

Only the sections which can be slender under axial compression are given in the table.

Values of A_{eff} in **bold type** are less than the gross area.

For explanation of table see Section 8.3.

Table 12 DOUBLE CHANNELS BACK TO BACK

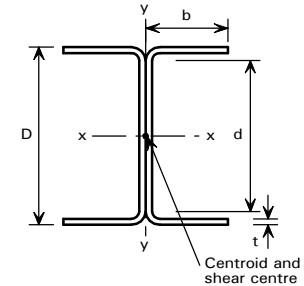

CLASSIFICATION & EFFECTIVE AREA FOR SECTIONS SUBJECT TO AXIAL COMPRESSION

D x 2b mm	t mm	Gross Area A _g cm ²	1.4301 (304)				1.4401 (316) and 1.4404 (316L)				1.4362 (SAF 2304)				1.4462 (2205)			
			Classification		Effective Area A _{eff} cm ²	β _c	Classification		Effective Area A _{eff} cm ²	β _c	Classification		Effective Area A _{eff} cm ²	β _c	Classification		Effective Area A _{eff} cm ²	β _c
50 x 50	2.0	3.67	Slender	F	3.58	0.976	Slender	F	3.56	0.970	Slender	F	3.25	0.885	Slender	F	3.18	0.866
	3.0	5.25	Non Slender		5.25	1.000	Non Slender		5.25	1.000	Non Slender		5.25	1.000	Slender	F	5.15	0.979
75 x 70	3.0	7.95	Slender	F	7.93	0.997	Slender	F	7.87	0.990	Slender	F	7.22	0.907	Slender	F	7.07	0.889
	4.0	10.3	Non Slender		10.3	1.000	Non Slender		10.3	1.000	Slender	F	10.1	0.986	Slender	F	9.93	0.966
100 x 100	3.0	11.3	Slender	F	10.1	0.897	Slender	F	10.0	0.891	Slender	FW	8.63	0.767	Slender	FW	8.24	0.732
	4.0	14.7	Slender	F	14.3	0.976	Slender	F	14.2	0.970	Slender	F	13.0	0.885	Slender	F	12.7	0.866
	5.0	17.9	Non Slender		17.9	1.000	Non Slender		17.9	1.000	Slender	F	17.0	0.947	Slender	F	16.6	0.926
125 x 100	3.0	12.8	Slender	FW	11.1	0.872	Slender	FW	11.0	0.859	Slender	FW	8.99	0.705	Slender	FW	8.56	0.671
	4.0	16.7	Slender	F	16.3	0.979	Slender	F	16.2	0.973	Slender	FW	14.5	0.870	Slender	FW	13.9	0.832
	5.0	20.4	Non Slender		20.4	1.000	Non Slender		20.4	1.000	Slender	F	19.5	0.953	Slender	F	19.1	0.935
	6.0	24.0	Non Slender		24.0	1.000	Non Slender		24.0	1.000	Non Slender		24.0	1.000	Slender	F	23.6	0.982
150 x 120	4.0	20.3	Slender	F	18.9	0.934	Slender	FW	18.7	0.923	Slender	FW	15.5	0.763	Slender	FW	14.8	0.728
	5.0	24.9	Slender	F	24.7	0.990	Slender	F	24.5	0.984	Slender	FW	22.3	0.895	Slender	FW	21.4	0.857
	6.0	29.4	Non Slender		29.4	1.000	Non Slender		29.4	1.000	Slender	F	28.0	0.953	Slender	F	27.5	0.935
175 x 120	5.0	27.4	Slender	F	27.2	0.991	Slender	F	27.0	0.985	Slender	FW	23.1	0.841	Slender	FW	22.0	0.804
	6.0	32.4	Non Slender		32.4	1.000	Non Slender		32.4	1.000	Slender	FW	30.9	0.954	Slender	FW	29.7	0.915

β_c is 1.0 for non slender sections and A_{eff}/A_g for slender sections.

W indicates that the web is slender.

F indicates that the flange is slender.

Only the sections which can be slender under axial compression are given in the table.

Values of A_{eff} in **bold type** are less than the gross area.

For explanation of table see Section 8.3.

Table 12 DOUBLE CHANNELS BACK TO BACK

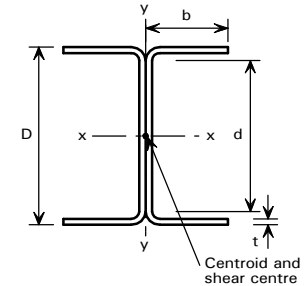

CLASSIFICATION & EFFECTIVE AREA FOR SECTIONS SUBJECT TO AXIAL COMPRESSION

D x 2b mm	t mm	Gross Area A _g cm ²	1.4301 (304)				1.4401 (316) and 1.4404 (316L)				1.4362 (SAF 2304)				1.4462 (2205)			
			Classification		Effective Area A _{eff} cm ²	β _c	Classification		Effective Area A _{eff} cm ²	β _c	Classification		Effective Area A _{eff} cm ²	β _c	Classification		Effective Area A _{eff} cm ²	β _c
200 x 150	5.0	32.9	Slender	FW	30.1	0.913	Slender	FW	29.6	0.900	Slender	FW	24.4	0.742	Slender	FW	23.3	0.708
	6.0	39.0	Slender	F	38.2	0.980	Slender	F	38.0	0.974	Slender	FW	33.1	0.848	Slender	FW	31.6	0.811
	8.0	50.7	Non Slender		50.7	1.000	Non Slender		50.7	1.000	Slender	F	49.2	0.971	Slender	F	48.3	0.953
225 x 150	6.0	42.0	Slender	F	41.2	0.981	Slender	FW	40.7	0.970	Slender	FW	33.9	0.806	Slender	FW	32.4	0.770
	8.0	54.7	Non Slender		54.7	1.000	Non Slender		54.7	1.000	Slender	F	53.2	0.973	Slender	FW	51.7	0.946
250 x 200	6.0	51.0	Slender	FW	44.5	0.872	Slender	FW	43.8	0.859	Slender	FW	36.0	0.705	Slender	FW	34.2	0.671
	8.0	66.7	Slender	F	65.3	0.979	Slender	F	64.9	0.973	Slender	FW	58.0	0.870	Slender	FW	55.5	0.832
	10.0	81.7	Non Slender		81.7	1.000	Non Slender		81.7	1.000	Slender	F	77.9	0.953	Slender	F	76.4	0.935
	12.0	96.1	Non Slender		96.1	1.000	Non Slender		96.1	1.000	Non Slender		96.1	1.000	Slender	F	94.3	0.982
300 x 200	8.0	74.7	Slender	F	73.3	0.981	Slender	FW	72.4	0.970	Slender	FW	60.2	0.806	Slender	FW	57.5	0.770
	10.0	91.7	Non Slender		91.7	1.000	Non Slender		91.7	1.000	Slender	FW	86.5	0.943	Slender	FW	83.0	0.905
	12.0	108	Non Slender		108	1.000	Non Slender		108	1.000	Non Slender		108	1.000	Slender	F	106	0.984
350 x 250	8.0	90.7	Slender	FW	79.0	0.871	Slender	FW	77.9	0.858	Slender	FW	63.9	0.704	Slender	FW	60.8	0.671
	10.0	111	Slender	F	109	0.981	Slender	F	108	0.975	Slender	FW	92.8	0.831	Slender	FW	88.7	0.794
	12.0	132	Non Slender		132	1.000	Non Slender		132	1.000	Slender	FW	124	0.944	Slender	FW	119	0.905
	15.0	161	Non Slender		161	1.000	Non Slender		161	1.000	Non Slender		161	1.000	Slender	F	158	0.983
400 x 300	8.0	106	Slender	FW	83.4	0.782	Slender	FW	82.1	0.770	Slender	FW	66.7	0.625	Slender	FW	63.4	0.594
	10.0	131	Slender	FW	120	0.913	Slender	FW	118	0.900	Slender	FW	97.8	0.742	Slender	FW	93.2	0.708
	12.0	156	Slender	F	152	0.980	Slender	F	152	0.974	Slender	FW	132	0.848	Slender	FW	126	0.811
	15.0	191	Non Slender		191	1.000	Non Slender		191	1.000	Slender	F	182	0.955	Slender	F	179	0.938

β_c is 1.0 for non slender sections and A_{eff}/A_g for slender sections.

W indicates that the web is slender.

F indicates that the flange is slender.

Only the sections which can be slender under axial compression are given in the table.

Values of A_{eff} in **bold type** are less than the gross area.

For explanation of table see Section 8.3.

Table 13 EQUAL ANGLES

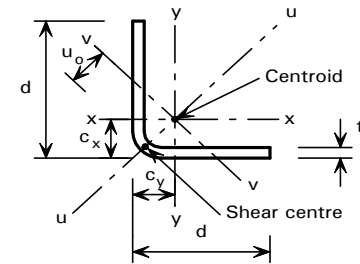

CLASSIFICATION & EFFECTIVE AREA FOR SECTIONS SUBJECT TO AXIAL COMPRESSION

d x d mm	t mm	Gross Area A _g cm ²	1.4301 (304)				1.4401 (316) and 1.4404 (316L)				1.4362 (SAF 2304)				1.4462 (2205)			
			Classification	Effective Area A _{eff} cm ²	β _c	Shift of neutral axis e _x , e _y mm	Classification	Effective Area A _{eff} cm ²	β _c	Shift of neutral axis e _x , e _y mm	Classification	Effective Area A _{eff} cm ²	β _c	Shift of neutral axis e _x , e _y mm	Classification	Effective Area A _{eff} cm ²	β _c	Shift of neutral axis e _x , e _y mm
50 x 50	5.0	4.48	Slender	4.33	0.966	0.372	Slender	4.26	0.951	0.537	Slender	3.44	0.767	2.57	Slender	3.25	0.726	3.02
	6.0	5.25	Non Slender	5.25	1.00	0	Non Slender	5.25	1.00	0	Slender	4.60	0.875	1.34	Slender	4.36	0.830	1.81
75 x 75	6.0	8.25	Slender	6.85	0.830	2.90	Slender	6.74	0.816	3.13	Slender	5.35	0.648	5.98	Slender	5.05	0.612	6.60
	8.0	10.7	Non Slender	10.7	1.00	0	Slender	10.6	0.993	0.114	Slender	8.58	0.804	3.22	Slender	8.13	0.762	3.90
	10.0	12.9	Non Slender	12.9	1.00	0	Non Slender	12.9	1.00	0	Slender	12.2	0.942	0.913	Slender	11.6	0.896	1.64
100 x 100	8.0	14.7	Slender	12.2	0.830	3.86	Slender	12.0	0.816	4.17	Slender	9.51	0.648	7.97	Slender	8.97	0.612	8.79
	10.0	17.9	Slender	17.3	0.966	0.743	Slender	17.1	0.951	1.07	Slender	13.7	0.767	5.15	Slender	13.0	0.726	6.04
	12.0	21.0	Non Slender	21.0	1.00	0	Non Slender	21.0	1.00	0	Slender	18.4	0.875	2.68	Slender	17.5	0.830	3.63
	15.0	25.3	Non Slender	25.3	1.00	0	Non Slender	25.3	1.00	0	Non Slender	25.3	1.00	0	Slender	24.7	0.974	0.541
120 x 120	8.0	17.9	Slender	13.0	0.728	7.53	Slender	12.8	0.716	7.88	Slender	10.0	0.562	12.1	Slender	9.46	0.529	13.0
	10.0	21.9	Slender	18.7	0.854	3.96	Slender	18.4	0.840	4.34	Slender	14.7	0.669	8.97	Slender	13.8	0.631	9.97
	12.0	25.8	Slender	24.9	0.966	0.892	Slender	24.6	0.951	1.29	Slender	19.8	0.767	6.17	Slender	18.7	0.726	7.25
	15.0	31.3	Non Slender	31.3	1.00	0	Non Slender	31.3	1.00	0	Slender	28.2	0.900	2.54	Slender	26.8	0.855	3.69
150 x 150	8.0	22.7	Slender	14.0	0.616	13.5	Slender	13.7	0.605	13.9	Slender	10.6	0.469	18.7	Slender	9.99	0.440	19.7
	10.0	27.9	Slender	20.3	0.728	9.41	Slender	20.0	0.716	9.85	Slender	15.7	0.562	15.2	Slender	14.8	0.529	16.3
	12.0	33.0	Slender	27.4	0.830	5.79	Slender	26.9	0.816	6.26	Slender	21.4	0.648	12.0	Slender	20.2	0.612	13.2
	15.0	40.3	Slender	39.0	0.966	1.11	Slender	38.4	0.951	1.61	Slender	30.9	0.767	7.72	Slender	29.3	0.726	9.06
200 x 200	8.0	30.7	Slender	15.1	0.491	24.3	Slender	14.8	0.481	24.8	Slender	11.3	0.368	30.1	Slender	10.6	0.345	31.3
	10.0	37.9	Slender	22.2	0.586	19.5	Slender	21.8	0.575	20.0	Slender	16.9	0.445	26.2	Slender	15.8	0.417	27.4
	12.0	45.0	Slender	30.3	0.674	15.2	Slender	29.8	0.662	15.8	Slender	23.2	0.516	22.5	Slender	21.9	0.486	23.9
	15.0	55.3	Slender	43.9	0.793	9.46	Slender	43.1	0.780	10.1	Slender	34.1	0.616	17.5	Slender	32.2	0.581	19.1

β_c is 1.0 for non slender sections and A_{eff}/A_g for slender sections.

Only the sections which can be slender under axial compression are given in the table.

Values of A_{eff} in **bold type** are less than the gross area.

For explanation of table see Section 8.3.

Table 14 DOUBLE ANGLES BACK TO BACK

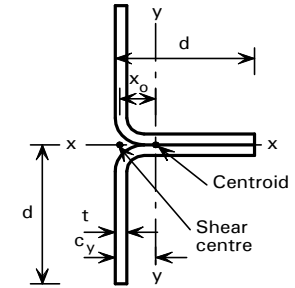

CLASSIFICATION & EFFECTIVE AREA FOR SECTIONS SUBJECT TO AXIAL COMPRESSION

2d x d mm	t mm	Gross Area A_g cm ²	1.4301 (304)				1.4401 (316) and 1.4404 (316L)				1.4362 (SAF 2304)				1.4462 (2205)			
			Classification	Effective Area A_{eff} cm ²	β_c	Shift of neutral axis e_y mm	Classification	Effective Area A_{eff} cm ²	β_c	Shift of neutral axis e_y mm	Classification	Effective Area A_{eff} cm ²	β_c	Shift of neutral axis e_y mm	Classification	Effective Area A_{eff} cm ²	β_c	Shift of neutral axis e_y mm
100 x 50	5.0	8.96	Slender	8.66	0.966	0.372	Slender	8.53	0.951	0.537	Slender	6.87	0.767	2.57	Slender	6.51	0.726	3.02
	6.0	10.5	Non Slender	10.5	1.00	0	Non Slender	10.5	1.00	0	Slender	9.19	0.875	1.34	Slender	8.73	0.830	1.81
150 x 75	6.0	16.5	Slender	13.7	0.830	2.90	Slender	13.5	0.816	3.13	Slender	10.7	0.648	5.98	Slender	10.1	0.612	6.60
	8.0	21.3	Non Slender	21.3	1.00	0	Slender	21.2	0.993	0.114	Slender	17.2	0.804	3.22	Slender	16.3	0.762	3.90
	10.0	25.9	Non Slender	25.9	1.00	0	Non Slender	25.9	1.00	0	Slender	24.4	0.942	0.913	Slender	23.2	0.896	1.64
200 x 100	8.0	29.3	Slender	24.4	0.830	3.86	Slender	24.0	0.816	4.17	Slender	19.0	0.648	7.97	Slender	17.9	0.612	8.79
	10.0	35.9	Slender	34.6	0.966	0.743	Slender	34.1	0.951	1.07	Slender	27.5	0.767	5.15	Slender	26.0	0.726	6.04
	12.0	42.0	Non Slender	42.0	1.00	0	Non Slender	42.0	1.00	0	Slender	36.8	0.875	2.68	Slender	34.9	0.830	3.63
	15.0	50.7	Non Slender	50.7	1.00	0	Non Slender	50.7	1.00	0	Non Slender	50.7	1.00	0	Slender	49.3	0.974	0.541
240 x 120	8.0	35.7	Slender	26.0	0.728	7.53	Slender	25.6	0.716	7.88	Slender	20.1	0.562	12.1	Slender	18.9	0.529	13.0
	10.0	43.9	Slender	37.5	0.854	3.96	Slender	36.8	0.840	4.34	Slender	29.3	0.669	8.97	Slender	27.7	0.631	9.97
	12.0	51.6	Slender	49.9	0.966	0.892	Slender	49.1	0.951	1.29	Slender	39.6	0.767	6.17	Slender	37.5	0.726	7.25
	15.0	62.7	Non Slender	62.7	1.00	0	Non Slender	62.7	1.00	0	Slender	56.4	0.900	2.54	Slender	53.6	0.855	3.69
300 x 150	8.0	45.3	Slender	27.9	0.616	13.5	Slender	27.4	0.605	13.9	Slender	21.3	0.469	18.7	Slender	20.0	0.440	19.7
	10.0	55.9	Slender	40.7	0.728	9.41	Slender	40.0	0.716	9.85	Slender	31.4	0.562	15.2	Slender	29.5	0.529	16.3
	12.0	66.0	Slender	54.8	0.830	5.79	Slender	53.9	0.816	6.26	Slender	42.8	0.648	12.0	Slender	40.4	0.612	13.2
	15.0	80.7	Slender	78.0	0.966	1.11	Slender	76.8	0.951	1.61	Slender	61.8	0.767	7.72	Slender	58.5	0.726	9.06
400 x 200	8.0	61.3	Slender	30.1	0.491	24.3	Slender	29.5	0.481	24.8	Slender	22.6	0.368	30.1	Slender	21.1	0.345	31.3
	10.0	75.9	Slender	44.5	0.586	19.5	Slender	43.6	0.575	20.0	Slender	33.7	0.445	26.2	Slender	31.6	0.417	27.4
	12.0	90.0	Slender	60.7	0.674	15.2	Slender	59.6	0.662	15.8	Slender	46.5	0.516	22.5	Slender	43.7	0.486	23.9
	15.0	110	Slender	87.8	0.793	9.46	Slender	86.3	0.780	10.1	Slender	68.2	0.616	17.5	Slender	64.3	0.581	19.1

β_c is 1.0 for non slender sections and A_{eff}/A_g for slender sections.

Only the sections which can be slender under axial compression are given in the table.

Values of A_{eff} in **bold type** are less than the gross area.

For explanation of table see Section 8.3.

Table 15 CIRCULAR HOLLOW SECTIONS

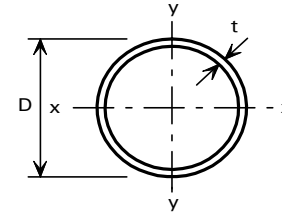

CLASSIFICATION FOR SECTIONS SUBJECT TO PURE BENDING AXIS X-X

D mm	t mm	1.4301 (304)	1.4401 (316) and 1.4404 (316L)	1.4362 (SAF 2304)	1.4462 (2205)
42.4	1.0	Plastic	Plastic	Semi-compact	Semi-compact
48.3	1.0	Plastic	Plastic	Semi-compact	Semi-compact
60.3	1.0	Compact	Compact	Semi-compact	Semi-compact
	1.6	Plastic	Plastic	Compact	Semi-compact
76.1	1.0	Semi-compact	Semi-compact	Semi-compact	Semi-compact
	1.6	Plastic	Plastic	Semi-compact	Semi-compact
	2.0	Plastic	Plastic	Compact	Semi-compact
88.9	1.0	Semi-compact	Semi-compact	Semi-compact	Semi-compact
	1.6	Compact	Compact	Semi-compact	Semi-compact
	2.0	Plastic	Plastic	Semi-compact	Semi-compact
	2.6	Plastic	Plastic	Compact	Semi-compact
101.6	1.0	Semi-compact	Semi-compact	Semi-compact	Semi-compact
	1.6	Compact	Compact	Semi-compact	Semi-compact
	2.0	Plastic	Compact	Semi-compact	Semi-compact
	2.6	Plastic	Plastic	Semi-compact	Semi-compact
114.3	1.2	Semi-compact	Semi-compact	Semi-compact	Semi-compact
	1.6	Compact	Semi-compact	Semi-compact	Semi-compact
	2.0	Compact	Compact	Semi-compact	Semi-compact
	2.6	Plastic	Plastic	Semi-compact	Semi-compact
	3.2	Plastic	Plastic	Compact	Semi-compact

D mm	t mm	1.4301 (304)	1.4401 (316) and 1.4404 (316L)	1.4362 (SAF 2304)	1.4462 (2205)
139.7	1.2	Semi-compact	Semi-compact	Semi-compact	Semi-compact
	1.6	Semi-compact	Semi-compact	Semi-compact	Semi-compact
	2.0	Compact	Compact	Semi-compact	Semi-compact
	2.6	Compact	Compact	Semi-compact	Semi-compact
	3.2	Plastic	Plastic	Semi-compact	Semi-compact
168.3	4.0	Plastic	Plastic	Compact	Semi-compact
	1.6	Semi-compact	Semi-compact	Semi-compact	Semi-compact
	2.0	Semi-compact	Semi-compact	Semi-compact	Semi-compact
	2.6	Compact	Compact	Semi-compact	Semi-compact
	3.2	Compact	Compact	Semi-compact	Semi-compact
219.1	4.0	Plastic	Plastic	Semi-compact	Semi-compact
	2.0	Semi-compact	Semi-compact	Semi-compact	Semi-compact
	2.6	Semi-compact	Semi-compact	Semi-compact	Semi-compact
	3.2	Compact	Compact	Semi-compact	Semi-compact
	4.0	Compact	Compact	Semi-compact	Semi-compact
273	5.0	Plastic	Plastic	Semi-compact	Semi-compact
	2.6	Semi-compact	Semi-compact	Semi-compact	Semi-compact
	3.2	Semi-compact	Semi-compact	Semi-compact	Semi-compact
	4.0	Compact	Compact	Semi-compact	Semi-compact
	5.0	Compact	Compact	Semi-compact	Semi-compact

Only the sections which can be semi compact or slender under pure bending are given in the table.

No guidance is available on the calculation of effective section properties for slender stainless steel circular hollow sections.

For explanation of table see Section 8.3.

Table 16 RECTANGULAR HOLLOW SECTIONS

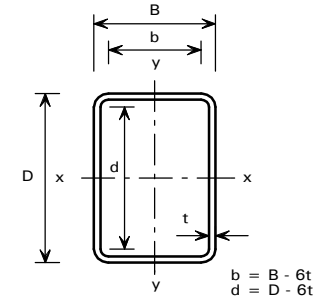

CLASSIFICATION & EFFECTIVE SECTION PROPERTIES FOR SECTIONS SUBJECT TO PURE BENDING AXIS X-X

D x B mm	t mm	1.4301 (304)					1.4401 (316) and 1.4404 (316L)					1.4362 (SAF 2304)					1.4462 (2205)				
		Classification		Properties			Classification		Properties			Classification		Properties			Classification		Properties		
				$I_{x,eff}$ cm ⁴	$Z_{x,eff}$ cm ³	β_w			$I_{x,eff}$ cm ⁴	$Z_{x,eff}$ cm ³	β_w			$I_{x,eff}$ cm ⁴	$Z_{x,eff}$ cm ³	β_w			$I_{x,eff}$ cm ⁴	$Z_{x,eff}$ cm ³	β_w
100 x 50	2.0	Plastic		-	-	1.00	Plastic		-	-	1.00	Compact		-	-	1.00	Semi-compact		-	-	0.807
150 x 75	3.0	Plastic		-	-	1.00	Plastic		-	-	1.00	Compact		-	-	1.00	Semi-compact		-	-	0.807
150 x 100	3.0	Compact		-	-	1.00	Compact		-	-	1.00	Slender	F	437.1	57.21	0.791	Slender	F	431.3	56.05	0.775
200 x 100	4.0	Plastic		-	-	1.00	Plastic		-	-	1.00	Compact		-	-	1.00	Semi-compact		-	-	0.807
200 x 125	4.0	Plastic		-	-	1.00	Plastic		-	-	1.00	Slender	F	1340	132.7	0.805	Slender	F	1323	130.1	0.789
300 x 150	6.0	Plastic		-	-	1.00	Plastic		-	-	1.00	Compact		-	-	1.00	Semi-compact		-	-	0.807
300 x 200	6.0	Compact		-	-	1.00	Compact		-	-	1.00	Slender	F	6993	457.7	0.791	Slender	F	6901	448.4	0.775
350 x 175	6.0	Plastic		-	-	1.00	Plastic		-	-	1.00	Slender	F	9587	547.4	0.809	Slender	F	9478	537.9	0.795
350 x 200	6.0	Compact		-	-	1.00	Compact		-	-	1.00	Slender	F	10170	571.3	0.784	Slender	F	10040	560.6	0.769
400 x 200	6.0	Compact		-	-	1.00	Semi-compact		-	-	0.814	Slender	FW	13920	676.9	0.758	Slender	FW	13570	649.4	0.727
	8.0	Plastic		-	-	1.00	Plastic		-	-	1.00	Compact		-	-	1.00	Semi-compact		-	-	0.807
400 x 250	6.0	Slender	F	16490	814.2	0.805	Slender	F	16420	808.6	0.799	Slender	FW	15210	715.5	0.707	Slender	FW	14810	684.8	0.677
	8.0	Plastic		-	-	1.00	Plastic		-	-	1.00	Slender	F	21450	1061	0.805	Slender	F	21170	1041	0.789

β_w is 1.0 for plastic and compact sections, Z_x/S_x for semi-compact sections and $Z_{x,eff}/S_x$ for slender sections.

W indicates that the web is slender.

F indicates that the flange is slender.

Only the sections which can be semi-compact or slender when subject to pure bending are given in the table.

Effective section properties are only applicable to slender cross-sections; gross properties should be used for plastic, compact and semi-compact cross-sections.

For explanation of table see Section 8.3.

Table 17 SQUARE HOLLOW SECTIONS

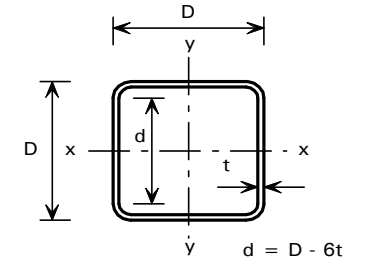

CLASSIFICATION & EFFECTIVE SECTION PROPERTIES FOR SECTIONS SUBJECT TO PURE BENDING AXIS X-X

D x D mm	t mm	1.4301 (304)					1.4401 (316) and 1.4404 (316L)					1.4362 (SAF 2304)					1.4462 (2205)				
		Classification		Properties			Classification		Properties			Classification		Properties			Classification		Properties		
				$I_{x\text{ eff}}$ cm ⁴	$Z_{x\text{ eff}}$ cm ³	β_w			$I_{x\text{ eff}}$ cm ⁴	$Z_{x\text{ eff}}$ cm ³	β_w			$I_{x\text{ eff}}$ cm ⁴	$Z_{x\text{ eff}}$ cm ³	β_w			$I_{x\text{ eff}}$ cm ⁴	$Z_{x\text{ eff}}$ cm ³	β_w
60 x 60	2.0	Plastic		-	-	1.00	Plastic		-	-	1.00	Slender	F	24.28	8.045	0.840	Slender	F	23.92	7.854	0.820
80 x 80	2.0	Slender	F	59.64	14.76	0.840	Slender	F	59.33	14.64	0.833	Slender	F	55.45	13.15	0.748	Slender	F	54.57	12.83	0.730
	3.0	Plastic		-	-	1.00	Plastic		-	-	1.00	Semi-compact		-	-	0.848	Semi-compact		-	-	0.848
100 x 100	3.0	Compact		-	-	1.00	Compact		-	-	1.00	Slender	F	166.7	32.56	0.805	Slender	F	164.1	31.78	0.786
125 x 125	3.0	Slender	F	339.3	53.40	0.827	Slender	F	337.5	52.95	0.820	Slender	F	315.2	47.54	0.736	Slender	F	310.2	46.37	0.718
	4.0	Plastic		-	-	1.00	Plastic		-	-	1.00	Slender	F	437.3	69.08	0.826	Slender	F	430.7	67.42	0.807
150 x 150	3.0	Slender	F	569.3	72.51	0.768	Slender	F	566.2	71.89	0.762	Slender	F	527.7	64.51	0.684	Slender	F	519.1	62.94	0.667
	4.0	Semi-compact		-	-	0.860	Slender	F	789.0	104.9	0.855	Slender	F	738.2	94.34	0.768	Slender	F	726.6	92.02	0.749
	5.0	Plastic		-	-	1.00	Plastic		-	-	1.00	Slender	F	948.4	125.7	0.840	Slender	F	934.4	122.7	0.820
175 x 175	4.0	Slender	F	1232	137.4	0.811	Slender	F	1225	136.3	0.804	Slender	F	1144	122.3	0.722	Slender	F	1125	119.3	0.704
	5.0	Semi-compact		-	-	0.858	Semi-compact		-	-	0.858	Slender	F	1479	163.9	0.790	Slender	F	1456	159.9	0.771
	6.0	Plastic		-	-	1.00	Plastic		-	-	1.00	Slender	F	1812	206.8	0.849	Slender	F	1785	201.9	0.829
200 x 200	4.0	Slender	F	1799	171.9	0.768	Slender	F	1789	170.4	0.762	Slender	F	1667	152.9	0.684	Slender	F	1640	149.2	0.667
	5.0	Slender	F	2329	230.7	0.840	Slender	F	2317	228.8	0.833	Slender	F	2166	205.5	0.748	Slender	F	2131	200.4	0.730
	6.0	Compact		-	-	1.00	Compact		-	-	1.00	Slender	F	2666	260.5	0.805	Slender	F	2625	254.2	0.786
250 x 250	5.0	Slender	F	4393	335.7	0.768	Slender	F	4369	332.8	0.762	Slender	F	4071	298.7	0.684	Slender	F	4005	291.4	0.667
	6.0	Slender	F	5428	427.2	0.827	Slender	F	5400	423.6	0.820	Slender	F	5043	380.3	0.736	Slender	F	4962	371.0	0.718
	8.0	Plastic		-	-	1.00	Plastic		-	-	1.00	Slender	F	6996	552.6	0.826	Slender	F	6891	539.4	0.807

β_w is 1.0 for plastic and compact sections, Z_x/S_x for semi-compact sections and $Z_{x\text{ eff}}/S_x$ for slender sections.

W indicates that the web is slender.

F indicates that the flange is slender.

Only the sections which can be semi-compact or slender when subject to pure bending are given in the table.

Effective section properties are only applicable to slender cross-sections; gross properties should be used for plastic, compact and semi-compact cross-sections.

For explanation of table see Section 8.3.

Table 17 SQUARE HOLLOW SECTIONS

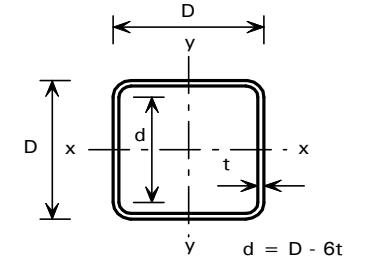

CLASSIFICATION & EFFECTIVE SECTION PROPERTIES FOR SECTIONS SUBJECT TO PURE BENDING AXIS X-X

D x D mm	t mm	1.4301 (304)						1.4401 (316) and 1.4404 (316L)						1.4362 (SAF 2304)						1.4462 (2205)					
		Classification		Properties				Classification		Properties				Classification		Properties				Classification		Properties			
				$I_{x\text{ eff}}$ cm ⁴	$Z_{x\text{ eff}}$ cm ³	β_w	$I_{x\text{ eff}}$ cm ⁴			$Z_{x\text{ eff}}$ cm ³	β_w	$I_{x\text{ eff}}$ cm ⁴	$Z_{x\text{ eff}}$ cm ³			β_w	$I_{x\text{ eff}}$ cm ⁴	$Z_{x\text{ eff}}$ cm ³	β_w						
300 x 300	5.0	Slender	F	7337	454.4	0.714	Slender	F	7296	450.5	0.708	Slender	F	6794	404.8	0.636	Slender	FW	6517	378.1	0.594				
	6.0	Slender	F	9109	580.1	0.768	Slender	F	9059	575.1	0.762	Slender	F	8443	516.1	0.684	Slender	F	8305	503.5	0.667				
	8.0	Semi-compact		-	-	0.860	Slender	F	12620	839.4	0.855	Slender	F	11810	754.7	0.768	Slender	F	11630	736.2	0.749				
	10.0	Plastic		-	-	1.00	Plastic		-	-	1.00	Slender	F	15170	1005	0.840	Slender	F	14950	981.7	0.820				
350 x 350	6.0	Slender	F	14060	749.4	0.722	Slender	F	13980	743.0	0.716	Slender	F	13020	667.4	0.643	Slender	F	12810	651.6	0.628				
	8.0	Slender	F	19720	1099	0.811	Slender	F	19610	1090	0.804	Slender	F	18300	978.4	0.722	Slender	F	18010	954.4	0.704				
	10.0	Semi-compact		-	-	0.858	Semi-compact		-	-	0.858	Slender	F	23670	1310	0.790	Slender	F	23310	1279	0.771				
	12.0	Plastic		-	-	1.00	Plastic		-	-	1.00	Slender	F	28990	1654	0.849	Slender	F	28570	1615	0.829				
400 x 400	6.0	Slender	F	20440	934.6	0.684	Slender	F	20320	926.7	0.678	Slender	FW	18280	785.1	0.575	Slender	FW	17720	748.0	0.547				
	8.0	Slender	F	28790	1375	0.768	Slender	F	28630	1363	0.762	Slender	F	26680	1223	0.684	Slender	F	26250	1193	0.667				
	10.0	Slender	F	37280	1845	0.840	Slender	F	37080	1830	0.833	Slender	F	34660	1643	0.748	Slender	F	34110	1603	0.730				
	12.0	Compact		-	-	1.00	Compact		-	-	1.00	Slender	F	42670	2084	0.805	Slender	F	42010	2033	0.786				
	15.0	Plastic		-	-	1.00	Plastic		-	-	1.00	Semi-compact		-	-	0.848	Semi-compact		-	-	0.848				

β_w is 1.0 for plastic and compact sections, Z_x/S_x for semi-compact sections and $Z_{x\text{ eff}}/S_x$ for slender sections.

W indicates that the web is slender.

F indicates that the flange is slender.

Only the sections which can be semi-compact or slender when subject to pure bending are given in the table.

Effective section properties are only applicable to slender cross-sections; gross properties should be used for plastic, compact and semi-compact cross-sections.

For explanation of table see Section 8.3.

Table 18 CHANNELS

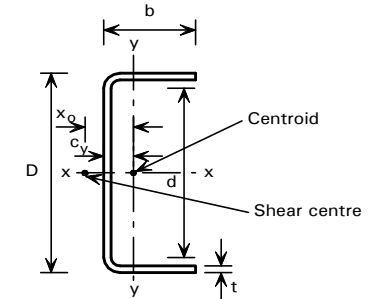

CLASSIFICATION & EFFECTIVE SECTION PROPERTIES FOR SECTIONS SUBJECT TO PURE BENDING AXIS X-X

D x b mm	t mm	1.4301 (304)						1.4401 (316) and 1.4404 (316L)						1.4362 (SAF 2304)						1.4462 (2205)					
		Classification		Properties				Classification		Properties				Classification		Properties				Classification		Properties			
				$I_{x\text{ eff}}$ cm ⁴	$Z_{x\text{ eff}}$ cm ³	β_w	$I_{x\text{ eff}}$ cm ⁴			$Z_{x\text{ eff}}$ cm ³	β_w	$I_{x\text{ eff}}$ cm ⁴	$Z_{x\text{ eff}}$ cm ³			β_w	$I_{x\text{ eff}}$ cm ⁴	$Z_{x\text{ eff}}$ cm ³	β_w			$I_{x\text{ eff}}$ cm ⁴	$Z_{x\text{ eff}}$ cm ³	β_w	
50 x 25	2.0	Slender	F	6.846	2.736	0.843	Slender	F	6.807	2.711	0.836	Slender	F	6.299	2.398	0.739	Slender	F	6.179	2.329	0.718				
	3.0	Plastic		-	-	1.00	Plastic		-	-	1.00	Semi-compact		-	-	0.822	Semi-compact		-	-	0.822				
75 x 35	3.0	Semi-compact		-	-	0.839	Semi-compact		-	-	0.839	Slender	F	30.69	7.881	0.757	Slender	F	30.13	7.659	0.736				
	4.0	Plastic		-	-	1.00	Plastic		-	-	1.00	Semi-compact		-	-	0.823	Slender	F	40.18	10.65	0.810				
100 x 50	3.0	Slender	F	80.48	15.41	0.762	Slender	F	80.00	15.27	0.755	Slender	F	73.80	13.50	0.668	Slender	F	72.38	13.11	0.649				
	4.0	Slender	F	109.5	21.89	0.843	Slender	F	108.9	21.69	0.836	Slender	F	100.8	19.19	0.739	Slender	F	98.87	18.63	0.718				
	5.0	Compact		-	-	1.00	Compact		-	-	1.00	Slender	F	126.6	24.92	0.799	Slender	F	124.3	24.21	0.776				
125 x 50	3.0	Slender	F	136.7	21.05	0.759	Slender	F	136.0	20.87	0.753	Slender	F	126.3	18.68	0.674	Slender	F	124.1	18.20	0.657				
	4.0	Slender	F	186.3	29.79	0.833	Slender	F	185.3	29.54	0.826	Slender	F	172.5	26.43	0.739	Slender	F	169.5	25.73	0.720				
	5.0	Compact		-	-	1.00	Compact		-	-	1.00	Slender	F	217.3	34.27	0.794	Slender	F	213.6	33.37	0.773				
	6.0	Plastic		-	-	1.00	Plastic		-	-	1.00	Semi-compact		-	-	0.815	Semi-compact		-	-	0.815				
150 x 60	4.0	Slender	F	318.1	41.37	0.786	Slender	F	316.4	41.02	0.779	Slender	F	294.0	36.69	0.697	Slender	F	288.9	35.74	0.679				
	5.0	Semi-compact		-	-	0.833	Semi-compact		-	-	0.833	Slender	F	373.4	47.92	0.749	Slender	F	367.0	46.66	0.729				
	6.0	Compact		-	-	1.00	Compact		-	-	1.00	Slender	F	450.5	59.22	0.794	Slender	F	442.9	57.67	0.773				
	8.0	Plastic		-	-	1.00	Plastic		-	-	1.00	Compact		-	-	1.00	Semi-compact		-	-	0.808				
175 x 60	5.0	Semi-compact		-	-	0.825	Semi-compact		-	-	0.825	Slender	F	543.8	60.01	0.747	Slender	F	535.0	58.55	0.729				
	6.0	Compact		-	-	1.00	Compact		-	-	1.00	Slender	F	656.6	74.08	0.788	Slender	F	646.1	72.27	0.769				
	8.0	Plastic		-	-	1.00	Plastic		-	-	1.00	Compact		-	-	1.00	Semi-compact		-	-	0.803				
200 x 75	5.0	Slender	F	906.6	88.51	0.784	Slender	F	901.7	87.77	0.777	Slender	F	839.8	78.78	0.698	Slender	F	825.6	76.82	0.680				
	6.0	Slender	F	1101	110.1	0.830	Slender	F	1095	109.2	0.823	Slender	F	1021	97.96	0.739	Slender	F	1004	95.48	0.720				

β_w is 1.0 for plastic and compact sections, Z_x/S_x for semi-compact sections and $Z_{x\text{ eff}}/S_x$ for slender sections.

W indicates that the web is slender.

F indicates that the flange is slender.

Only the sections which can be semi-compact or slender when subject to pure bending are given in the table.

Effective section properties are only applicable to slender cross-sections; gross properties should be used for plastic, compact and semi-compact cross-sections.

For explanation of table see Section 8.3.

Table 18 CHANNELS

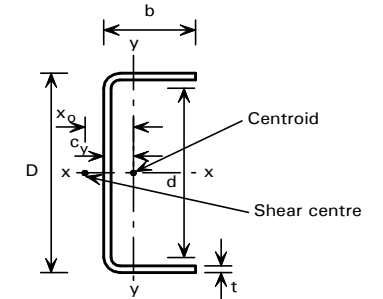

CLASSIFICATION & EFFECTIVE SECTION PROPERTIES FOR SECTIONS SUBJECT TO PURE BENDING AXIS X-X

D x b mm	t mm	1.4301 (304)					1.4401 (316) and 1.4404 (316L)					1.4362 (SAF 2304)					1.4462 (2205)				
		Classification		Properties			Classification		Properties			Classification		Properties			Classification		Properties		
				$I_{x\text{ eff}}$ cm ⁴	$Z_{x\text{ eff}}$ cm ³	β_w			$I_{x\text{ eff}}$ cm ⁴	$Z_{x\text{ eff}}$ cm ³	β_w			$I_{x\text{ eff}}$ cm ⁴	$Z_{x\text{ eff}}$ cm ³	β_w			$I_{x\text{ eff}}$ cm ⁴	$Z_{x\text{ eff}}$ cm ³	β_w
200 x 75	8.0	Plastic		-	-	1.00	Plastic		-	-	1.00	Slender	F	1373	136.6	0.807	Slender	F	1350	133.1	0.787
	10.0	Plastic		-	-	1.00	Plastic		-	-	1.00	Compact		-	-	1.00	Semi-compact		-	-	0.806
225 x 75	6.0	Slender	F	1463	130.0	0.823	Slender	F	1456	129.0	0.817	Slender	F	1362	116.5	0.738	Slender	F	1340	113.7	0.720
	8.0	Plastic		-	-	1.00	Plastic		-	-	1.00	Slender	F	1833	162.2	0.802	Slender	F	1804	158.3	0.783
	10.0	Plastic		-	-	1.00	Plastic		-	-	1.00	Compact		-	-	1.00	Semi-compact		-	-	0.801
250 x 100	6.0	Slender	F	2187	168.4	0.759	Slender	F	2175	166.9	0.753	Slender	F	2021	149.4	0.674	Slender	F	1986	145.6	0.657
	8.0	Slender	F	2981	238.3	0.833	Slender	F	2965	236.3	0.826	Slender	F	2760	211.4	0.739	Slender	F	2712	205.9	0.720
	10.0	Compact		-	-	1.00	Compact		-	-	1.00	Slender	F	3476	274.2	0.794	Slender	F	3417	267.0	0.773
	12.0	Plastic		-	-	1.00	Plastic		-	-	1.00	Semi-compact		-	-	0.815	Semi-compact		-	-	0.815
300 x 100	8.0	Slender	F	4626	308.2	0.823	Slender	F	4603	305.8	0.817	Slender	F	4306	276.1	0.738	Slender	F	4237	269.5	0.720
	10.0	Compact		-	-	1.00	Compact		-	-	1.00	Slender	F	5429	357.4	0.787	Slender	F	5343	348.8	0.768
	12.0	Plastic		-	-	1.00	Plastic		-	-	1.00	Semi-compact		-	-	0.807	Semi-compact		-	-	0.807
350 x 125	8.0	Slender	F	7525	418.0	0.772	Slender	F	7485	414.6	0.766	Slender	F	6980	373.2	0.690	Slender	F	6865	364.2	0.673
	10.0	Slender	F	9557	545.8	0.827	Slender	F	9509	541.4	0.821	Slender	F	8878	487.1	0.738	Slender	F	8731	475.0	0.720
	12.0	Compact		-	-	1.00	Compact		-	-	1.00	Slender	F	10740	602.3	0.780	Slender	F	10560	587.3	0.761
	15.0	Plastic		-	-	1.00	Plastic		-	-	1.00	Semi-compact		-	-	0.810	Semi-compact		-	-	0.810
400 x 150	8.0	Slender	F	11340	538.8	0.730	Slender	F	11280	534.3	0.724	Slender	F	10510	480.6	0.651	Slender	F	10330	469.1	0.636
	10.0	Slender	F	14510	708.1	0.784	Slender	F	14430	702.2	0.777	Slender	F	13440	630.3	0.698	Slender	F	13210	614.5	0.680
	12.0	Slender	F	17620	880.4	0.830	Slender	F	17530	873.2	0.823	Slender	F	16350	783.7	0.739	Slender	F	16070	763.8	0.720
	15.0	Compact		-	-	1.00	Compact		-	-	1.00	Slender	F	20600	1015	0.792	Slender	F	20250	990.0	0.771

β_w is 1.0 for plastic and compact sections, Z_x/S_x for semi-compact sections and $Z_{x\text{ eff}}/S_x$ for slender sections.

W indicates that the web is slender.

F indicates that the flange is slender.

Only the sections which can be semi-compact or slender when subject to pure bending are given in the table.

Effective section properties are only applicable to slender cross-sections; gross properties should be used for plastic, compact and semi-compact cross-sections.

For explanation of table see Section 8.3.

Table 19 DOUBLE CHANNELS BACK TO BACK

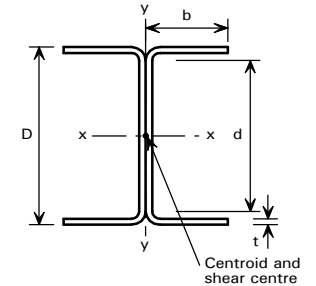

CLASSIFICATION & EFFECTIVE SECTION PROPERTIES FOR SECTIONS SUBJECT TO PURE BENDING AXIS X-X

D x 2b mm	t mm	1.4301 (304)						1.4401 (316) and 1.4404 (316L)						1.4362 (SAF 2304)						1.4462 (2205)					
		Classification		Properties				Classification		Properties				Classification		Properties				Classification		Properties			
				$I_{x\text{ eff}}$ cm ⁴	$Z_{x\text{ eff}}$ cm ³	β_w	$I_{x\text{ eff}}$ cm ⁴			$Z_{x\text{ eff}}$ cm ³	β_w	$I_{x\text{ eff}}$ cm ⁴	$Z_{x\text{ eff}}$ cm ³			β_w	$I_{x\text{ eff}}$ cm ⁴	$Z_{x\text{ eff}}$ cm ³	β_w						
50 x 50	2.0	Slender	F	13.46	5.322	0.820	Slender	F	13.38	5.276	0.813	Slender	F	12.42	4.695	0.724	Slender	F	12.20	4.565	0.704				
	3.0	Compact		-	-	1.00	Compact		-	-	1.00	Semi-compact		-	-	0.822	Slender	F	18.17	7.199	0.800				
75 x 70	3.0	Slender	F	65.34	17.40	0.836	Slender	F	65.00	17.25	0.829	Slender	F	60.50	15.41	0.740	Slender	F	59.43	15.00	0.721				
	4.0	Compact		-	-	1.00	Compact		-	-	1.00	Slender	F	80.30	21.28	0.809	Slender	F	78.96	20.72	0.788				
	5.0	Compact		-	-	1.00	Compact		-	-	1.00	Semi-compact		-	-	0.807	Semi-compact		-	-	0.807				
100 x 100	3.0	Slender	F	158.8	30.16	0.746	Slender	F	157.8	29.89	0.739	Slender	F	146.0	26.57	0.657	Slender	F	143.3	25.84	0.639				
	4.0	Slender	F	215.3	42.58	0.820	Slender	F	214.1	42.20	0.813	Slender	F	198.8	37.56	0.724	Slender	F	195.1	36.52	0.704				
	5.0	Semi-compact		-	-	0.834	Semi-compact		-	-	0.834	Slender	F	249.0	48.54	0.778	Slender	F	244.6	47.21	0.756				
125 x 100	3.0	Slender	F	270.0	41.28	0.745	Slender	F	268.5	40.94	0.739	Slender	F	250.2	36.83	0.664	Slender	F	246.0	35.93	0.648				
	4.0	Slender	F	366.7	58.08	0.812	Slender	F	364.8	57.62	0.806	Slender	F	340.6	51.83	0.725	Slender	F	335.0	50.54	0.707				
	5.0	Semi-compact		-	-	0.825	Semi-compact		-	-	0.825	Slender	F	427.8	66.91	0.775	Slender	F	420.9	65.24	0.755				
	6.0	Compact		-	-	1.00	Compact		-	-	1.00	Semi-compact		-	-	0.815	Slender	F	502.2	79.66	0.796				
150 x 120	4.0	Slender	F	627.4	80.97	0.769	Slender	F	624.1	80.31	0.763	Slender	F	581.8	72.21	0.686	Slender	F	572.0	70.43	0.669				
	5.0	Slender	F	793.0	105.2	0.822	Slender	F	789.0	104.4	0.816	Slender	F	737.0	93.93	0.734	Slender	F	724.8	91.57	0.716				
	6.0	Semi-compact		-	-	0.825	Semi-compact		-	-	0.825	Slender	F	887.1	115.6	0.775	Slender	F	872.7	112.7	0.755				
	8.0	Compact		-	-	1.00	Compact		-	-	1.00	Semi-compact		-	-	0.808	Semi-compact		-	-	0.808				
175 x 120	5.0	Slender	F	1150	130.9	0.815	Slender	F	1145	129.9	0.809	Slender	F	1074	117.8	0.733	Slender	F	1057	115.1	0.716				
	6.0	Semi-compact		-	-	0.818	Semi-compact		-	-	0.818	Slender	F	1294	144.9	0.771	Slender	F	1274	141.5	0.753				
	8.0	Compact		-	-	1.00	Compact		-	-	1.00	Semi-compact		-	-	0.803	Semi-compact		-	-	0.803				

β_w is 1.0 for plastic and compact sections, Z_x/S_x for semi-compact sections and $Z_{x\text{ eff}}/S_x$ for slender sections.

W indicates that the web is slender.

F indicates that the flange is slender.

Only the sections which can be semi-compact or slender when subject to pure bending are given in the table.

Effective section properties are only applicable to slender cross-sections; gross properties should be used for plastic, compact and semi-compact cross-sections.

For explanation of table see Section 8.3.

Table 19 DOUBLE CHANNELS BACK TO BACK

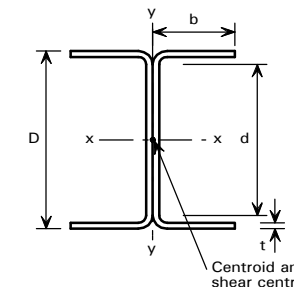

CLASSIFICATION & EFFECTIVE SECTION PROPERTIES FOR SECTIONS SUBJECT TO PURE BENDING AXIS X-X

D x 2b mm	t mm	1.4301 (304)						1.4401 (316) and 1.4404 (316L)						1.4362 (SAF 2304)						1.4462 (2205)					
		Classification		Properties				Classification		Properties				Classification		Properties				Classification		Properties			
				$I_{x\text{ eff}}$ cm ⁴	$Z_{x\text{ eff}}$ cm ³	β_w	$I_{x\text{ eff}}$ cm ⁴			$Z_{x\text{ eff}}$ cm ³	β_w	$I_{x\text{ eff}}$ cm ⁴	$Z_{x\text{ eff}}$ cm ³			β_w	$I_{x\text{ eff}}$ cm ⁴	$Z_{x\text{ eff}}$ cm ³	β_w						
200 x 150	5.0	Slender	F	1788	173.3	0.768	Slender	F	1779	172.0	0.762	Slender	F	1662	155.1	0.687	Slender	F	1635	151.4	0.671				
	6.0	Slender	F	2168	214.7	0.810	Slender	F	2157	213.1	0.803	Slender	F	2017	192.3	0.725	Slender	F	1985	187.6	0.707				
	8.0	Compact	-	-	1.00	Compact	-	-	1.00	Compact	-	-	1.00	Slender	F	2702	266.5	0.787	Slender	F	2660	260.1	0.768		
	10.0	Compact	-	-	1.00	Compact	-	-	1.00	Semi-compact	-	-	0.806	Semi-compact	-	-	0.806	Semi-compact	-	-	0.806				
225 x 150	6.0	Slender	F	2883	254.0	0.804	Slender	F	2870	252.2	0.798	Slender	F	2693	228.9	0.725	Slender	F	2651	223.6	0.708				
	8.0	Compact	-	-	1.00	Compact	-	-	1.00	Slender	F	3611	316.8	0.784	Slender	F	3557	309.6	0.766						
	10.0	Compact	-	-	1.00	Compact	-	-	1.00	Semi-compact	-	-	0.801	Semi-compact	-	-	0.801	Semi-compact	-	-	0.801				
250 x 200	6.0	Slender	F	4319	330.2	0.745	Slender	F	4296	327.6	0.739	Slender	F	4003	294.6	0.664	Slender	F	3936	287.4	0.648				
	8.0	Slender	F	5866	464.6	0.812	Slender	F	5837	460.9	0.806	Slender	F	5450	414.7	0.725	Slender	F	5359	404.3	0.707				
	10.0	Semi-compact	-	-	0.825	Semi-compact	-	-	0.825	Semi-compact	-	-	0.775	Slender	F	6845	535.3	0.775	Slender	F	6733	522.0	0.755		
	12.0	Compact	-	-	1.00	Compact	-	-	1.00	Semi-compact	-	-	0.815	Semi-compact	-	-	0.815	Slender	F	8034	637.3	0.796			
300 x 200	8.0	Slender	F	9113	602.1	0.804	Slender	F	9070	597.7	0.798	Slender	F	8511	542.5	0.725	Slender	F	8380	530.1	0.708				
	10.0	Semi-compact	-	-	0.816	Semi-compact	-	-	0.816	Slender	F	10700	699.1	0.770	Slender	F	10540	683.2	0.753						
	12.0	Compact	-	-	1.00	Compact	-	-	1.00	Semi-compact	-	-	0.807	Semi-compact	-	-	0.807	Slender	F	12610	834.0	0.790			
	15.0	Compact	-	-	1.00	Compact	-	-	1.00	Compact	-	-	1.00	Compact	-	-	1.00	Semi-compact	-	-	0.794				
350 x 250	8.0	Slender	F	14860	819.7	0.757	Slender	F	14780	813.4	0.752	Slender	F	13830	735.8	0.680	Slender	F	13610	718.7	0.664				
	10.0	Slender	F	18820	1065	0.807	Slender	F	18730	1057	0.801	Slender	F	17540	956.5	0.725	Slender	F	17260	933.9	0.708				
	12.0	Semi-compact	-	-	0.822	Semi-compact	-	-	0.822	Semi-compact	-	-	0.763	Slender	F	21170	1178	0.763	Slender	F	20840	1150	0.745		
	15.0	Compact	-	-	1.00	Compact	-	-	1.00	Semi-compact	-	-	0.810	Semi-compact	-	-	0.810	Slender	F	25940	1470	0.792			
400 x 300	8.0	Slender	F	22440	1059	0.718	Slender	F	22320	1051	0.712	Slender	F	20840	949.8	0.644	Slender	F	20510	927.8	0.629				
	10.0	Slender	F	28620	1386	0.768	Slender	F	28470	1375	0.762	Slender	F	26590	1241	0.687	Slender	F	26160	1211	0.671				
	12.0	Slender	F	34690	1717	0.810	Slender	F	34520	1704	0.803	Slender	F	32290	1538	0.725	Slender	F	31760	1500	0.707				
	15.0	Semi-compact	-	-	0.822	Semi-compact	-	-	0.822	Semi-compact	-	-	0.773	Slender	F	40570	1984	0.773	Slender	F	39930	1936	0.754		

β_w is 1.0 for plastic and compact sections, Z_x/S_x for semi-compact sections and $Z_{x\text{ eff}}/S_x$ for slender sections.

W indicates that the web is slender.

F indicates that the flange is slender.

Only the sections which can be semi-compact or slender when subject to pure bending are given in the table.

Effective section properties are only applicable to slender cross-sections; gross properties should be used for plastic, compact and semi-compact cross-sections.

For explanation of table see Section 8.3.

Table 20 EQUAL ANGLES

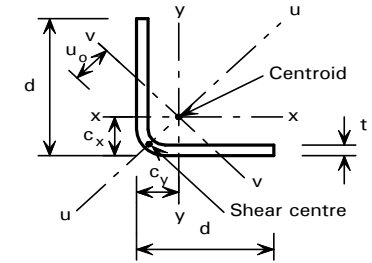

CLASSIFICATION & EFFECTIVE SECTION PROPERTIES FOR SECTIONS SUBJECT TO PURE BENDING AXIS X-X

d x d mm	t mm	1.4301 (304)				1.4401 (316) and 1.4404 (316L)				1.4326 (SAF 2304)				1.4462 (2205)							
		Classification	Properties				Classification	Properties				Classification	Properties				Classification	Properties			
			Leg parallel to x-x axis in compression		Leg parallel to x-x axis in tension			Leg parallel to x-x axis in compression		Leg parallel to x-x axis in tension			Leg parallel to x-x axis in compression		Leg parallel to x-x axis in tension			Leg parallel to x-x axis in compression		Leg parallel to x-x axis in tension	
			$I_{x\text{ eff}}$ cm ⁴	$Z_{x\text{ eff}}$ cm ³	$I_{x\text{ eff}}$ cm ⁴	$Z_{x\text{ eff}}$ cm ³		$I_{x\text{ eff}}$ cm ⁴	$Z_{x\text{ eff}}$ cm ³	$I_{x\text{ eff}}$ cm ⁴	$Z_{x\text{ eff}}$ cm ³		$I_{x\text{ eff}}$ cm ⁴	$Z_{x\text{ eff}}$ cm ³	$I_{x\text{ eff}}$ cm ⁴	$Z_{x\text{ eff}}$ cm ³		$I_{x\text{ eff}}$ cm ⁴	$Z_{x\text{ eff}}$ cm ³	$I_{x\text{ eff}}$ cm ⁴	$Z_{x\text{ eff}}$ cm ³
50 x 50	5.0	Non Slender	-	-	-	-	Non Slender	-	-	-	-	Slender	10.46	3.043	8.992	2.727	Slender	10.28	3.019	7.961	2.508
75 x 75	6.0	Slender	45.16	8.516	44.82	8.469	Slender	44.94	8.497	43.15	8.250	Slender	41.90	8.222	25.53	5.745	Slender	41.14	8.150	22.37	5.245
	8.0	Non Slender	-	-	-	-	Non Slender	-	-	-	-	Slender	56.53	10.94	53.40	10.50	Slender	55.60	10.85	47.42	9.671
100 x 100	8.0	Slender	142.7	20.19	141.7	20.08	Slender	142.0	20.14	136.4	19.56	Slender	132.4	19.49	80.70	13.62	Slender	130.0	19.32	70.71	12.43
	10.0	Non Slender	-	-	-	-	Non Slender	-	-	-	-	Slender	167.4	24.34	143.9	21.82	Slender	164.6	24.15	127.4	20.06
120 x 120	8.0	Slender	243.6	29.02	185.0	23.78	Slender	242.4	28.95	177.6	23.11	Slender	224.8	27.94	101.3	15.70	Slender	220.5	27.68	88.08	14.25
	10.0	Non Slender	-	-	-	-	Non Slender	-	-	-	-	Slender	286.9	35.10	186.6	25.70	Slender	281.8	34.79	163.8	23.49
	12.0	Non Slender	-	-	-	-	Non Slender	-	-	-	-	Slender	347.1	42.07	298.3	37.70	Slender	341.2	41.73	264.1	34.67
150 x 150	8.0	Slender	464.4	45.02	247.7	28.57	Slender	461.7	44.89	237.0	27.71	Slender	425.9	43.17	129.6	18.28	Slender	417.3	42.73	111.6	16.49
	10.0	Slender	594.8	56.69	451.6	46.44	Slender	591.7	56.55	433.5	45.15	Slender	548.9	54.57	247.4	30.66	Slender	538.4	54.05	215.0	27.84
	12.0	Slender	722.6	68.13	717.1	67.75	Slender	719.0	67.97	690.4	66.00	Slender	670.4	65.78	408.5	45.96	Slender	658.3	65.20	358.0	41.96
	15.0	Non Slender	-	-	-	-	Non Slender	-	-	-	-	Slender	847.3	82.16	728.4	73.64	Slender	833.1	81.50	644.9	67.71
200 x 200	8.0	Slender	1052	78.64	342.4	34.94	Slender	1046	78.39	326.2	33.79	Slender	959.4	75.06	169.5	21.54	Slender	939.1	74.24	144.3	19.29
	10.0	Slender	1363	99.72	653.6	58.57	Slender	1355	99.44	624.6	56.77	Slender	1248	95.52	337.6	37.16	Slender	1223	94.53	289.8	33.46
	12.0	Slender	1674	120.6	1079	87.79	Slender	1665	120.3	1034	85.25	Slender	1540	115.9	578.8	57.10	Slender	1510	114.8	500.7	51.68
	15.0	Slender	2133	151.4	1930	140.8	Slender	2122	151.0	1856	137.0	Slender	1975	146.0	1084	94.58	Slender	1939	144.7	947.3	86.18

Only the sections which can be semi-compact or slender when subject to pure bending are given in the table.

Effective section properties are only applicable to slender cross-sections; gross properties should be used for plastic, compact and semi-compact cross-sections.

For explanation of table see Section 8.3.

Table 21 RECTANGULAR HOLLOW SECTIONS

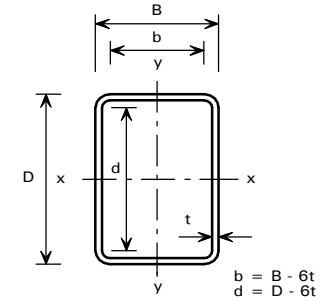

CLASSIFICATION & EFFECTIVE SECTION PROPERTIES FOR SECTIONS SUBJECT TO PURE BENDING AXIS Y-Y

D x B mm	t mm	1.4301 (304)				1.4401 (316) and 1.4404 (316L)				1.4362 (SAF 2304)				1.4462 (2205)			
		Classification		Properties		Classification		Properties		Classification		Properties		Classification		Properties	
				$I_{y\text{ eff}}$ cm ⁴	$Z_{y\text{ eff}}$ cm ³			$I_{y\text{ eff}}$ cm ⁴	$Z_{y\text{ eff}}$ cm ³			$I_{y\text{ eff}}$ cm ⁴	$Z_{y\text{ eff}}$ cm ³			$I_{y\text{ eff}}$ cm ⁴	$Z_{y\text{ eff}}$ cm ³
50 x 25	1.5	Compact		-	-	Compact		-	-	Slender	F	2.096	1.626	Slender	F	2.058	1.577
60 x 30	2.0	Plastic		-	-	Plastic		-	-	Slender	F	4.865	3.218	Slender	F	4.780	3.124
80 x 40	2.0	Slender	F	12.22	6.028	Slender	F	12.14	5.966	Slender	F	11.20	5.217	Slender	F	10.98	5.054
	3.0	Plastic		-	-	Plastic		-	-	Semi-compact		-	-	Semi-compact		-	-
100 x 50	2.0	Slender	F	23.09	8.685	Slender	F	22.93	8.592	Slender	F	21.01	7.475	Slender	F	20.57	7.238
	3.0	Compact		-	-	Compact		-	-	Slender	F	33.54	13.00	Slender	F	32.93	12.61
150 x 75	3.0	Slender	F	116.9	29.31	Slender	F	116.1	29.00	Slender	F	106.4	25.23	Slender	F	104.2	24.43
	4.0	Semi-compact		-	-	Slender	F	161.2	42.84	Slender	F	149.0	37.53	Slender	F	146.1	36.37
	5.0	Plastic		-	-	Plastic		-	-	Slender	F	190.0	50.27	Slender	F	186.7	48.81
150 x 100	3.0	Slender	F	224.1	42.41	Slender	F	222.7	41.99	Slender	F	205.4	36.98	Slender	F	201.5	35.92
	4.0	Semi-compact		-	-	Slender	F	310.2	61.85	Slender	F	288.0	54.73	Slender	F	282.9	53.18
	5.0	Plastic		-	-	Plastic		-	-	Slender	F	369.1	73.29	Slender	F	363.1	71.31
200 x 100	4.0	Slender	F	369.4	69.48	Slender	F	366.9	68.73	Slender	F	336.2	59.80	Slender	F	329.2	57.90
	5.0	Slender	F	477.2	94.19	Slender	F	474.3	93.23	Slender	F	437.4	81.51	Slender	F	428.8	78.97
	6.0	Compact		-	-	Compact		-	-	Slender	F	536.6	104.0	Slender	F	526.8	100.9
200 x 125	4.0	Slender	F	611.6	92.48	Slender	F	607.8	91.54	Slender	F	559.7	80.40	Slender	F	548.9	78.03
	5.0	Slender	F	791.7	125.1	Slender	F	787.1	123.9	Slender	F	728.7	109.2	Slender	F	715.2	106.0
	6.0	Compact		-	-	Compact		-	-	Slender	F	896.0	139.3	Slender	F	880.4	135.3
250 x 125	6.0	Slender	F	1112	174.2	Slender	F	1106	172.4	Slender	F	1018	150.5	Slender	F	998.4	145.8

W indicates that the web is slender.

F indicates that the flange is slender.

Only the sections which can be semi-compact or slender when subject to pure bending are given in the table.

Effective section properties are only applicable to slender cross-sections; gross properties should be used for plastic, compact and semi-compact cross-sections.

For explanation of table see Section 8.3.

Table 21 RECTANGULAR HOLLOW SECTIONS

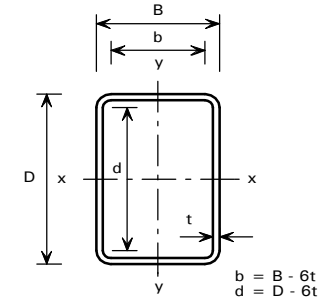

CLASSIFICATION & EFFECTIVE SECTION PROPERTIES FOR SECTIONS SUBJECT TO PURE BENDING AXIS Y-Y

D x B mm	t mm	1.4301 (304)				1.4401 (316) and 1.4404 (316L)				1.4362 (SAF 2304)				1.4462 (2205)			
		Classification		Properties		Classification		Properties		Classification		Properties		Classification		Properties	
				$I_{y\text{ eff}}$ cm ⁴	$Z_{y\text{ eff}}$ cm ³			$I_{y\text{ eff}}$ cm ⁴	$Z_{y\text{ eff}}$ cm ³			$I_{y\text{ eff}}$ cm ⁴	$Z_{y\text{ eff}}$ cm ³			$I_{y\text{ eff}}$ cm ⁴	$Z_{y\text{ eff}}$ cm ³
250 x 125	8.0	Plastic		-	-	Plastic		-	-	Slender	F	1404	220.9	Slender	F	1379	214.4
250 x 150	6.0	Slender	F	1682	219.7	Slender	F	1672	217.5	Slender	F	1544	191.2	Slender	F	1515	185.5
	8.0	Plastic		-	-	Plastic		-	-	Slender	F	2137	280.4	Slender	F	2100	272.5
300 x 150	6.0	Slender	F	1869	234.5	Slender	F	1857	232.0	Slender	F	1701	201.8	Slender	F	1666	195.4
	8.0	Semi-compact		-	-	Slender	F	2578	342.7	Slender	F	2383	300.3	Slender	F	2337	291.0
	10.0	Plastic		-	-	Plastic		-	-	Slender	F	3040	402.2	Slender	F	2987	390.5
300 x 200	6.0	Slender	F	3585	339.3	Slender	F	3563	335.9	Slender	F	3286	295.9	Slender	F	3224	287.3
	8.0	Semi-compact		-	-	Slender	F	4963	494.8	Slender	F	4608	437.9	Slender	F	4526	425.4
	10.0	Plastic		-	-	Plastic		-	-	Slender	F	5905	586.4	Slender	F	5809	570.5
350 x 175	6.0	Slender	F	2880	299.8	Slender	F	2860	296.5	Slender	F	2612	257.7	Slender	F	2556	249.5
	8.0	Slender	F	4045	447.5	Slender	F	4019	442.8	Slender	F	3696	386.2	Slender	F	3621	374.0
	10.0	Semi-compact		-	-	Semi-compact		-	-	Slender	F	4769	522.9	Slender	F	4681	506.9
	12.0	Plastic		-	-	Plastic		-	-	Slender	F	5800	661.7	Slender	F	5701	642.6
350 x 200	6.0	Slender	F	3893	356.1	Slender	F	3867	352.3	Slender	F	3543	308.0	Slender	F	3471	298.7
	8.0	Slender	F	5471	530.3	Slender	F	5437	525.0	Slender	F	5013	460.2	Slender	F	4915	446.3
	10.0	Semi-compact		-	-	Semi-compact		-	-	Slender	F	6478	622.5	Slender	F	6361	604.2
	12.0	Plastic		-	-	Plastic		-	-	Slender	F	7896	788.3	Slender	F	7764	766.2

W indicates that the web is slender.

F indicates that the flange is slender.

Only the sections which can be semi-compact or slender when subject to pure bending are given in the table.

Effective section properties are only applicable to slender cross-sections; gross properties should be used for plastic, compact and semi-compact cross-sections.

For explanation of table see Section 8.3.

Table 21 RECTANGULAR HOLLOW SECTIONS

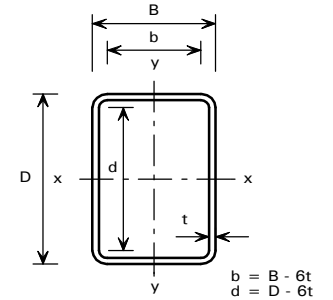

CLASSIFICATION & EFFECTIVE SECTION PROPERTIES FOR SECTIONS SUBJECT TO PURE BENDING AXIS Y-Y

D x B mm	t mm	1.4301 (304)				1.4401 (316) and 1.4404 (316L)				1.4362 (SAF 2304)				1.4462 (2205)			
		Classification		Properties		Classification		Properties		Classification		Properties		Classification		Properties	
				$I_{y\text{ eff}}$ cm ⁴	$Z_{y\text{ eff}}$ cm ³			$I_{y\text{ eff}}$ cm ⁴	$Z_{y\text{ eff}}$ cm ³			$I_{y\text{ eff}}$ cm ⁴	$Z_{y\text{ eff}}$ cm ³			$I_{y\text{ eff}}$ cm ⁴	$Z_{y\text{ eff}}$ cm ³
400 x 200	6.0	Slender	F	4171	369.8	Slender	F	4141	365.7	Slender	F	3774	317.9	Slender	F	3693	307.9
	8.0	Slender	F	5909	555.8	Slender	F	5870	549.9	Slender	F	5378	478.4	Slender	F	5266	463.2
	10.0	Slender	F	7634	753.5	Slender	F	7588	745.8	Slender	F	6998	652.1	Slender	F	6861	631.7
	12.0	Compact		-	-	Compact		-	-	Slender	F	8585	832.3	Slender	F	8428	807.3
	15.0	Plastic		-	-	Plastic		-	-	Semi-compact		-	-	Semi-compact		-	-
400 x 250	6.0	Slender	F	6911	494.9	Slender	F	6865	489.8	Slender	F	6299	430.5	Slender	F	6175	418.1
	8.0	Slender	F	9786	739.8	Slender	F	9725	732.4	Slender	F	8955	643.2	Slender	F	8781	624.2
	10.0	Slender	F	12670	1001	Slender	F	12590	991.4	Slender	F	11660	873.8	Slender	F	11440	848.2
	12.0	Compact		-	-	Compact		-	-	Slender	F	14340	1114	Slender	F	14090	1082
	15.0	Plastic		-	-	Plastic		-	-	Semi-compact		-	-	Semi-compact		-	-

W indicates that the web is slender.

F indicates that the flange is slender.

Only the sections which can be semi-compact or slender when subject to pure bending are given in the table.

Effective section properties are only applicable to slender cross-sections; gross properties should be used for plastic, compact and semi-compact cross-sections.

For explanation of table see Section 8.3.

Table 22 CHANNELS

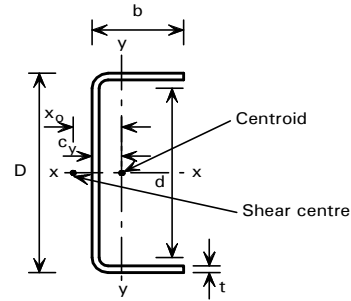

CLASSIFICATION & EFFECTIVE SECTION PROPERTIES FOR SECTIONS SUBJECT TO PURE BENDING AXIS Y-Y GRADES 1.4301 (304), 1.4401 (316) & 1.4404 (316L)

D x b mm mm	t mm	1.4301 (304)						1.4401 (316) and 1.4404 (316L)					
		Web in compression, toes in tension			Web in tension, toes in compression			Web in compression, toes in tension			Web in tension, toes in compression		
		Classification	$I_{y\text{ eff}}$ cm ⁴	$Z_{y\text{ eff}}$ cm ³	Classification	$I_{y\text{ eff}}$ cm ⁴	$Z_{y\text{ eff}}$ cm ³	Classification	$I_{y\text{ eff}}$ cm ⁴	$Z_{y\text{ eff}}$ cm ³	Classification	$I_{y\text{ eff}}$ cm ⁴	$Z_{y\text{ eff}}$ cm ³
50 x 25	2.0	Plastic	-	-	Slender	1.107	0.6254	Plastic	-	-	Slender	1.066	0.6010
75 x 35	3.0	Plastic	-	-	Semi-compact	-	-	Plastic	-	-	Semi-compact	-	-
100 x 50	3.0	Compact	-	-	Slender	8.880	2.415	Compact	-	-	Slender	8.593	2.333
	4.0	Plastic	-	-	Slender	17.71	5.003	Plastic	-	-	Slender	17.05	4.808
125 x 50	3.0	Slender	14.69	3.973	Slender	9.450	2.469	Slender	14.63	3.965	Slender	9.131	2.382
	4.0	Plastic	-	-	Slender	19.11	5.178	Plastic	-	-	Slender	18.40	4.974
150 x 60	4.0	Semi-compact	-	-	Slender	25.25	5.566	Slender	34.03	7.629	Slender	24.35	5.358
	5.0	Plastic	-	-	Semi-compact	-	-	Plastic	-	-	Semi-compact	-	-
175 x 60	5.0	Semi-compact	-	-	Semi-compact	-	-	Semi-compact	-	-	Semi-compact	-	-
	5.0	Slender	84.00	14.97	Slender	62.80	10.95	Slender	83.66	14.95	Slender	60.55	10.54
200 x 75	6.0	Compact	-	-	Slender	98.75	17.63	Compact	-	-	Slender	95.05	16.94
	6.0	Semi-compact	-	-	Slender	102.3	17.91	Slender	102.9	18.05	Slender	98.49	17.20
225 x 75	6.0	Semi-compact	-	-	Slender	102.3	17.91	Slender	102.9	18.05	Slender	98.49	17.20
	6.0	Slender	235.0	31.78	Slender	151.2	19.75	Slender	234.0	31.72	Slender	146.1	19.06
250 x 100	8.0	Plastic	-	-	Slender	305.7	41.42	Plastic	-	-	Slender	294.4	39.79
	8.0	Semi-compact	-	-	Slender	323.4	42.45	Slender	325.3	42.79	Slender	311.3	40.77
300 x 100	8.0	Semi-compact	-	-	Slender	323.4	42.45	Slender	325.3	42.79	Slender	311.3	40.77
	8.0	Slender	623.1	66.65	Slender	444.3	45.89	Slender	620.5	66.53	Slender	428.5	44.19
350 x 125	10.0	Semi-compact	-	-	Slender	773.5	82.17	Semi-compact	-	-	Slender	744.5	78.93
	8.0	Slender	1049	95.25	Slender	590.8	50.31	Slender	1044	95.05	Slender	572.2	48.67
400 x 150	10.0	Slender	1344	119.8	Slender	1004	87.61	Slender	1338	119.6	Slender	968.7	84.31
	12.0	Compact	-	-	Slender	1579	141.1	Compact	-	-	Slender	1520	135.5

Only the sections which can be semi-compact or slender when subject to pure bending are given in the table.

Effective section properties are only applicable to slender cross-sections; gross properties should be used for plastic, compact and semi-compact cross-sections.

For explanation of table see Section 8.3.

Table 22 continued CHANNELS

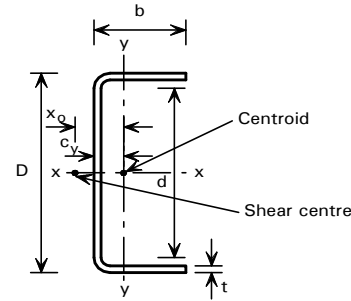

CLASSIFICATION & EFFECTIVE SECTION PROPERTIES FOR SECTIONS SUBJECT TO PURE BENDING AXIS Y-Y GRADES 1.4362 (SAF 2304) & 1.4462 (2205)

D x b mm mm	t mm	1.4362 (SAF 2304)						1.4462 (2205)					
		Web in compression, toes in tension			Web in tension, toes in compression			Web in compression, toes in tension			Web in tension, toes in compression		
		Classification	$I_{y\text{ eff}}$ cm ⁴	$Z_{y\text{ eff}}$ cm ³	Classification	$I_{y\text{ eff}}$ cm ⁴	$Z_{y\text{ eff}}$ cm ³	Classification	$I_{y\text{ eff}}$ cm ⁴	$Z_{y\text{ eff}}$ cm ³	Classification	$I_{y\text{ eff}}$ cm ⁴	$Z_{y\text{ eff}}$ cm ³
50 x 25	2.0	Compact	-	-	Slender	0.675	0.3724	Compact	-	-	Slender	0.615	0.3378
	3.0	Plastic	-	-	Semi-compact	-	-	Plastic	-	-	Semi-compact	-	-
75 x 35	3.0	Compact	-	-	Slender	3.098	1.215	Compact	-	-	Slender	2.800	1.093
	4.0	Plastic	-	-	Semi-compact	-	-	Plastic	-	-	Slender	5.480	2.235
100 x 50	3.0	Slender	13.50	3.824	Slender	6.041	1.616	Slender	13.31	3.800	Slender	5.688	1.519
	4.0	Compact	-	-	Slender	10.81	2.979	Compact	-	-	Slender	9.842	2.703
	5.0	Plastic	-	-	Slender	18.09	5.150	Plastic	-	-	Slender	16.21	4.589
125 x 50	3.0	Slender	13.80	3.863	Slender	6.235	1.602	Slender	13.60	3.838	Slender	5.820	1.491
	4.0	Slender	18.96	5.188	Slender	11.51	3.044	Slender	18.73	5.159	Slender	10.42	2.745
	5.0	Compact	-	-	Slender	19.56	5.333	Compact	-	-	Slender	17.48	4.740
	6.0	Plastic	-	-	Semi-compact	-	-	Plastic	-	-	Semi-compact	-	-
150 x 60	4.0	Slender	32.22	7.446	Slender	15.98	3.453	Slender	31.78	7.400	Slender	14.73	3.174
	5.0	Slender	41.07	9.339	Slender	26.23	5.810	Slender	40.58	9.289	Slender	23.68	5.222
	6.0	Compact	-	-	Slender	40.57	9.215	Compact	-	-	Slender	36.25	8.190
	8.0	Plastic	-	-	Compact	-	-	Plastic	-	-	Semi-compact	-	-
175 x 60	5.0	Slender	41.75	9.407	Slender	27.33	5.895	Slender	41.22	9.354	Slender	24.59	5.280
	6.0	Slender	50.54	11.27	Slender	42.59	9.410	Slender	49.97	11.22	Slender	37.99	8.350
	8.0	Plastic	-	-	Compact	-	-	Plastic	-	-	Semi-compact	-	-
200 x 75	5.0	Slender	79.14	14.58	Slender	39.46	6.748	Slender	78.04	14.49	Slender	36.30	6.188
	6.0	Slender	96.67	17.56	Slender	59.25	10.33	Slender	95.46	17.46	Slender	53.57	9.300

Only the sections which can be semi-compact or slender when subject to pure bending are given in the table.

Effective section properties are only applicable to slender cross-sections; gross properties should be used for plastic, compact and semi-compact cross-sections.

For explanation of table see Section 8.3.

Table 22 continued CHANNELS

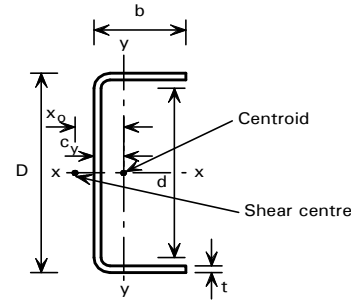

CLASSIFICATION & EFFECTIVE SECTION PROPERTIES FOR SECTIONS SUBJECT TO PURE BENDING AXIS Y-Y GRADES 1.4362 (SAF 2304) & 1.4462 (2205)

D x b mm mm	t mm	1.4362 (SAF 2304)						1.4462 (2205)					
		Web in compression, toes in tension			Web in tension, toes in compression			Web in compression, toes in tension			Web in tension, toes in compression		
		Classification	$I_{y\text{ eff}}$ cm ⁴	$Z_{y\text{ eff}}$ cm ³	Classification	$I_{y\text{ eff}}$ cm ⁴	$Z_{y\text{ eff}}$ cm ³	Classification	$I_{y\text{ eff}}$ cm ⁴	$Z_{y\text{ eff}}$ cm ³	Classification	$I_{y\text{ eff}}$ cm ⁴	$Z_{y\text{ eff}}$ cm ³
200 x 75	8.0	Compact	-	-	Slender	118.5	21.49	Compact	-	-	Slender	105.6	19.05
	10.0	Plastic	-	-	Compact	-	-	Plastic	-	-	Semi-compact	-	-
225 x 75	6.0	Slender	97.79	17.65	Slender	60.97	10.42	Slender	96.52	17.55	Slender	54.96	9.358
	8.0	Semi-compact	-	-	Slender	123.0	21.85	Slender	130.7	23.37	Slender	109.5	19.35
	10.0	Plastic	-	-	Compact	-	-	Plastic	-	-	Semi-compact	-	-
250 x 100	6.0	Slender	220.8	30.91	Slender	99.76	12.81	Slender	217.6	30.70	Slender	93.12	11.93
	8.0	Slender	303.4	41.50	Slender	184.1	24.35	Slender	299.7	41.27	Slender	166.8	21.96
	10.0	Compact	-	-	Slender	313.0	42.66	Compact	-	-	Slender	279.7	37.92
	12.0	Plastic	-	-	Semi-compact	-	-	Plastic	-	-	Semi-compact	-	-
300 x 100	8.0	Slender	309.1	41.84	Slender	192.7	24.70	Slender	305.0	41.60	Slender	173.7	22.18
	10.0	Slender	391.2	52.25	Slender	331.4	43.72	Slender	386.7	51.99	Slender	295.5	38.79
	12.0	Compact	-	-	Semi-compact	-	-	Compact	-	-	Semi-compact	-	-
350 x 125	8.0	Slender	585.7	64.84	Slender	281.6	28.55	Slender	577.3	64.42	Slender	259.7	26.26
	10.0	Slender	749.6	81.49	Slender	462.7	48.00	Slender	740.1	81.02	Slender	417.9	43.17
	12.0	Slender	908.7	97.72	Slender	716.9	76.13	Slender	898.4	97.23	Slender	640.7	67.69
	15.0	Plastic	-	-	Semi-compact	-	-	Plastic	-	-	Semi-compact	-	-
400 x 150	8.0	Slender	981.2	92.38	Slender	407.9	34.24	Slender	966.0	91.71	Slender	385.1	32.27
	10.0	Slender	1266	116.7	Slender	631.4	53.98	Slender	1248	115.9	Slender	580.8	49.51
	12.0	Slender	1546	140.5	Slender	947.9	82.62	Slender	1527	139.7	Slender	857.1	74.40
	15.0	Semi-compact	-	-	Slender	1618	145.3	Semi-compact	-	-	Slender	1444	129.1

Only the sections which can be semi-compact or slender when subject to pure bending are given in the table.

Effective section properties are only applicable to slender cross-sections; gross properties should be used for plastic, compact and semi-compact cross-sections.

For explanation of table see Section 8.3.

Table 23 DOUBLE CHANNELS BACK TO BACK

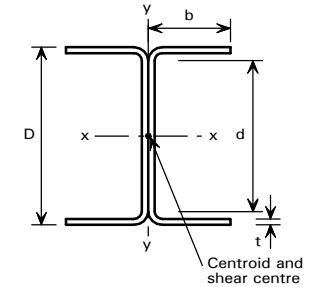

CLASSIFICATION & EFFECTIVE SECTION PROPERTIES FOR SECTIONS SUBJECT TO PURE BENDING AXIS Y-Y

D x 2b mm mm	t mm	1.4301 (304)		1.4401 (316) and 1.4404 (316L)		1.4362 (SAF 2304)		1.4462 (2205)					
		Classification	Properties		Classification	Properties		Classification	Properties		Classification	Properties	
			$I_{y\text{ eff}}$ cm ⁴	$Z_{y\text{ eff}}$ cm ³		$I_{y\text{ eff}}$ cm ⁴	$Z_{y\text{ eff}}$ cm ³		$I_{y\text{ eff}}$ cm ⁴	$Z_{y\text{ eff}}$ cm ³		$I_{y\text{ eff}}$ cm ⁴	$Z_{y\text{ eff}}$ cm ³
50 x 50	2.0	Slender	3.932	1.591	Slender	3.860	1.568	Slender	3.072	1.300	Slender	2.923	1.247
	3.0	Compact	-	-	Compact	-	-	Semi-compact	-	-	Slender	6.014	2.430
75 x 70	3.0	Slender	17.13	4.901	Slender	16.81	4.827	Slender	13.34	3.987	Slender	12.67	3.822
	4.0	Compact	-	-	Compact	-	-	Slender	22.36	6.432	Slender	21.16	6.149
	5.0	Compact	-	-	Compact	-	-	Semi-compact	-	-	Semi-compact	-	-
100 x 100	3.0	Slender	37.68	7.924	Slender	37.04	7.813	Slender	30.28	6.616	Slender	29.05	6.393
	4.0	Slender	62.91	12.73	Slender	61.76	12.54	Slender	49.16	10.40	Slender	46.76	9.979
	5.0	Semi-compact	-	-	Semi-compact	-	-	Slender	73.04	15.00	Slender	69.21	14.35
125 x 100	3.0	Slender	37.80	7.900	Slender	37.17	7.789	Slender	30.56	6.599	Slender	29.37	6.380
	4.0	Slender	63.03	12.74	Slender	61.88	12.54	Slender	49.39	10.37	Slender	47.04	9.954
	5.0	Semi-compact	-	-	Semi-compact	-	-	Slender	73.29	15.00	Slender	69.48	14.34
	6.0	Compact	-	-	Compact	-	-	Semi-compact	-	-	Slender	96.58	19.49
150 x 120	4.0	Slender	94.29	16.23	Slender	92.65	15.99	Slender	75.22	13.41	Slender	72.02	12.92
	5.0	Slender	140.7	23.57	Slender	138.1	23.21	Slender	110.0	19.16	Slender	104.6	18.37
	6.0	Semi-compact	-	-	Semi-compact	-	-	Slender	152.0	25.92	Slender	144.1	24.79
	8.0	Compact	-	-	Compact	-	-	Semi-compact	-	-	Semi-compact	-	-
175 x 120	5.0	Slender	140.9	23.60	Slender	138.4	23.23	Slender	110.3	19.14	Slender	105.0	18.35
	6.0	Semi-compact	-	-	Semi-compact	-	-	Slender	152.4	25.93	Slender	144.5	24.79
	8.0	Compact	-	-	Compact	-	-	Semi-compact	-	-	Semi-compact	-	-
200 x 150	5.0	Slender	230.4	31.68	Slender	226.4	31.21	Slender	184.0	26.16	Slender	176.3	25.22
	6.0	Slender	319.3	42.99	Slender	313.5	42.33	Slender	250.4	34.98	Slender	238.6	33.57
	8.0	Compact	-	-	Compact	-	-	Slender	417.4	56.46	Slender	395.4	53.95

Only the sections which can be semi-compact or slender when subject to pure bending are given in the table.

Effective section properties are only applicable to slender cross-sections; gross properties should be used for plastic, compact and semi-compact cross-sections.

For explanation of table see Section 8.3.

Table 23 DOUBLE CHANNELS BACK TO BACK

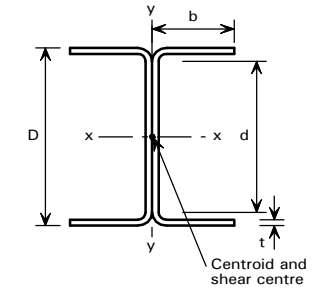

CLASSIFICATION & EFFECTIVE SECTION PROPERTIES FOR SECTIONS SUBJECT TO PURE BENDING AXIS Y-Y

D x 2b mm mm	t mm	1.4301 (304)		1.4401 (316) and 1.4404 (316L)		1.4362 (SAF 2304)		1.4462 (2205)					
		Classification	Properties		Classification	Properties		Classification	Properties		Classification	Properties	
			$I_{y\text{ eff}}$ cm ⁴	$Z_{y\text{ eff}}$ cm ³		$I_{y\text{ eff}}$ cm ⁴	$Z_{y\text{ eff}}$ cm ³		$I_{y\text{ eff}}$ cm ⁴	$Z_{y\text{ eff}}$ cm ³		$I_{y\text{ eff}}$ cm ⁴	$Z_{y\text{ eff}}$ cm ³
200 x 150	10.0	Compact	-	-	Compact	-	-	Semi-compact	-	-	Semi-compact	-	-
225 x 150	6.0	Slender	319.6	43.01	Slender	313.8	42.34	Slender	251.1	34.96	Slender	239.4	33.55
	8.0	Compact	-	-	Compact	-	-	Slender	418.2	56.52	Slender	396.4	53.98
	10.0	Compact	-	-	Compact	-	-	Semi-compact	-	-	Semi-compact	-	-
250 x 200	6.0	Slender	604.8	63.20	Slender	594.8	62.31	Slender	489.0	52.79	Slender	469.9	51.04
	8.0	Slender	1008	101.9	Slender	990.1	100.3	Slender	790.3	82.97	Slender	752.7	79.63
	10.0	Semi-compact	-	-	Semi-compact	-	-	Slender	1172	120.0	Slender	1111	114.8
	12.0	Compact	-	-	Compact	-	-	Semi-compact	-	-	Slender	1545	155.9
300 x 200	8.0	Slender	1010	102.0	Slender	991.9	100.4	Slender	793.6	82.86	Slender	756.5	79.52
	10.0	Semi-compact	-	-	Semi-compact	-	-	Slender	1176	120.1	Slender	1115	114.8
	12.0	Compact	-	-	Compact	-	-	Semi-compact	-	-	Slender	1551	156.4
	15.0	Compact	-	-	Compact	-	-	Compact	-	-	Semi-compact	-	-
350 x 250	8.0	Slender	1655	137.0	Slender	1627	135.0	Slender	1330	113.6	Slender	1276	109.7
	10.0	Slender	2464	199.1	Slender	2419	196.0	Slender	1934	161.9	Slender	1843	155.4
	12.0	Semi-compact	-	-	Semi-compact	-	-	Slender	2665	218.9	Slender	2530	209.4
	15.0	Compact	-	-	Compact	-	-	Semi-compact	-	-	Slender	3781	305.0
400 x 300	8.0	Slender	2505	176.3	Slender	2467	174.0	Slender	2064	149.5	Slender	1993	145.1
	10.0	Slender	3685	253.4	Slender	3622	249.7	Slender	2944	209.3	Slender	2820	201.8
	12.0	Slender	5108	343.9	Slender	5015	338.6	Slender	4006	279.9	Slender	3817	268.6
	15.0	Semi-compact	-	-	Semi-compact	-	-	Slender	5942	405.1	Slender	5635	387.3

Only the sections which can be semi-compact or slender when subject to pure bending are given in the table.

Effective section properties are only applicable to slender cross-sections; gross properties should be used for plastic, compact and semi-compact cross-sections.

For explanation of table see Section 8.3.

Table 24 DOUBLE ANGLES BACK TO BACK

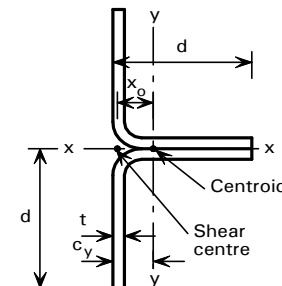

CLASSIFICATION & EFFECTIVE SECTION PROPERTIES FOR SECTIONS SUBJECT TO PURE BENDING AXIS Y-Y

2d x d mm mm	t mm	1.4301 (304)				1.4401 (316) and 1.4404 (316L)				1.4362 (SAF 2304)				1.4462 (2205)							
		Classification	Properties				Classification	Properties				Classification	Properties				Classification	Properties			
			Leg parallel to y-y axis in compression		Leg parallel to y-y axis in tension			Leg parallel to y-y axis in compression		Leg parallel to y-y axis in tension			Leg parallel to y-y axis in compression		Leg parallel to y-y axis in tension			Leg parallel to y-y axis in compression		Leg parallel to y-y axis in tension	
			$I_{y\text{ eff}}$ cm ⁴	$Z_{y\text{ eff}}$ cm ³	$I_{y\text{ eff}}$ cm ⁴	$Z_{y\text{ eff}}$ cm ³		$I_{y\text{ eff}}$ cm ⁴	$Z_{y\text{ eff}}$ cm ³	$I_{y\text{ eff}}$ cm ⁴	$Z_{y\text{ eff}}$ cm ³		$I_{y\text{ eff}}$ cm ⁴	$Z_{y\text{ eff}}$ cm ³	$I_{y\text{ eff}}$ cm ⁴	$Z_{y\text{ eff}}$ cm ³		$I_{y\text{ eff}}$ cm ⁴	$Z_{y\text{ eff}}$ cm ³	$I_{y\text{ eff}}$ cm ⁴	$Z_{y\text{ eff}}$ cm ³
100 x 50	5.0	Non Slender	-	-	-	-	Non Slender	-	-	-	-	Slender	20.92	6.086	17.98	5.455	Slender	20.57	6.037	15.92	5.016
150 x 75	6.0	Slender	90.32	17.03	89.64	16.94	Slender	89.88	16.99	86.30	16.50	Slender	83.80	16.44	51.07	11.49	Slender	82.28	16.30	44.75	10.49
	8.0	Non Slender	-	-	-	-	Non Slender	-	-	-	-	Slender	113.1	21.87	106.8	20.99	Slender	111.2	21.70	94.84	19.34
200 x 100	8.0	Slender	285.5	40.37	283.3	40.15	Slender	284.1	40.28	272.7	39.11	Slender	264.9	38.98	161.4	27.23	Slender	260.1	38.64	141.4	24.86
	10.0	Non Slender	-	-	-	-	Non Slender	-	-	-	-	Slender	334.7	48.69	287.8	43.64	Slender	329.1	48.30	254.8	40.12
240 x 120	8.0	Slender	487.3	58.05	370.0	47.55	Slender	484.7	57.91	355.1	46.23	Slender	449.7	55.88	202.7	31.40	Slender	441.1	55.35	176.2	28.51
	10.0	Non Slender	-	-	-	-	Non Slender	-	-	-	-	Slender	573.8	70.19	373.1	51.40	Slender	563.5	69.59	327.6	46.99
	12.0	Non Slender	-	-	-	-	Non Slender	-	-	-	-	Slender	694.1	84.13	596.7	75.41	Slender	682.4	83.46	528.3	69.34
300 x 150	8.0	Slender	928.8	90.04	495.4	57.14	Slender	923.5	89.79	473.9	55.42	Slender	851.9	86.34	259.2	36.56	Slender	834.6	85.46	223.1	32.98
	10.0	Slender	1189	113.4	903.3	92.88	Slender	1183	113.1	867.0	90.29	Slender	1097	109.1	494.9	61.33	Slender	1076	108.1	430.1	55.68
	12.0	Slender	1445	136.3	1434	135.5	Slender	1438	135.9	1380	132.0	Slender	1340	131.6	817.1	91.92	Slender	1316	130.4	715.9	83.91
	15.0	Non Slender	-	-	-	-	Non Slender	-	-	-	-	Slender	1694	164.3	1456	147.3	Slender	1666	163.0	1289	135.4
400 x 200	8.0	Slender	2105	157.3	684.8	69.88	Slender	2092	156.8	652.3	67.58	Slender	1918	150.1	339.0	43.08	Slender	1878	148.5	288.5	38.58
	10.0	Slender	2727	199.4	1307	117.1	Slender	2711	198.9	1249	113.5	Slender	2497	191.0	675.2	74.31	Slender	2446	189.1	579.7	66.92
	12.0	Slender	3349	241.2	2159	175.6	Slender	3330	240.6	2069	170.5	Slender	3081	231.8	1157	114.2	Slender	3020	229.5	1001	103.4
	15.0	Slender	4267	302.8	3860	281.6	Slender	4245	302.1	3712	274.1	Slender	3951	292.0	2168	189.2	Slender	3878	289.4	1894	172.4

Only the sections which can be semi-compact or slender when subject to pure bending are given in the table.

Effective section properties are only applicable to slender cross-sections; gross properties should be used for plastic, compact and semi-compact cross-sections.

For explanation of table see Section 8.3.

[Blank Page]

C. MEMBER CAPACITIES

GRADE 1.4301 (304)

Table 25

COMPRESSION

**CIRCULAR HOLLOW SECTIONS
SUBJECT TO AXIAL COMPRESSION**

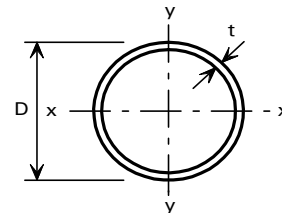

COMPRESSION RESISTANCE FOR GRADE 1.4301 (304)

D mm	t mm	Mass per Metre kg	Compression Resistance P_c (kN)												
			for Effective Length L_e (m)												
			1.0	1.5	2.0	2.5	3.0	3.5	4.0	5.0	6.0	7.0	8.0	9.0	10.0
21.3	1.0	0.50	4.71	2.36	1.40	0.920	0.652	0.485	0.376	0.244	0.171	0.127	0.098	0.077	0.063
	1.2	0.60	5.51	2.76	1.63	1.07	0.761	0.567	0.438	0.285	0.200	0.148	0.114	0.090	0.073
	1.6	0.78	6.99	3.48	2.06	1.36	0.959	0.714	0.553	0.359	0.252	0.186	0.143	0.114	0.092
	2.0	0.96	8.31	4.13	2.44	1.60	1.13	0.844	0.653	0.424	0.297	0.220	0.169	0.134	0.109
	2.3	1.08	9.20	4.56	2.69	1.77	1.25	0.931	0.720	0.467	0.328	0.242	0.187	0.148	0.120
33.7	1.0	0.81	14.3	8.47	5.29	3.57	2.56	1.93	1.50	0.982	0.693	0.515	0.398	0.316	0.258
	1.6	1.27	22.1	13.0	8.06	5.43	3.89	2.93	2.28	1.49	1.05	0.781	0.603	0.480	0.391
	2.0	1.57	26.9	15.7	9.74	6.56	4.70	3.53	2.75	1.80	1.27	0.943	0.728	0.579	0.471
	2.5	1.94	32.6	18.9	11.7	7.86	5.63	4.23	3.29	2.15	1.52	1.13	0.870	0.692	0.564
	3.2	2.42	39.9	22.9	14.1	9.48	6.79	5.09	3.96	2.59	1.83	1.36	1.05	0.832	0.678
42.4	1.0	1.03	21.9	14.9	9.89	6.84	4.97	3.77	2.95	1.94	1.38	1.03	0.794	0.633	0.516
	1.6	1.62	34.2	23.2	15.3	10.5	7.65	5.79	4.53	2.98	2.11	1.57	1.22	0.971	0.791
	2.0	2.01	42.1	28.3	18.6	12.8	9.31	7.04	5.51	3.63	2.57	1.91	1.48	1.18	0.962
	2.6	2.57	53.4	35.6	23.3	16.0	11.6	8.79	6.87	4.53	3.20	2.39	1.85	1.47	1.20
	3.2	3.11	64.1	42.4	27.6	19.0	13.7	10.4	8.12	5.34	3.78	2.82	2.18	1.73	1.41
48.3	1.0	1.17	26.9	19.9	13.8	9.78	7.18	5.47	4.30	2.85	2.02	1.51	1.17	0.934	0.763
	1.6	1.85	42.3	31.1	21.5	15.1	11.1	8.45	6.64	4.40	3.12	2.33	1.81	1.44	1.18
	2.0	2.30	52.2	38.1	26.3	18.5	13.6	10.3	8.11	5.37	3.81	2.84	2.20	1.76	1.43
	2.6	2.95	66.6	48.3	33.1	23.3	17.0	13.0	10.2	6.73	4.78	3.56	2.76	2.20	1.80
	3.2	3.58	80.3	57.9	39.5	27.7	20.2	15.4	12.1	7.99	5.67	4.23	3.28	2.61	2.13
60.3	1.0	1.47	37.0	30.4	23.3	17.4	13.2	10.2	8.08	5.42	3.87	2.91	2.26	1.81	1.48
	1.6	2.33	58.4	47.8	36.5	27.2	20.5	15.9	12.6	8.43	6.02	4.52	3.51	2.81	2.29
	2.0	2.89	72.3	59.1	45.0	33.4	25.2	19.5	15.4	10.3	7.39	5.54	4.30	3.44	2.81
	2.6	3.72	92.7	75.5	57.2	42.4	31.9	24.6	19.5	13.1	9.33	6.99	5.43	4.34	3.55
	3.2	4.53	112	91.2	68.9	50.9	38.2	29.5	23.4	15.6	11.2	8.36	6.49	5.19	4.24
	4.0	5.59	138	111	83.6	61.5	46.1	35.5	28.1	18.8	13.4	10.1	7.81	6.24	5.10
5.0	6.86	168	134	100	73.7	55.1	42.4	33.5	22.4	16.0	12.0	9.29	7.42	6.07	
76.1	1.0	1.86	49.5	43.9	37.1	30.0	23.8	19.0	15.3	10.5	7.57	5.71	4.46	3.58	2.93
	1.6	2.96	78.6	69.5	58.5	47.2	37.4	29.8	24.0	16.4	11.8	8.93	6.97	5.59	4.58
	2.0	3.68	97.8	86.2	72.4	58.3	46.2	36.7	29.6	20.2	14.6	11.0	8.58	6.88	5.64
	2.6	4.74	126	110	92.8	74.5	58.9	46.7	37.7	25.7	18.5	14.0	10.9	8.75	7.17
	3.2	5.79	153	134	112	90.1	71.0	56.4	45.4	30.9	22.3	16.8	13.1	10.5	8.62
	4.0	7.16	189	165	137	110	86.5	68.5	55.1	37.5	27.1	20.4	15.9	12.8	10.4
5.0	8.82	233	202	168	133	104	82.8	66.5	45.2	32.6	24.5	19.1	15.3	12.6	
88.9	1.0	2.18	58.0	54.6	48.2	41.1	34.1	28.0	23.0	16.1	11.7	8.91	6.98	5.62	4.61
	1.6	3.47	92.2	86.5	76.3	64.9	53.8	44.1	36.2	25.3	18.4	14.0	11.0	8.81	7.24
	2.0	4.31	114	107	94.6	80.5	66.6	54.5	44.8	31.2	22.7	17.3	13.5	10.9	8.93
	2.6	5.57	148	138	121	103	85.2	69.7	57.2	39.8	29.0	22.0	17.2	13.9	11.4
	3.2	6.81	180	168	148	125	103	84.4	69.2	48.1	35.0	26.6	20.8	16.7	13.7
	4.0	8.43	224	208	182	154	126	103	84.5	58.7	42.7	32.4	25.4	20.4	16.7
5.0	10.4	276	256	223	188	154	125	102	71.1	51.7	39.2	30.7	24.7	20.2	
101.6	1.6	3.97	105	103	93.5	82.7	71.2	60.3	50.7	36.2	26.7	20.4	16.1	13.0	10.7
	2.0	4.94	131	128	116	102	88.4	74.7	62.7	44.8	33.1	25.3	19.9	16.0	13.2
	2.6	6.39	169	165	149	132	113	95.8	80.4	57.3	42.3	32.3	25.4	20.5	16.9
	3.2	7.81	207	202	182	160	138	116	97.5	69.4	51.2	39.1	30.8	24.8	20.4
	4.0	9.69	257	250	225	198	169	142	119	85.0	62.6	47.8	37.6	30.3	24.9
5.0	12.0	318	308	278	243	208	174	145	103	76.2	58.1	45.7	36.8	30.3	
114.3	1.6	4.48	118	118	110	100	89.0	77.6	66.8	49.1	36.8	28.4	22.5	18.2	15.0
	2.0	5.57	148	148	137	124	110	96.3	82.8	60.9	45.6	35.1	27.8	22.5	18.6
	2.6	7.21	191	191	177	160	142	123	106	78.1	58.5	45.0	35.6	28.8	23.8
	3.2	8.82	234	234	216	196	173	150	129	94.8	71.0	54.6	43.2	35.0	28.8
	4.0	10.9	291	291	268	242	214	185	159	116	87.0	67.0	52.9	42.8	35.3
5.0	13.6	360	360	331	298	263	227	195	142	106	81.7	64.6	52.2	43.1	

Only the sections which are non slender under axial compression are given in the table.

For explanation of table see Section 8.4.

COMPRESSION

CIRCULAR HOLLOW SECTIONS
SUBJECT TO AXIAL COMPRESSION

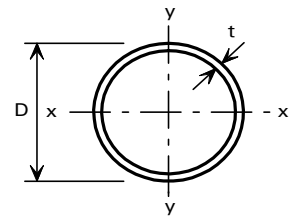

COMPRESSION RESISTANCE FOR GRADE 1.4301 (304)

D mm	t mm	Mass per Metre kg	Compression Resistance P_c (kN)												
			for Effective Length L_e (m)												
			2.0	3.0	4.0	5.0	6.0	7.0	8.0	9.0	10.0	11.0	12.0	13.0	14.0
139.7	1.6	5.48	145	145	143	134	124	113	101	79.8	62.1	48.9	39.2	32.0	26.6
	2.0	6.84	179	154	126	99.1	77.1	60.7	48.6	39.7	32.9	27.8	23.7	20.5	17.8
	2.6	8.85	231	199	162	127	99.1	78.0	62.5	51.0	42.3	35.6	30.4	26.3	22.9
	3.2	10.8	283	243	198	155	120	94.9	76.0	62.0	51.4	43.3	37.0	31.9	27.8
	4.0	13.5	351	302	245	191	148	116	93.5	76.3	63.3	53.3	45.5	39.3	34.2
5.0	16.7	435	373	302	235	182	143	114	93.4	77.5	65.3	55.7	48.1	41.9	
168.3	2.0	8.25	219	202	176	147	120	97.9	80.0	66.1	55.3	46.9	40.2	34.9	30.5
	2.6	10.7	284	262	227	190	155	126	103	85.1	71.3	60.4	51.8	44.9	39.2
	3.2	13.1	348	320	278	233	189	153	125	103	86.9	73.6	63.1	54.7	47.8
	4.0	16.3	433	398	345	288	234	190	155	128	107	90.8	77.8	67.4	58.9
	5.0	20.3	538	494	427	356	289	234	190	157	131	111	95.7	82.9	72.4
219.1	2.6	14.0	371	370	339	305	269	232	198	168	144	124	107	93.9	82.6
	3.2	17.1	455	454	416	374	329	284	242	206	176	151	131	114	100
	4.0	21.4	567	565	518	465	409	352	300	255	218	187	162	141	124
	5.0	26.6	706	702	643	577	507	436	371	315	269	231	200	175	154
	273	3.2	21.4	569	569	558	520	479	434	388	343	302	266	234	207
4.0		26.7	709	709	695	648	596	540	483	427	375	330	290	256	228
5.0		33.3	884	884	865	806	741	671	599	529	465	409	360	318	282

Only the sections which are non slender under axial compression are given in the table.

For explanation of table see Section 8.4.

Table 26

COMPRESSION

**RECTANGULAR HOLLOW SECTIONS
SUBJECT TO AXIAL COMPRESSION**

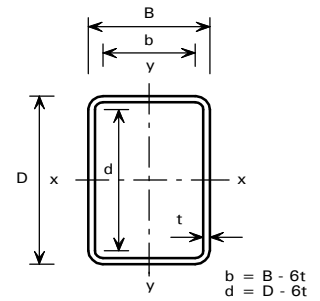

COMPRESSION RESISTANCE FOR GRADE 1.4301 (304)

D x B mm	t mm	Mass per Metre kg	Axis	Compression Resistance, P_{cx} , P_{cy} (kN)												
				for Effective Length L_E (m)												
				1.0	1.5	2.0	2.5	3.0	3.5	4.0	5.0	6.0	7.0	8.0	9.0	10.0
50 x 25	1.5	1.63	P_{cx}	38.3	29.2	20.7	14.8	10.9	8.34	6.56	4.36	3.10	2.32	1.80	1.43	1.17
			P_{cy}	25.3	14.2	8.69	5.82	4.16	3.12	2.42	1.58	1.11	0.827	0.638	0.507	0.413
	2.0	2.11	P_{cx}	49.1	36.9	26.0	18.5	13.6	10.4	8.17	5.42	3.85	2.88	2.23	1.78	1.45
			P_{cy}	31.8	17.6	10.8	7.19	5.14	3.85	2.99	1.95	1.38	1.02	0.787	0.626	0.509
60 x 30	2.0	2.58	P_{cx}	64.9	53.4	41.0	30.6	23.2	17.9	14.2	9.53	6.82	5.11	3.97	3.18	2.60
			P_{cy}	48.1	29.5	18.6	12.6	9.08	6.83	5.33	3.50	2.47	1.84	1.42	1.13	0.919
	3.0	3.68	P_{cx}	91.3	74.0	55.9	41.3	31.1	24.0	19.0	12.7	9.07	6.79	5.28	4.22	3.45
			P_{cy}	65.8	39.4	24.7	16.7	12.0	9.00	7.01	4.60	3.24	2.41	1.86	1.48	1.21
80 x 40	* 2.0	3.53	P_{cx}	91.3	83.7	72.5	60.4	49.1	39.7	32.3	22.3	16.2	12.3	9.60	7.71	6.33
			P_{cy}	79.2	58.9	41.2	29.1	21.4	16.3	12.8	8.51	6.05	4.52	3.50	2.79	2.28
	3.0	5.10	P_{cx}	135	122	104	86.1	69.2	55.6	45.1	31.0	22.4	16.9	13.2	10.6	8.72
			P_{cy}	115	83.5	57.3	40.2	29.5	22.4	17.6	11.6	8.27	6.17	4.78	3.81	3.11
	4.0	6.54	P_{cx}	173	155	131	107	85.5	68.3	55.2	37.8	27.3	20.6	16.1	12.9	10.6
			P_{cy}	145	103	70.0	48.9	35.7	27.1	21.3	14.1	9.98	7.44	5.77	4.60	3.75
100 x 50	* 2.0	4.48	P_{cx}	104	104	95.6	86.1	75.8	65.4	55.9	40.7	30.4	23.3	18.4	14.9	12.3
			P_{cy}	100	85.0	67.3	51.4	39.4	30.7	24.5	16.5	11.8	8.87	6.90	5.52	4.52
	3.0	6.52	P_{cx}	173	169	153	135	116	98.6	82.8	59.1	43.6	33.4	26.3	21.2	17.4
			P_{cy}	162	133	101	75.3	56.7	43.8	34.7	23.3	16.6	12.5	9.69	7.74	6.33
	4.0	8.43	P_{cx}	224	217	196	172	147	124	103	73.9	54.4	41.6	32.7	26.4	21.7
			P_{cy}	208	168	127	93.9	70.5	54.4	43.0	28.8	20.5	15.4	12.0	9.56	7.81
	5.0	10.2	P_{cx}	271	262	235	205	174	146	121	86.3	63.4	48.3	38.0	30.6	25.2
			P_{cy}	250	200	149	109	81.8	63.0	49.8	33.3	23.7	17.8	13.8	11.0	9.01
	6.0	11.9	P_{cx}	315	302	270	234	197	164	136	96.3	70.6	53.8	42.2	34.0	28.0
			P_{cy}	288	227	167	122	90.9	69.8	55.2	36.8	26.2	19.6	15.2	12.2	9.94
150 x 75	* 3.0	10.1	P_{cx}	234	234	234	228	215	201	186	154	125	101	82.8	68.3	57.1
			P_{cy}	234	226	203	178	151	126	105	74.8	55.0	41.9	33.0	26.6	21.9
	4.0	13.2	P_{cx}	350	350	350	332	310	287	262	212	168	134	108	89.2	74.3
			P_{cy}	350	329	291	248	206	169	139	97.5	71.2	54.0	42.4	34.1	28.0
	5.0	16.1	P_{cx}	428	428	428	405	378	349	318	256	202	161	130	106	88.9
			P_{cy}	428	401	353	300	248	203	167	116	84.8	64.3	50.4	40.5	33.3
	6.0	19.0	P_{cx}	504	504	504	474	441	406	369	296	233	185	149	122	101
			P_{cy}	504	469	411	348	286	233	191	132	96.8	73.4	57.5	46.2	38.0
	8.0	24.2	P_{cx}	644	644	640	600	556	509	460	365	286	226	181	148	123
			P_{cy}	644	593	515	430	350	284	231	160	116	88.2	69.0	55.4	45.5
150 x 100	* 3.0	11.3	P_{cx}	266	266	266	261	247	232	215	181	149	121	99.4	82.3	68.9
			P_{cy}	266	266	255	235	213	189	166	126	96.2	74.8	59.5	48.3	40.0
	4.0	14.8	P_{cx}	392	392	392	377	354	329	303	249	201	161	131	107	90.0
			P_{cy}	392	392	367	334	299	262	226	168	126	97.6	77.3	62.7	51.8
	5.0	18.1	P_{cx}	481	481	481	461	433	402	369	303	243	194	157	129	108
			P_{cy}	481	481	449	408	363	317	274	202	152	117	92.9	75.2	62.1
	6.0	21.3	P_{cx}	567	567	567	542	508	471	432	352	281	225	182	149	125
			P_{cy}	567	567	526	477	424	369	318	234	175	135	106	86.6	71.5
	8.0	27.4	P_{cx}	728	728	728	690	645	596	544	440	349	278	224	184	153
			P_{cy}	728	728	669	604	533	461	395	288	215	165	130	105	87.4

* Section is slender under axial compression and allowance has been made in calculating the compression resistance.

For explanation of table see Section 8.4.

Table 26

COMPRESSION

**RECTANGULAR HOLLOW SECTIONS
SUBJECT TO AXIAL COMPRESSION**

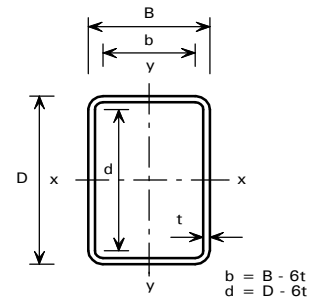

COMPRESSION RESISTANCE FOR GRADE 1.4301 (304)

D x B mm	t mm	Mass per Metre kg	Axis	Compression Resistance, P_{cx} , P_{cy} (kN)												
				for Effective Length L_E (m)												
				1.0	1.5	2.0	2.5	3.0	3.5	4.0	5.0	6.0	7.0	8.0	9.0	10.0
200 x 100	* 4.0	17.9	P_{cx}	417	417	417	417	416	399	382	344	303	261	223	190	162
			P_{cy}	417	417	403	372	339	304	269	205	157	122	97.8	79.6	65.9
	* 5.0	22.1	P_{cx}	570	570	570	570	560	536	509	453	392	333	281	237	202
			P_{cy}	570	570	540	495	445	394	343	257	194	150	119	97.1	80.2
	6.0	26.1	P_{cx}	693	693	693	693	677	646	613	541	466	394	331	278	236
			P_{cy}	693	693	651	594	532	467	405	301	226	175	138	112	93.1
	8.0	33.7	P_{cx}	896	896	896	896	870	829	785	690	590	496	415	349	295
			P_{cy}	896	896	835	759	675	590	509	375	281	217	172	139	115
	10.0	40.8	P_{cx}	1090	1090	1090	1090	1050	996	941	822	699	585	487	408	345
			P_{cy}	1090	1090	1000	906	802	696	597	437	327	251	199	161	133
200 x 125	* 4.0	19.5	P_{cx}	459	459	459	459	459	443	425	385	341	296	254	218	187
			P_{cy}	459	459	459	440	413	384	353	289	232	186	151	124	103
	* 5.0	24.0	P_{cx}	622	622	622	622	617	591	564	505	441	378	321	273	232
			P_{cy}	622	622	622	587	547	504	459	369	291	231	186	153	127
	6.0	28.5	P_{cx}	756	756	756	756	745	713	679	605	526	448	379	321	273
			P_{cy}	756	756	754	707	657	603	547	436	342	271	218	178	148
	8.0	36.9	P_{cx}	980	980	980	980	962	919	874	775	670	569	479	405	343
			P_{cy}	980	980	973	911	844	772	697	552	431	340	273	223	185
	10.0	44.8	P_{cx}	1190	1190	1190	1190	1160	1110	1050	929	799	675	567	477	404
			P_{cy}	1190	1190	1180	1100	1010	924	831	653	508	400	320	261	217
250 x 125	* 6.0	33.2	P_{cx}	841	841	841	841	841	841	816	756	690	621	550	483	422
			P_{cy}	841	841	841	800	748	692	633	513	408	326	263	216	180
	8.0	43.2	P_{cx}	1150	1150	1150	1150	1150	1140	1100	1010	919	819	720	627	545
			P_{cy}	1150	1150	1150	1080	1000	920	835	667	525	416	335	274	228
	10.0	52.7	P_{cx}	1400	1400	1400	1400	1400	1390	1340	1230	1110	985	862	749	649
			P_{cy}	1400	1400	1390	1310	1210	1110	1000	795	623	492	395	323	268
	12.0	61.7	P_{cx}	1640	1640	1640	1640	1640	1610	1550	1420	1280	1130	989	856	741
			P_{cy}	1640	1640	1620	1520	1400	1280	1150	907	707	557	447	365	303
	15.0	74.1	P_{cx}	1970	1970	1970	1970	1970	1930	1850	1690	1510	1330	1150	991	854
			P_{cy}	1970	1970	1930	1800	1660	1500	1350	1050	811	636	509	415	344
250 x 150	* 6.0	35.6	P_{cx}	904	904	904	904	904	883	821	754	681	607	535	470	
			P_{cy}	904	904	904	901	857	810	760	652	544	449	370	308	259
	8.0	46.4	P_{cx}	1230	1230	1230	1230	1230	1230	1190	1100	1010	902	797	698	610
			P_{cy}	1230	1230	1230	1220	1150	1090	1010	859	709	580	476	394	331
	10.0	56.6	P_{cx}	1510	1510	1510	1510	1510	1500	1450	1340	1220	1090	959	838	730
			P_{cy}	1510	1510	1510	1480	1400	1320	1230	1030	849	692	567	469	393
	12.0	66.4	P_{cx}	1770	1770	1770	1770	1770	1750	1690	1560	1410	1260	1110	963	837
			P_{cy}	1770	1770	1770	1730	1630	1530	1420	1190	974	791	646	534	447
	15.0	80.1	P_{cx}	2130	2130	2130	2130	2130	2100	2020	1860	1680	1480	1300	1120	973
			P_{cy}	2130	2130	2130	2070	1950	1820	1680	1400	1140	917	746	616	515

* Section is slender under axial compression and allowance has been made in calculating the compression resistance.

For explanation of table see Section 8.4.

Table 26

COMPRESSION

**RECTANGULAR HOLLOW SECTIONS
SUBJECT TO AXIAL COMPRESSION**

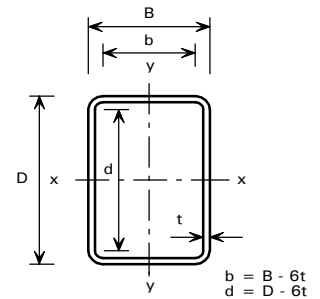

COMPRESSION RESISTANCE FOR GRADE 1.4301 (304)

D x B mm	t mm	Mass per Metre kg	Axis	Compression Resistance, P_{cx} , P_{cy} (kN)												
				for Effective Length L_E (m)												
				2.0	3.0	4.0	5.0	6.0	7.0	8.0	9.0	10.0	11.0	12.0	13.0	14.0
300 x 150	* 6.0	40.3	P_{cx}	938	938	938	912	860	804	744	682	619	559	503	452	406
			P_{cy}	938	906	814	712	605	507	422	354	299	255	220	191	167
	8.0	52.7	P_{cx}	1400	1400	1400	1330	1240	1150	1050	948	849	758	675	602	538
			P_{cy}	1400	1320	1170	994	826	678	558	464	390	331	284	247	216
	10.0	64.5	P_{cx}	1720	1720	1720	1620	1510	1400	1270	1150	1030	912	811	723	645
			P_{cy}	1720	1610	1410	1200	993	813	668	554	465	395	339	294	257
	12.0	75.9	P_{cx}	2020	2020	2020	1900	1770	1630	1480	1330	1190	1050	935	832	742
			P_{cy}	2020	1880	1650	1390	1150	934	765	634	531	451	387	335	293
	15.0	91.9	P_{cx}	2440	2440	2430	2280	2120	1940	1760	1570	1400	1240	1100	974	868
			P_{cy}	2440	2260	1960	1650	1340	1090	891	736	616	522	448	388	339
300 x 200	* 6.0	45.0	P_{cx}	1060	1060	1060	1040	988	928	863	796	727	660	596	538	485
			P_{cy}	1060	1060	1020	940	852	759	667	581	505	439	384	338	299
	8.0	59.0	P_{cx}	1570	1570	1570	1510	1420	1320	1220	1110	999	897	804	720	645
			P_{cy}	1570	1570	1470	1340	1200	1050	907	780	672	581	505	442	390
	10.0	72.4	P_{cx}	1930	1930	1930	1850	1730	1610	1480	1350	1210	1090	972	869	779
			P_{cy}	1930	1930	1800	1630	1450	1270	1100	942	810	699	608	532	469
	12.0	85.4	P_{cx}	2270	2270	2270	2170	2030	1890	1730	1570	1410	1260	1130	1010	901
			P_{cy}	2270	2270	2110	1910	1700	1480	1270	1090	936	807	701	613	540
	15.0	103	P_{cx}	2760	2760	2760	2620	2450	2270	2070	1870	1680	1500	1340	1190	1070
			P_{cy}	2760	2760	2540	2300	2030	1760	1510	1290	1100	950	825	721	634
350 x 175	* 6.0	47.4	P_{cx}	1030	1030	1030	1030	1000	956	906	854	799	743	687	632	579
			P_{cy}	1030	1030	965	880	788	692	599	516	445	385	335	293	259
	* 8.0	62.2	P_{cx}	1540	1540	1540	1540	1470	1390	1310	1220	1130	1040	950	865	787
			P_{cy}	1540	1540	1410	1260	1110	955	814	692	591	508	440	384	338
	10.0	76.4	P_{cx}	2030	2030	2030	2010	1910	1800	1680	1560	1430	1310	1190	1080	974
			P_{cy}	2030	2000	1820	1620	1400	1190	1010	850	722	619	535	466	409
	12.0	90.1	P_{cx}	2400	2400	2400	2360	2240	2110	1970	1820	1670	1520	1380	1250	1130
			P_{cy}	2400	2350	2130	1890	1630	1380	1160	982	833	713	616	537	471
	15.0	109	P_{cx}	2920	2920	2920	2860	2710	2550	2370	2190	2000	1820	1640	1480	1340
			P_{cy}	2920	2840	2570	2270	1950	1640	1380	1160	981	838	723	629	552
350 x 200	* 6.0	49.8	P_{cx}	1090	1090	1090	1090	1070	1020	968	914	857	798	739	681	626
			P_{cy}	1090	1090	1060	986	903	814	724	637	558	489	429	379	336
	* 8.0	65.3	P_{cx}	1630	1630	1630	1630	1560	1480	1390	1300	1210	1120	1020	933	851
			P_{cy}	1630	1630	1550	1420	1280	1140	997	865	750	651	569	499	441
	10.0	80.3	P_{cx}	2140	2140	2140	2130	2020	1910	1790	1660	1540	1410	1280	1160	1060
			P_{cy}	2140	2140	2000	1830	1640	1440	1240	1070	923	799	695	609	537
	12.0	94.8	P_{cx}	2520	2520	2520	2500	2380	2240	2100	1950	1800	1640	1490	1350	1230
			P_{cy}	2520	2520	2360	2140	1910	1680	1450	1240	1070	925	804	704	621
	15.0	115	P_{cx}	3070	3070	3070	3040	2880	2710	2540	2350	2160	1970	1780	1610	1460
			P_{cy}	3070	3070	2850	2590	2300	2000	1720	1480	1270	1090	950	831	732

* Section is slender under axial compression and allowance has been made in calculating the compression resistance.

For explanation of table see Section 8.4.

Table 26

COMPRESSION

**RECTANGULAR HOLLOW SECTIONS
SUBJECT TO AXIAL COMPRESSION**

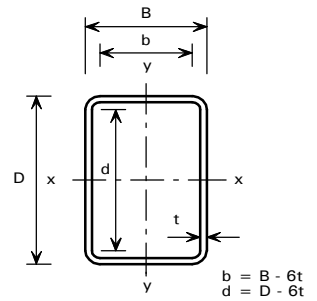

COMPRESSION RESISTANCE FOR GRADE 1.4301 (304)

D x B mm	t mm	Mass per Metre kg	Axis	Compression Resistance, P_{cx} , P_{cy} (kN)												
				for Effective Length L_E (m)												
				2.0	3.0	4.0	5.0	6.0	7.0	8.0	9.0	10.0	11.0	12.0	13.0	14.0
400 x 200	* 6.0	54.5	P_{cx}	1110	1110	1110	1110	1110	1090	1050	1000	955	906	856	804	753
			P_{cy}	1110	1110	1100	1020	945	861	773	687	607	535	472	418	371
	* 8.0	71.6	P_{cx}	1670	1670	1670	1670	1670	1600	1530	1460	1380	1300	1210	1130	1050
			P_{cy}	1670	1670	1610	1490	1360	1220	1080	943	823	718	629	554	490
	* 10.0	88.2	P_{cx}	2280	2280	2280	2280	2240	2140	2040	1930	1810	1690	1570	1450	1340
			P_{cy}	2280	2280	2160	1980	1780	1580	1370	1190	1030	892	778	682	602
	12.0	104	P_{cx}	2770	2770	2770	2770	2710	2590	2450	2310	2170	2020	1870	1720	1580
			P_{cy}	2770	2770	2610	2380	2130	1870	1620	1400	1200	1040	907	795	701
	15.0	127	P_{cx}	3390	3390	3390	3390	3300	3140	2980	2800	2620	2430	2240	2060	1890
			P_{cy}	3390	3390	3160	2880	2570	2240	1940	1670	1430	1240	1080	942	830
400 x 250	* 6.0	59.3	P_{cx}	1200	1200	1200	1200	1200	1180	1140	1090	1050	997	946	893	839
			P_{cy}	1200	1200	1200	1180	1110	1050	975	900	823	748	677	611	552
	* 8.0	78.0	P_{cx}	1840	1840	1840	1840	1840	1770	1700	1620	1540	1450	1370	1280	1190
			P_{cy}	1840	1840	1840	1760	1660	1540	1410	1290	1160	1040	930	832	746
	* 10.0	96.1	P_{cx}	2490	2490	2490	2490	2470	2370	2260	2140	2020	1900	1770	1640	1520
			P_{cy}	2490	2490	2490	2350	2190	2020	1840	1650	1480	1310	1170	1040	926
	12.0	113	P_{cx}	3030	3030	3030	3030	2980	2850	2720	2570	2420	2260	2100	1950	1800
			P_{cy}	3030	3030	3020	2830	2630	2420	2190	1960	1750	1550	1370	1220	1090
	15.0	139	P_{cx}	3700	3700	3700	3700	3640	3480	3310	3130	2940	2740	2540	2350	2160
			P_{cy}	3700	3700	3680	3450	3200	2930	2650	2360	2100	1860	1640	1460	1300

* Section is slender under axial compression and allowance has been made in calculating the compression resistance.

For explanation of table see Section 8.4.

Table 27

COMPRESSION

**SQUARE HOLLOW SECTIONS
SUBJECT TO AXIAL COMPRESSION**

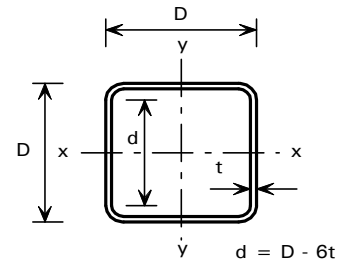

COMPRESSION RESISTANCE FOR GRADE 1.4301 (304)

D x D mm	t mm	Mass per Metre kg	Compression Resistance P_c (kN)												
			for Effective Length L_e (m)												
			1.0	1.5	2.0	2.5	3.0	3.5	4.0	5.0	6.0	7.0	8.0	9.0	10.0
40 x 40	2.0	2.27	49.5	34.6	23.2	16.2	11.8	8.93	7.00	4.62	3.27	2.44	1.89	1.51	1.23
	3.0	3.20	68.2	46.6	30.8	21.3	15.5	11.7	9.18	6.06	4.29	3.20	2.47	1.97	1.61
50 x 50	2.0	2.90	70.8	56.3	41.6	30.4	22.7	17.4	13.8	9.19	6.56	4.91	3.81	3.04	2.49
	3.0	4.15	100	78.6	57.3	41.5	30.9	23.7	18.7	12.5	8.87	6.64	5.15	4.11	3.36
	4.0	5.27	125	96.9	69.7	50.1	37.1	28.4	22.4	14.9	10.6	7.92	6.15	4.91	4.01
60 x 60	2.0	3.53	91.6	78.2	62.9	48.7	37.6	29.4	23.5	15.9	11.4	8.57	6.67	5.34	4.37
	3.0	5.10	131	111	88.7	68.1	52.3	40.8	32.5	21.9	15.7	11.8	9.21	7.37	6.03
	4.0	6.54	167	140	110	84.2	64.3	50.1	39.9	26.8	19.2	14.4	11.2	8.99	7.35
	5.0	7.84	198	165	128	97.2	73.8	57.3	45.6	30.6	21.9	16.4	12.8	10.2	8.36
80 x 80	* 2.0	4.79	122	116	103	89.4	75.0	62.1	51.4	36.1	26.4	20.1	15.8	12.7	10.4
	3.0	6.99	185	174	154	131	109	89.6	73.8	51.4	37.5	28.5	22.3	18.0	14.8
	4.0	9.06	240	225	197	167	138	113	92.9	64.6	47.1	35.7	28.0	22.5	18.5
	5.0	11.0	292	271	237	200	164	133	109	75.9	55.2	41.8	32.8	26.3	21.6
100 x 100	3.0	8.89	236	236	218	197	174	151	130	95.3	71.3	54.9	43.4	35.1	29.0
	4.0	11.6	308	308	283	255	225	194	166	121	90.7	69.8	55.1	44.6	36.8
	5.0	14.2	376	375	343	309	271	234	199	145	108	83.1	65.6	53.0	43.7
	6.0	16.6	441	438	400	359	314	269	229	166	123	94.8	74.8	60.4	49.8
	8.0	21.1	560	551	502	446	387	330	278	200	148	113	89.5	72.3	59.5
125 x 125	* 3.0	11.3	279	279	278	261	243	223	202	161	127	100	81.3	66.5	55.3
	4.0	14.8	392	392	387	361	334	304	273	215	167	131	105	86.2	71.6
	5.0	18.1	481	481	473	442	407	370	332	260	202	158	127	103	86.1
	6.0	21.3	567	567	556	518	477	433	387	302	233	183	146	119	99.4
	8.0	27.4	728	728	710	659	604	546	486	375	289	226	180	147	122
150 x 150	* 3.0	13.6	296	296	296	296	283	269	253	220	186	154	128	107	90.7
	4.0	17.9	476	476	476	465	440	413	383	322	263	214	175	144	121
	5.0	22.1	586	586	586	572	540	506	469	393	320	260	212	175	146
	6.0	26.1	693	693	693	675	636	595	552	460	374	303	247	204	170
	8.0	33.7	896	896	896	868	817	762	704	583	472	380	309	255	213

* Section is slender under axial compression and allowance has been made in calculating the compression resistance.

For explanation of table see Section 8.4.

Table 27

COMPRESSION

**SQUARE HOLLOW SECTIONS
SUBJECT TO AXIAL COMPRESSION**

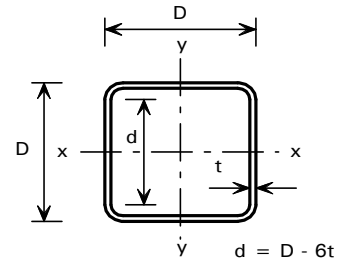

COMPRESSION RESISTANCE FOR GRADE 1.4301 (304)

D x D mm	t mm	Mass per Metre kg	Compression Resistance P_c (kN)												
			for Effective Length L_e (m)												
			2.0	3.0	4.0	5.0	6.0	7.0	8.0	9.0	10.0	11.0	12.0	13.0	14.0
175 x 175	* 4.0	21.1	504	497	453	403	350	299	253	214	182	156	135	117	103
	5.0	26.0	691	671	604	531	454	381	319	267	226	193	166	145	127
	6.0	30.8	819	793	714	625	533	447	373	313	265	226	195	169	148
	8.0	40.0	1060	1030	920	802	681	569	474	396	335	285	246	214	187
	10.0	48.7	1300	1240	1110	964	814	677	562	469	396	337	290	252	221
200 x 200	* 4.0	24.2	526	526	504	465	422	376	331	288	250	218	191	168	148
	* 5.0	30.0	764	764	712	647	577	504	435	373	321	277	241	211	186
	6.0	35.6	945	945	872	789	698	606	520	444	381	328	285	249	219
	8.0	46.4	1230	1230	1130	1020	900	778	666	568	486	418	362	317	279
	10.0	56.6	1510	1500	1380	1240	1090	936	798	679	580	499	432	377	332
250 x 250	* 5.0	37.9	822	822	822	788	740	687	631	574	517	463	414	370	332
	* 6.0	45.0	1120	1120	1110	1050	973	894	811	727	647	574	509	452	403
	8.0	59.0	1570	1570	1550	1450	1340	1220	1090	973	860	758	669	592	527
	10.0	72.4	1930	1930	1900	1770	1630	1480	1330	1180	1040	916	808	714	635
	12.0	85.4	2270	2270	2230	2080	1910	1730	1550	1370	1210	1060	935	826	734
300 x 300	* 5.0	45.8	864	864	864	864	846	808	767	724	679	633	586	540	496
	* 6.0	54.5	1180	1180	1180	1180	1140	1080	1020	950	882	812	745	680	619
	8.0	71.6	1900	1900	1900	1860	1760	1650	1540	1410	1290	1170	1050	950	856
	10.0	88.2	2350	2350	2350	2290	2160	2030	1880	1730	1570	1420	1280	1160	1040
	12.0	104	2770	2770	2770	2700	2550	2380	2210	2030	1840	1660	1500	1350	1210
350 x 350	* 6.0	64.0	1240	1240	1240	1240	1240	1210	1160	1110	1060	1000	944	886	828
	* 8.0	84.3	2020	2020	2020	2020	1990	1900	1810	1720	1620	1510	1400	1300	1200
	10.0	104	2770	2770	2770	2770	2680	2560	2420	2280	2120	1970	1820	1670	1530
	12.0	123	3280	3280	3280	3280	3170	3020	2860	2680	2500	2320	2130	1960	1790
	15.0	151	4020	4020	4020	4020	3880	3690	3480	3270	3040	2810	2580	2370	2160
400 x 400	* 6.0	73.5	1280	1280	1280	1280	1280	1280	1260	1230	1180	1140	1100	1050	1000
	* 8.0	96.9	2110	2110	2110	2110	2110	2090	2020	1940	1860	1780	1690	1600	1510
	* 10.0	119	3060	3060	3060	3060	3060	2970	2850	2720	2590	2450	2310	2160	2020
	12.0	142	3780	3780	3780	3780	3780	3650	3490	3330	3160	2980	2790	2610	2430
	15.0	174	4650	4650	4650	4650	4650	4470	4280	4070	3860	3640	3410	3180	2950

* Section is slender under axial compression and allowance has been made in calculating the compression resistance.

For explanation of table see Section 8.4.

Table 28

COMPRESSION

CHANNELS
SUBJECT TO AXIAL COMPRESSION

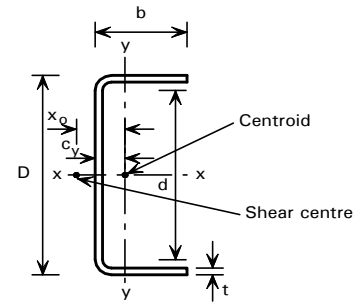

COMPRESSION RESISTANCE FOR GRADE 1.4301 (304)

D x b mm	t mm	Mass per Metre kg	Axis	Compression Resistance, P _{cx} , P _{cxz} , P _{cy} (kN)												
				for Effective Length L _E (m)												
				1.0	1.5	2.0	2.5	3.0	3.5	4.0	5.0	6.0	7.0	8.0	9.0	10.0
50 x 25	* 2.0	1.45	P _{cx}	35.3	28.1	20.8	15.2	11.3	8.72	6.89	4.60	3.28	2.45	1.91	1.52	1.24
			P _{cxz}	21.6	17.9	14.9	12.1	9.76	7.88	6.43	4.44	3.23	2.44	1.90	1.53	1.25
			P _{cy}	15.4	7.85	4.67	3.09	2.19	1.63	1.27	0.823	0.578	0.428	0.329	0.262	0.213
	3.0	2.08	P _{cx}	50.1	39.3	28.7	20.8	15.4	11.8	9.35	6.23	4.44	3.32	2.58	2.06	1.68
			P _{cxz}	39.2	32.9	25.7	19.6	15.0	11.7	9.32	6.28	4.49	3.37	2.62	2.09	1.71
			P _{cy}	21.4	10.9	6.47	4.27	3.03	2.26	1.75	1.14	0.798	0.591	0.455	0.361	0.294
75 x 35	3.0	3.14	P _{cx}	83.5	76.4	66.1	54.9	44.5	36.0	29.3	20.2	14.7	11.1	8.68	6.97	5.72
			P _{cxz}	56.4	48.1	42.7	38.1	33.5	29.1	25.0	18.5	14.0	10.8	8.55	6.92	5.71
			P _{cy}	51.6	29.6	18.2	12.2	8.77	6.58	5.12	3.35	2.36	1.75	1.35	1.08	0.875
	4.0	4.06	P _{cx}	107	97.9	84.1	69.5	56.0	45.1	36.6	25.2	18.3	13.8	10.8	8.66	7.11
			P _{cxz}	81.6	74.3	66.9	58.4	49.5	41.5	34.6	24.6	18.2	13.9	10.9	8.76	7.20
			P _{cy}	65.7	37.4	23.0	15.5	11.1	8.29	6.45	4.22	2.97	2.21	1.70	1.35	1.10
	5.0	4.91	P _{cx}	130	117	100	82.1	65.8	52.8	42.8	29.3	21.2	16.0	12.5	10.1	8.25
			P _{cxz}	106	98.3	87.8	75.1	62.3	51.2	42.2	29.5	21.5	16.3	12.8	10.3	8.41
			P _{cy}	78.3	44.3	27.2	18.2	13.0	9.78	7.61	4.97	3.50	2.60	2.01	1.60	1.30
100 x 50	* 3.0	4.45	P _{cx}	107	107	101	92.2	82.5	72.4	62.7	46.6	35.1	27.1	21.5	17.4	14.4
			P _{cxz}	80.3	63.5	52.5	45.7	41.1	37.6	34.7	29.8	25.4	21.4	18.1	15.3	13.0
			P _{cy}	92.4	67.7	46.8	33.0	24.2	18.4	14.5	9.57	6.80	5.08	3.93	3.14	2.56
	* 4.0	5.80	P _{cx}	153	153	141	127	112	97.3	83.2	60.8	45.4	34.9	27.6	22.3	18.4
			P _{cxz}	116	98.0	86.3	78.2	71.5	65.4	59.5	48.5	39.0	31.5	25.7	21.2	17.8
			P _{cy}	128	91.0	61.6	43.0	31.4	23.8	18.7	12.4	8.76	6.53	5.06	4.03	3.29
	5.0	7.08	P _{cx}	188	187	171	154	135	117	99.8	72.6	54.1	41.5	32.8	26.5	21.9
			P _{cxz}	148	132	121	112	102	92.8	82.8	64.6	50.4	39.8	32.0	26.1	21.7
			P _{cy}	155	110	74.2	51.7	37.7	28.6	22.5	14.8	10.5	7.85	6.08	4.84	3.95
125 x 50	* 3.0	5.04	P _{cx}	118	118	118	110	103	94.6	85.7	68.3	53.7	42.5	34.2	28.0	23.3
			P _{cxz}	93.2	74.8	61.1	52.4	46.7	42.8	39.9	35.6	32.1	28.9	25.7	22.6	19.8
			P _{cy}	101	73.6	50.6	35.6	26.1	19.8	15.6	10.3	7.32	5.46	4.23	3.38	2.76
	* 4.0	6.59	P _{cx}	174	174	171	159	146	132	118	92.0	71.1	55.7	44.6	36.3	30.1
			P _{cxz}	136	114	99.2	89.5	82.8	77.5	72.9	64.2	55.5	47.1	39.7	33.5	28.5
			P _{cy}	143	100	67.3	46.8	34.1	25.9	20.3	13.4	9.48	7.07	5.47	4.36	3.56
	5.0	8.07	P _{cx}	214	214	209	194	178	161	143	110	85.5	66.9	53.4	43.5	36.1
			P _{cxz}	172	152	139	130	123	115	108	92.0	75.9	62.1	51.0	42.3	35.5
			P _{cy}	175	121	81.4	56.5	41.1	31.2	24.4	16.1	11.4	8.52	6.60	5.26	4.29
	6.0	9.49	P _{cx}	252	252	245	227	208	187	166	128	98.4	76.9	61.4	50.0	41.4
			P _{cxz}	208	192	181	172	163	153	141	115	93.0	74.7	60.6	49.8	41.6
			P _{cy}	204	141	94.4	65.4	47.6	36.1	28.3	18.7	13.2	9.85	7.63	6.08	4.96
150 x 60	* 4.0	8.01	P _{cx}	202	202	202	197	186	174	162	135	111	90.1	73.6	60.8	50.9
			P _{cxz}	168	141	118	102	92.2	84.6	79.0	70.9	64.5	58.7	53.0	47.4	42.1
			P _{cy}	183	144	105	76.6	57.0	43.7	34.5	23.0	16.4	12.3	9.51	7.60	6.21
	5.0	9.85	P _{cx}	261	261	261	253	238	222	205	169	137	110	89.9	74.1	61.9
			P _{cxz}	217	188	165	149	138	130	123	111	99.4	87.5	76.0	65.7	56.7
			P _{cy}	234	181	130	94.2	69.8	53.4	42.1	28.0	19.9	14.9	11.6	9.24	7.54
	6.0	11.6	P _{cx}	308	308	308	297	280	260	240	198	159	128	104	85.9	71.7
			P _{cxz}	259	232	212	198	188	179	170	152	132	113	95.6	81.0	69.0
			P _{cy}	276	213	152	109	81.3	62.3	49.1	32.6	23.2	17.4	13.5	10.8	8.78
	8.0	15.0	P _{cx}	397	397	397	381	357	331	304	249	199	159	129	106	88.8
			P _{cxz}	344	323	309	298	287	274	259	223	186	154	127	105	89.1
			P _{cy}	353	270	193	138	102	78.2	61.6	40.9	29.1	21.8	16.9	13.5	11.0

See Section 8.4.2 for guidance on calculating an effective length which allows for both the effects of end fixity and nominal end moments due to eccentricity of connection.

Slender sections must also be checked for the combined effects of the axial load and moment caused by the shift of neutral axis, see Section 8.4.2.

* Section is slender under axial compression and allowance has been made in calculating the compression resistance.

For explanation of table see Section 8.4

Table 28

COMPRESSION

CHANNELS
SUBJECT TO AXIAL COMPRESSION

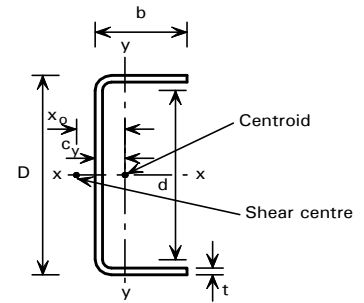

COMPRESSION RESISTANCE FOR GRADE 1.4301 (304)

D x b mm	t mm	Mass per Metre kg	Axis	Compression Resistance, P_{cx} , P_{czz} , P_{cy} (kN)												
				for Effective Length L_E (m)												
				1.0	1.5	2.0	2.5	3.0	3.5	4.0	5.0	6.0	7.0	8.0	9.0	10.0
175 x 60	5.0	10.8	P_{cx}	287	287	287	287	274	260	245	211	178	147	122	102	86.1
			P_{czz}	242	209	181	161	148	138	131	120	112	103	94.1	84.4	75.0
			P_{cy}	255	195	139	99.8	73.7	56.4	44.4	29.5	21.0	15.7	12.2	9.71	7.93
	6.0	12.8	P_{cx}	340	340	340	340	323	306	288	248	208	172	142	118	100
			P_{czz}	289	256	232	214	202	193	185	172	157	141	124	108	94.0
			P_{cy}	301	229	163	116	86.1	65.8	51.8	34.4	24.5	18.3	14.2	11.3	9.25
	8.0	16.5	P_{cx}	439	439	439	437	416	393	368	315	263	216	178	148	125
			P_{czz}	381	355	338	326	316	306	296	270	237	203	172	146	124
			P_{cy}	387	292	206	147	108	83.0	65.3	43.3	30.8	23.0	17.9	14.3	11.6
	10.0	20.0	P_{cx}	532	532	532	526	499	471	440	375	310	254	209	173	145
			P_{czz}	473	453	441	431	421	408	391	348	298	250	209	175	148
			P_{cy}	465	349	245	174	128	98.0	77.1	51.1	36.4	27.2	21.1	16.8	13.7
200 x 75	* 5.0	13.0	P_{cx}	320	320	320	320	320	309	296	268	237	206	177	151	129
			P_{czz}	285	253	220	192	170	154	142	126	115	107	100	94.5	88.2
			P_{cy}	313	268	216	168	129	101	81.3	55.0	39.5	29.7	23.1	18.5	15.2
	* 6.0	15.4	P_{cx}	409	409	409	409	406	389	371	333	292	250	213	181	154
			P_{czz}	361	321	284	254	231	214	201	183	170	158	146	134	122
			P_{cy}	395	333	264	202	155	120	96.4	65.0	46.6	35.0	27.2	21.8	17.8
	8.0	20.0	P_{cx}	532	532	532	532	526	504	480	429	374	320	271	230	195
			P_{czz}	473	432	400	376	358	343	331	309	286	260	233	205	180
			P_{cy}	512	431	340	259	198	154	122	82.7	59.3	44.5	34.6	27.7	22.7
	10.0	24.4	P_{cx}	647	647	647	647	638	610	580	516	448	382	322	272	232
			P_{czz}	581	545	520	502	488	475	462	431	391	347	302	261	226
			P_{cy}	622	521	409	310	236	184	146	98.7	70.7	53.1	41.3	33.0	27.0
225 x 75	* 6.0	16.6	P_{cx}	440	440	440	440	440	432	415	380	341	300	261	226	195
			P_{czz}	392	349	308	272	246	226	211	191	178	167	158	149	140
			P_{cy}	423	355	279	212	162	126	100	67.6	48.4	36.4	28.3	22.6	18.5
	8.0	21.6	P_{cx}	574	574	574	574	574	561	539	491	440	386	334	288	248
			P_{czz}	513	468	430	401	379	363	350	329	311	292	270	246	221
			P_{cy}	550	459	359	272	207	161	128	86.2	61.8	46.4	36.1	28.8	23.6
	10.0	26.3	P_{cx}	700	700	700	700	700	681	653	594	530	463	400	344	295
			P_{czz}	630	588	558	536	520	507	496	472	443	406	365	323	284
			P_{cy}	668	556	433	327	248	193	153	103	73.8	55.4	43.1	34.5	28.2
	12.0	30.8	P_{cx}	819	819	819	819	819	793	760	689	612	533	459	393	337
			P_{czz}	744	708	685	669	656	644	632	599	554	499	440	385	335
			P_{cy}	779	646	501	377	285	221	176	118	84.6	63.5	49.4	39.5	32.3
250 x 100	* 6.0	20.2	P_{cx}	474	474	474	474	474	474	472	443	412	378	342	307	273
			P_{czz}	444	410	372	334	299	268	244	209	186	171	159	150	142
			P_{cy}	474	452	404	349	294	244	202	142	104	79.4	62.3	50.2	41.2
	* 8.0	26.3	P_{cx}	699	699	699	699	699	699	684	637	585	530	473	418	368
			P_{czz}	648	597	545	497	456	423	396	358	331	310	291	274	256
			P_{cy}	699	653	573	486	401	327	269	187	136	103	81.0	65.1	53.5
	10.0	32.3	P_{cx}	857	857	857	857	857	857	836	777	713	644	573	505	443
			P_{czz}	795	739	688	645	610	582	559	523	493	463	433	401	368
			P_{cy}	857	799	700	591	486	397	325	225	164	124	97.7	78.6	64.5
	12.0	37.9	P_{cx}	1010	1010	1010	1010	1010	1010	980	909	832	749	665	585	512
			P_{czz}	936	879	833	797	769	746	726	690	654	612	564	514	463
			P_{cy}	1010	936	818	690	566	461	377	261	190	144	113	90.9	74.6

See Section 8.4.2 for guidance on calculating an effective length which allows for both the effects of end fixity and nominal end moments due to eccentricity of connection.

Slender sections must also be checked for the combined effects of the axial load and moment caused by the shift of neutral axis, see Section 8.4.2.

* Section is slender under axial compression and allowance has been made in calculating the compression resistance.

For explanation of table see Section 8.4

Table 28

COMPRESSION

**CHANNELS
SUBJECT TO AXIAL COMPRESSION**

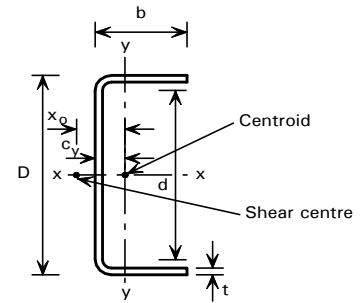

COMPRESSION RESISTANCE FOR GRADE 1.4301 (304)

D x b mm	t mm	Mass per Metre kg	Axis	Compression Resistance, P_{cx} , P_{czz} , P_{cy} (kN)												
				for Effective Length L_E (m)												
				1.0	1.5	2.0	2.5	3.0	3.5	4.0	5.0	6.0	7.0	8.0	9.0	10.0
300 x 100	* 8.0	29.5	P_{cx}	783	783	783	783	783	783	783	754	708	659	607	553	499
			P_{czz}	733	679	621	565	514	472	437	388	356	333	316	302	290
			P_{cy}	783	724	631	530	434	352	288	199	145	109	86.1	69.2	56.8
	10.0	36.2	P_{cx}	962	962	962	962	962	962	962	923	866	805	739	672	606
			P_{czz}	901	839	779	725	680	643	613	569	538	514	492	471	448
			P_{cy}	962	888	772	646	527	427	349	241	175	132	104	83.6	68.6
	12.0	42.7	P_{cx}	1130	1130	1130	1130	1130	1130	1130	1080	1020	942	864	784	705
			P_{czz}	1060	996	939	891	854	824	800	763	733	705	674	639	599
			P_{cy}	1130	1040	905	755	615	498	406	280	203	154	120	97.0	79.6
	15.0	51.9	P_{cx}	1380	1380	1380	1380	1380	1380	1380	1310	1230	1130	1040	936	839
			P_{czz}	1290	1230	1180	1140	1120	1100	1080	1050	1010	970	916	852	783
			P_{cy}	1380	1260	1090	907	736	594	484	333	242	183	143	115	94.6
350 x 125	* 8.0	35.8	P_{cx}	842	842	842	842	842	842	842	822	822	784	744	701	656
			P_{czz}	816	772	725	674	623	572	526	451	398	360	333	313	297
			P_{cy}	842	842	783	711	632	551	475	349	262	202	160	129	107
	* 10.0	44.1	P_{cx}	1170	1170	1170	1170	1170	1170	1170	1170	1120	1060	1000	935	867
			P_{czz}	1130	1060	993	924	858	796	743	659	601	560	529	504	483
			P_{cy}	1170	1160	1060	951	832	713	606	438	326	250	197	159	131
	12.0	52.2	P_{cx}	1390	1390	1390	1390	1390	1390	1390	1390	1320	1250	1180	1100	1020
			P_{czz}	1330	1260	1180	1110	1050	994	946	871	818	778	745	716	688
			P_{cy}	1390	1370	1250	1120	978	838	711	513	381	292	230	186	153
	15.0	63.7	P_{cx}	1690	1690	1690	1690	1690	1690	1690	1690	1610	1520	1430	1330	1230
			P_{czz}	1620	1540	1470	1400	1350	1300	1270	1210	1160	1120	1080	1040	995
			P_{cy}	1690	1670	1530	1360	1190	1010	857	617	458	351	276	223	184
400 x 150	* 8.0	42.1	P_{cx}	888	888	888	888	888	888	888	888	877	845	811	776	
			P_{czz}	878	842	804	763	719	673	627	539	468	413	373	342	318
			P_{cy}	888	888	887	833	775	712	646	516	406	322	259	212	176
	* 10.0	52.0	P_{cx}	1280	1280	1280	1280	1280	1280	1280	1280	1280	1240	1190	1130	1070
			P_{czz}	1260	1200	1140	1080	1010	946	881	768	681	617	569	533	505
			P_{cy}	1280	1280	1260	1170	1070	971	866	672	519	407	325	265	219
	* 12.0	61.6	P_{cx}	1640	1640	1640	1640	1640	1640	1640	1640	1630	1560	1490	1410	1330
			P_{czz}	1600	1520	1450	1370	1290	1210	1140	1020	925	858	807	767	734
			P_{cy}	1640	1640	1580	1460	1340	1200	1060	810	620	483	385	313	259
	15.0	75.6	P_{cx}	2010	2010	2010	2010	2010	2010	2010	2010	1990	1910	1820	1720	1620
			P_{czz}	1960	1870	1780	1700	1620	1550	1480	1380	1300	1240	1190	1150	1110
			P_{cy}	2010	2010	1940	1790	1630	1460	1290	982	751	585	466	379	313

See Section 8.4.2 for guidance on calculating an effective length which allows for both the effects of end fixity and nominal end moments due to eccentricity of connection.

Slender sections must also be checked for the combined effects of the axial load and moment caused by the shift of neutral axis, see Section 8.4.2.

* Section is slender under axial compression and allowance has been made in calculating the compression resistance.

For explanation of table see Section 8.4

Table 29

COMPRESSION

DOUBLE CHANNELS BACK TO BACK
SUBJECT TO AXIAL COMPRESSION

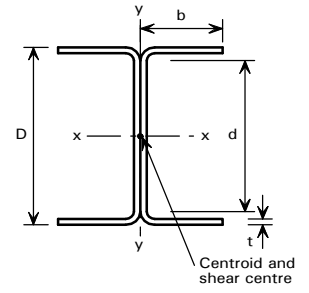

COMPRESSION RESISTANCE FOR GRADE 1.4301 (304)

D x 2b mm	t mm	Mass per Metre kg	Axis	Compression Resistance, P_{cx} , P_{cy} , P_{cz} (kN)												
				for Effective Length L_E (m)												
				1.0	1.5	2.0	2.5	3.0	3.5	4.0	5.0	6.0	7.0	8.0	9.0	10.0
50 x 50	* 2.0	2.90	P_{cx}	57.2	44.0	33.1	25.0	19.2	15.1	12.2	8.33	6.04	4.57	3.58	2.88	2.37
			P_{cy}	37.0	22.3	14.4	9.91	7.22	5.49	4.31	2.86	2.03	1.52	1.18	0.940	0.767
			P_{cz}	58.4	52.9	50.2	48.6	47.7	47.2	46.8	46.3	46.1	45.9	45.8	45.8	45.7
	3.0	4.15	P_{cx}	82.1	62.3	46.2	34.6	26.4	20.7	16.6	11.3	8.21	6.21	4.86	3.91	3.21
			P_{cy}	55.1	33.4	21.6	14.9	10.9	8.28	6.50	4.31	3.07	2.29	1.78	1.42	1.16
			P_{cz}	94.2	91.7	90.7	90.2	89.9	89.7	89.6	89.4	89.3	89.3	89.3	89.3	89.2
75 x 70	* 3.0	6.28	P_{cx}	146	125	105	87.0	71.5	59.0	49.1	35.0	26.0	20.0	15.9	12.9	10.7
			P_{cy}	107	73.8	51.0	36.6	27.2	21.0	16.7	11.2	8.02	6.03	4.70	3.76	3.08
			P_{cz}	140	127	119	114	111	108	107	105	104	104	103	103	103
	4.0	8.12	P_{cx}	188	160	134	110	90.3	74.3	61.6	43.8	32.5	25.0	19.8	16.0	13.3
			P_{cy}	140	97.6	67.8	48.7	36.3	28.0	22.3	15.0	10.7	8.07	6.29	5.04	4.13
			P_{cz}	187	178	174	171	170	169	168	167	167	167	167	166	166
	5.0	9.82	P_{cx}	226	192	159	130	106	87.2	72.2	51.2	37.9	29.1	23.0	18.7	15.4
			P_{cy}	172	120	84.3	60.8	45.4	35.1	27.9	18.8	13.5	10.1	7.91	6.34	5.19
			P_{cz}	234	228	226	224	224	223	223	222	222	222	222	222	222
100 x 100	* 3.0	8.89	P_{cx}	203	184	165	147	129	113	99.4	76.0	59.0	46.7	37.7	31.0	25.9
			P_{cy}	170	137	107	83.5	65.6	52.3	42.5	29.4	21.5	16.3	12.8	10.3	8.51
			P_{cz}	192	174	158	144	133	124	118	110	105	102	100	99.0	98.0
	* 4.0	11.6	P_{cx}	286	256	228	201	176	152	132	100	76.9	60.5	48.7	39.9	33.3
			P_{cy}	239	190	147	114	89.2	70.9	57.4	39.6	28.9	22.0	17.2	13.9	11.4
			P_{cz}	271	250	233	220	211	205	200	194	190	188	187	186	185
	5.0	14.2	P_{cx}	355	318	282	247	215	186	160	120	92.4	72.6	58.3	47.7	39.8
			P_{cy}	299	238	185	143	111	88.9	72.0	49.7	36.2	27.5	21.6	17.4	14.3
			P_{cz}	341	321	307	298	292	288	285	281	279	278	277	276	276
125 x 100	* 3.0	10.1	P_{cx}	233	215	198	181	165	149	134	108	87.2	70.8	58.2	48.5	40.9
			P_{cy}	184	145	112	86.6	67.4	53.5	43.3	29.8	21.7	16.5	12.9	10.4	8.58
			P_{cz}	212	192	172	153	138	127	118	107	100	96.3	93.4	91.4	89.9
	* 4.0	13.2	P_{cx}	338	310	283	257	232	208	185	146	116	93.9	76.6	63.5	53.4
			P_{cy}	265	206	157	119	92.5	73.1	58.9	40.4	29.4	22.3	17.5	14.1	11.6
			P_{cz}	309	281	257	237	223	212	205	194	188	184	182	180	179
	5.0	16.1	P_{cx}	421	386	351	318	286	255	227	178	141	113	92.4	76.5	64.3
			P_{cy}	332	259	197	150	116	91.7	74.0	50.8	36.9	28.0	21.9	17.6	14.5
			P_{cz}	387	359	338	322	312	304	299	292	287	285	283	282	281
	6.0	19.0	P_{cx}	494	452	411	372	333	297	263	206	163	130	106	88.0	73.9
			P_{cy}	392	307	235	179	139	110	88.8	61.0	44.4	33.7	26.4	21.2	17.5
			P_{cz}	458	433	416	405	398	393	390	385	383	381	380	379	379
150 x 120	* 4.0	16.0	P_{cx}	397	378	353	328	303	279	256	213	176	146	122	103	87.7
			P_{cy}	333	275	222	177	141	114	93.7	65.6	48.2	36.8	29.0	23.5	19.3
			P_{cz}	370	342	313	286	262	243	228	207	194	185	179	175	172
	* 5.0	19.7	P_{cx}	518	489	454	420	388	355	324	268	220	181	150	126	107
			P_{cy}	431	354	284	226	180	145	118	82.8	60.8	46.4	36.5	29.5	24.3
			P_{cz}	480	446	413	386	364	346	333	315	304	296	291	288	285
	6.0	23.2	P_{cx}	617	581	539	498	458	420	382	314	257	211	175	147	124
			P_{cy}	515	424	341	271	216	174	142	99.6	73.1	55.8	44.0	35.5	29.3
			P_{cz}	573	536	506	482	464	451	441	428	420	415	411	409	407
	8.0	29.9	P_{cx}	795	745	690	636	584	533	484	396	322	264	218	183	155
			P_{cy}	668	553	448	358	286	231	189	133	97.8	74.8	59.0	47.6	39.3
			P_{cz}	742	708	686	671	661	654	650	644	640	638	637	636	635

* Section is slender under axial compression and allowance has been made in calculating the compression resistance.

For explanation of table see Section 8.4.

Table 29

COMPRESSION

DOUBLE CHANNELS BACK TO BACK
SUBJECT TO AXIAL COMPRESSION

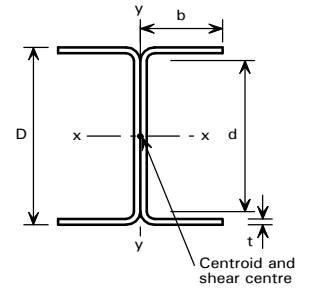

COMPRESSION RESISTANCE FOR GRADE 1.4301 (304)

D x 2b mm	t mm	Mass per Metre kg	Axis	Compression Resistance, P_{cx} , P_{cy} , P_{cz} (kN)												
				for Effective Length L_E (m)												
				1.0	1.5	2.0	2.5	3.0	3.5	4.0	5.0	6.0	7.0	8.0	9.0	10.0
175 x 120	* 5.0	21.7	P_{cx}	570	554	520	487	455	423	392	334	282	237	200	170	146
			P_{cy}	466	378	299	235	185	148	121	84.2	61.6	46.9	36.9	29.8	24.5
			P_{cz}	528	488	448	412	382	358	340	315	300	290	283	278	275
	6.0	25.6	P_{cx}	680	659	618	578	539	501	464	394	331	278	234	199	170
			P_{cy}	557	453	359	282	223	178	145	101	74.2	56.5	44.5	35.9	29.6
			P_{cz}	630	586	547	515	489	470	455	436	423	416	410	407	404
	8.0	33.1	P_{cx}	879	848	794	742	691	641	592	500	419	351	295	250	213
			P_{cy}	726	594	474	374	297	238	194	135	99.5	75.9	59.7	48.2	39.7
			P_{cz}	818	774	743	721	706	695	687	677	672	668	665	664	662
	10.0	40.1	P_{cx}	1060	1020	956	892	828	767	707	594	496	413	347	293	250
			P_{cy}	887	730	586	465	371	299	244	170	125	95.8	75.4	60.9	50.2
			P_{cz}	996	959	937	923	915	909	905	900	897	896	894	894	893
200 x 150	* 5.0	26.0	P_{cx}	631	631	602	571	541	512	483	426	373	325	282	245	213
			P_{cy}	566	490	417	350	292	243	204	147	109	85.0	67.5	54.9	45.4
			P_{cz}	606	572	535	498	462	429	401	356	326	306	292	281	274
	* 6.0	30.8	P_{cx}	802	800	758	718	678	639	601	527	458	395	341	294	255
			P_{cy}	714	615	520	434	360	298	249	179	133	103	81.8	66.4	55.0
			P_{cz}	767	723	678	635	596	561	533	490	462	443	430	420	413
	8.0	40.0	P_{cx}	1060	1060	999	944	891	838	786	686	593	510	438	377	326
			P_{cy}	948	818	693	579	480	399	333	239	178	138	109	89.0	73.7
			P_{cz}	1020	962	915	875	843	817	797	769	751	739	731	725	721
	10.0	48.7	P_{cx}	1300	1280	1210	1140	1080	1010	948	825	711	609	522	449	388
			P_{cy}	1160	1000	854	716	597	497	416	300	224	173	137	111	92.6
			P_{cz}	1240	1180	1140	1110	1090	1070	1060	1040	1030	1020	1020	1020	1020
225 x 150	* 6.0	33.2	P_{cx}	865	865	835	795	757	718	681	607	537	472	413	362	317
			P_{cy}	762	651	547	452	372	307	255	182	135	104	82.6	67.0	55.4
			P_{cz}	827	777	726	676	628	586	551	498	462	439	422	410	401
	8.0	43.2	P_{cx}	1150	1150	1100	1050	996	944	893	794	699	612	534	466	407
			P_{cy}	1010	867	728	603	497	410	341	244	181	139	110	89.9	74.4
			P_{cz}	1100	1030	978	929	888	855	828	789	765	748	737	729	723
	10.0	52.7	P_{cx}	1400	1400	1340	1270	1210	1150	1080	959	842	735	640	557	487
			P_{cy}	1240	1070	900	748	618	512	427	305	227	175	139	113	93.6
			P_{cz}	1340	1270	1220	1180	1150	1130	1110	1090	1070	1060	1060	1050	1050
	12.0	61.7	P_{cx}	1640	1640	1560	1480	1410	1330	1260	1110	972	846	735	638	557
			P_{cy}	1460	1260	1070	891	739	614	513	368	274	212	168	136	113
			P_{cz}	1570	1500	1460	1430	1410	1390	1380	1370	1360	1350	1350	1350	1350
250 x 200	* 6.0	40.3	P_{cx}	933	933	932	896	861	826	792	725	660	598	538	483	433
			P_{cy}	902	818	737	658	583	513	450	346	269	214	173	142	119
			P_{cz}	924	887	849	810	769	728	688	614	555	509	475	449	429
	* 8.0	52.7	P_{cx}	1370	1370	1350	1300	1240	1190	1140	1030	929	833	743	661	587
			P_{cy}	1310	1180	1060	940	826	722	629	478	370	292	235	193	161
			P_{cz}	1350	1290	1240	1180	1130	1080	1030	951	893	851	820	796	779
	10.0	64.5	P_{cx}	1720	1720	1690	1620	1540	1480	1410	1270	1150	1020	909	806	715
			P_{cy}	1640	1480	1330	1180	1040	905	788	600	464	366	295	243	203
			P_{cz}	1680	1610	1550	1490	1440	1390	1350	1290	1250	1220	1200	1180	1170
	12.0	75.9	P_{cx}	2020	2020	1980	1890	1810	1730	1650	1490	1340	1190	1060	934	827
			P_{cy}	1940	1750	1570	1400	1230	1080	940	718	556	440	355	292	244
			P_{cz}	1980	1900	1830	1780	1730	1700	1670	1620	1590	1570	1560	1550	1540

* Section is slender under axial compression and allowance has been made in calculating the compression resistance.

For explanation of table see Section 8.4.

Table 29

COMPRESSION

**DOUBLE CHANNELS BACK TO BACK
SUBJECT TO AXIAL COMPRESSION**

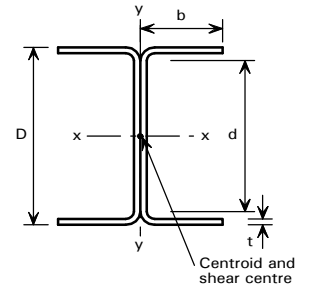

COMPRESSION RESISTANCE FOR GRADE 1.4301 (304)

D x 2b mm	t mm	Mass per Metre kg	Axis	Compression Resistance, P_{cx} , P_{cy} , P_{cz} (kN)												
				for Effective Length L_E (m)												
				1.0	1.5	2.0	2.5	3.0	3.5	4.0	5.0	6.0	7.0	8.0	9.0	10.0
300 x 200	* 8.0	59.0	P_{cx}	1540	1540	1540	1500	1450	1400	1350	1240	1150	1050	956	868	786
			P_{cy}	1460	1310	1160	1020	885	766	661	497	381	299	240	197	164
			P_{cz}	1510	1450	1380	1320	1250	1180	1120	1010	928	867	823	789	764
	10.0	72.4	P_{cx}	1930	1930	1930	1870	1810	1740	1670	1540	1420	1290	1180	1070	963
			P_{cy}	1820	1630	1450	1280	1110	960	830	624	478	376	302	247	206
			P_{cz}	1890	1810	1730	1660	1590	1520	1470	1370	1310	1260	1220	1200	1180
	12.0	85.4	P_{cx}	2270	2270	2270	2200	2120	2040	1960	1810	1660	1510	1370	1240	1120
			P_{cy}	2150	1930	1720	1520	1320	1150	992	748	575	452	363	298	248
			P_{cz}	2220	2130	2050	1980	1910	1860	1810	1740	1690	1660	1630	1620	1600
	15.0	103	P_{cx}	2760	2760	2760	2670	2570	2470	2370	2180	2000	1820	1650	1480	1340
			P_{cy}	2630	2370	2110	1870	1630	1420	1230	934	720	567	457	375	313
			P_{cz}	2700	2600	2520	2450	2400	2360	2330	2290	2260	2240	2230	2220	2210
350 x 250	* 8.0	71.6	P_{cx}	1660	1660	1660	1660	1630	1590	1540	1450	1370	1280	1200	1120	1040
			P_{cy}	1660	1530	1410	1290	1180	1070	960	773	623	505	415	346	292
			P_{cz}	1660	1620	1560	1510	1450	1400	1340	1220	1110	1020	941	881	833
	* 10.0	88.2	P_{cx}	2300	2300	2300	2300	2240	2170	2100	1970	1840	1720	1600	1480	1360
			P_{cy}	2280	2100	1920	1750	1580	1420	1270	1010	809	652	534	443	373
			P_{cz}	2300	2220	2150	2070	1990	1910	1840	1690	1570	1470	1390	1330	1290
	12.0	104	P_{cx}	2770	2770	2770	2770	2690	2610	2520	2360	2210	2050	1900	1750	1620
			P_{cy}	2750	2530	2320	2110	1910	1720	1540	1220	974	786	643	534	449
			P_{cz}	2770	2680	2590	2500	2410	2330	2250	2120	2010	1930	1860	1810	1780
	15.0	127	P_{cx}	3390	3390	3390	3380	3280	3170	3070	2870	2680	2490	2300	2120	1950
			P_{cy}	3370	3100	2840	2600	2350	2120	1900	1520	1220	982	804	668	563
			P_{cz}	3380	3270	3160	3070	2990	2910	2850	2740	2660	2610	2570	2540	2510
400 x 300	* 8.0	84.3	P_{cx}	1750	1750	1750	1750	1750	1740	1700	1620	1540	1470	1390	1320	1250
			P_{cy}	1750	1700	1600	1500	1400	1310	1210	1030	873	736	622	529	454
			P_{cz}	1750	1740	1700	1660	1610	1560	1510	1410	1310	1210	1110	1030	958
	* 10.0	104	P_{cx}	2530	2530	2530	2530	2530	2470	2410	2290	2170	2050	1930	1820	1710
			P_{cy}	2530	2420	2270	2110	1960	1810	1670	1400	1170	973	816	689	588
			P_{cz}	2530	2500	2430	2360	2290	2220	2140	1990	1850	1720	1600	1510	1430
	* 12.0	123	P_{cx}	3210	3210	3210	3210	3200	3120	3030	2870	2710	2560	2410	2260	2110
			P_{cy}	3210	3060	2860	2660	2460	2270	2080	1740	1440	1200	998	841	716
			P_{cz}	3210	3160	3070	2980	2890	2800	2710	2540	2380	2250	2130	2040	1960
	15.0	151	P_{cx}	4020	4020	4020	4020	3990	3880	3780	3570	3370	3170	2980	2780	2600
			P_{cy}	4020	3840	3580	3330	3080	2840	2610	2180	1810	1500	1250	1060	899
			P_{cz}	4020	3940	3830	3730	3630	3530	3430	3270	3130	3020	2930	2860	2800

* Section is slender under axial compression and allowance has been made in calculating the compression resistance.

For explanation of table see Section 8.4.

Table 30

COMPRESSION

**EQUAL ANGLES
SUBJECT TO AXIAL COMPRESSION**

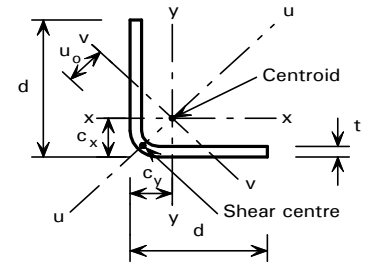

COMPRESSION RESISTANCE FOR GRADE 1.4301 (304)

d x d mm	t mm	Mass per Metre kg	Axis	Compression Resistance, P_{cx} , P_{cy} , P_{ouz} , P_{cv} (kN)															
				for Effective Length L_E (m)															
				1.0	1.5	2.0	2.5	3.0	3.5	4.0	5.0	6.0	7.0	8.0	9.0	10.0			
50 x 50	* 5.0	3.54	P_{cx}, P_{cy}	76.1	54.2	36.8	25.7	18.8	14.3	11.2	7.40	5.25	3.92	3.03	2.42	1.97			
			P_{ouz}	74.8	64.1	50.7	38.6	29.4	22.9	18.2	12.2	8.70	6.52	5.06	4.04	3.29			
			P_{cv}	45.2	24.1	14.5	9.65	6.87	5.14	3.99	2.60	1.83	1.35	1.04	0.830	0.675			
	6.0	4.15	P_{cx}, P_{cy}	90.9	63.8	42.9	29.8	21.8	16.5	12.9	8.54	6.06	4.52	3.50	2.79	2.27			
			P_{ouz}	92.7	78.5	61.2	46.0	34.8	26.9	21.4	14.3	10.2	7.60	5.89	4.70	3.84			
			P_{cv}	51.0	26.7	16.0	10.6	7.56	5.65	4.38	2.85	2.00	1.49	1.14	0.909	0.740			
	8.0	5.27	P_{cx}, P_{cy}	114	79.1	52.8	36.6	26.7	20.2	15.8	10.4	7.41	5.52	4.27	3.41	2.78			
			P_{ouz}	120	101	78.2	58.4	44.0	33.9	26.8	17.9	12.7	9.49	7.36	5.87	4.79			
			P_{cv}	57.9	29.7	17.7	11.7	8.30	6.19	4.80	3.12	2.19	1.62	1.25	0.993	0.807			
	10.0	6.26	P_{cx}, P_{cy}	133	91.5	60.6	41.9	30.5	23.1	18.1	11.9	8.44	6.29	4.87	3.88	3.16			
			P_{ouz}	143	120	92.4	68.6	51.5	39.6	31.3	20.8	14.8	11.0	8.55	6.81	5.56			
			P_{cv}	60.2	30.3	17.9	11.8	8.38	6.24	4.83	3.14	2.20	1.63	1.26	0.996	0.810			
75 x 75	* 6.0	6.52	P_{cx}, P_{cy}	143	125	104	83.8	66.0	52.3	42.1	28.7	20.7	15.6	12.2	9.76	7.99			
			P_{ouz}	119	115	107	96.9	84.5	72.2	61.2	44.1	32.7	25.1	19.7	15.9	13.1			
			P_{cv}	117	82.2	55.0	38.2	27.9	21.1	16.6	10.9	7.75	5.78	4.47	3.56	2.91			
	8.0	8.43	P_{cx}, P_{cy}	218	185	148	114	88.0	68.8	54.9	37.0	26.6	20.0	15.6	12.5	10.2			
			P_{ouz}	196	185	167	146	123	102	84.7	59.4	43.4	33.0	25.8	20.7	17.0			
			P_{cv}	167	107	68.9	47.1	34.0	25.6	20.0	13.2	9.30	6.92	5.35	4.26	3.47			
	10.0	10.2	P_{cx}, P_{cy}	263	222	177	136	104	81.5	65.0	43.8	31.4	23.6	18.4	14.7	12.0			
			P_{ouz}	246	230	207	180	151	124	103	71.9	52.4	39.7	31.0	24.9	20.4			
			P_{cv}	194	121	77.0	52.3	37.7	28.4	22.2	14.6	10.3	7.65	5.91	4.70	3.83			
	12.0	11.9	P_{cx}, P_{cy}	304	256	203	155	118	92.6	73.8	49.7	35.6	26.8	20.8	16.7	13.6			
			P_{ouz}	291	270	243	210	176	144	119	83.0	60.3	45.6	35.7	28.6	23.4			
			P_{cv}	215	130	81.8	55.4	39.8	29.9	23.3	15.3	10.8	8.02	6.20	4.93	4.02			
100 x 100	* 8.0	11.6	P_{cx}, P_{cy}	255	247	223	195	167	140	117	83.3	61.3	46.8	36.8	29.7	24.4			
			P_{ouz}	215	211	205	195	182	166	150	118	92.1	72.6	58.2	47.5	39.4			
			P_{cv}	238	193	146	107	81.1	62.6	49.5	33.1	23.7	17.7	13.8	11.0	9.00			
	* 10.0	14.2	P_{cx}, P_{cy}	363	343	304	260	216	178	147	102	75.2	57.1	44.8	36.0	29.6			
			P_{ouz}	319	312	299	280	256	229	202	154	117	91.5	72.7	59.0	48.8			
			P_{cv}	325	251	180	129	96.2	73.7	58.1	38.6	27.5	20.6	15.9	12.7	10.4			
	12.0	16.6	P_{cx}, P_{cy}	441	413	363	308	255	208	171	119	87.0	66.0	51.7	41.6	34.2			
			P_{ouz}	401	390	370	345	313	279	244	183	139	107	85.4	69.2	57.1			
			P_{cv}	386	290	204	145	106	81.5	64.1	42.5	30.2	22.6	17.5	14.0	11.4			
	15.0	20.0	P_{cx}, P_{cy}	532	495	434	367	302	246	202	140	102	77.5	60.7	48.8	40.1			
			P_{ouz}	500	482	455	422	383	340	296	222	167	129	102	82.6	68.1			
			P_{cv}	453	329	226	159	116	88.8	69.7	46.1	32.7	24.4	18.9	15.1	12.3			
120 x 120	* 8.0	14.1	P_{cx}, P_{cy}	273	273	262	242	219	196	172	130	99.8	77.6	61.8	50.2	41.5			
			P_{ouz}	221	218	215	210	203	195	184	159	133	110	91.7	76.5	64.5			
			P_{cv}	273	241	203	164	130	103	83.9	57.3	41.4	31.2	24.4	19.5	16.0			
	* 10.0	17.3	P_{cx}, P_{cy}	393	393	367	333	297	260	224	166	124	96.3	76.3	61.8	51.0			
			P_{ouz}	336	331	324	314	301	284	264	220	179	144	118	97.5	81.5			
			P_{cv}	385	330	267	208	161	126	101	68.4	49.2	37.0	28.8	23.1	18.9			
	* 12.0	20.4	P_{cx}, P_{cy}	523	520	476	427	375	322	274	199	148	113	89.8	72.6	59.8			
			P_{ouz}	463	455	444	426	403	375	344	279	222	176	142	117	97.4			
			P_{cv}	500	417	325	246	187	145	115	77.7	55.6	41.7	32.5	26.0	21.2			
	15.0	24.8	P_{cx}, P_{cy}	658	649	592	527	459	392	331	239	177	135	107	86.4	71.2			
			P_{ouz}	607	595	576	549	516	477	435	348	274	217	174	142	118			
			P_{cv}	616	502	381	283	213	164	130	87.3	62.4	46.7	36.3	29.0	23.7			

See Section 8.4.2 for guidance on calculating an effective length which allows for both the effects of end fixity and nominal end moments due to eccentricity of connection.

Slender sections must also be checked for the combined effects of the axial load and moment caused by the shift of neutral axis, see Section 8.4.2

* Section is slender under axial compression and allowance has been made in calculating the compression resistance.

For explanation of table see Section 8.4

Table 30

COMPRESSION

**EQUAL ANGLES
SUBJECT TO AXIAL COMPRESSION**

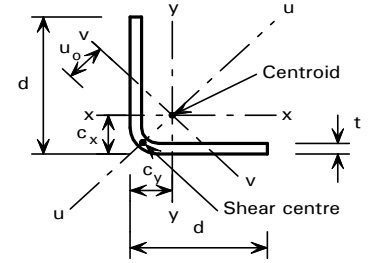

COMPRESSION RESISTANCE FOR GRADE 1.4301 (304)

d x d mm	t mm	Mass per Metre kg	Axis	Compression Resistance, P_{cx} , P_{cy} , P_{ouz} , P_{cv} (kN)												
				for Effective Length L_E (m)												
				1.0	1.5	2.0	2.5	3.0	3.5	4.0	5.0	6.0	7.0	8.0	9.0	10.0
150 x 150	* 8.0	17.9	P_{cx}, P_{cy}	293	293	293	288	273	257	239	202	166	135	111	92.2	77.3
			P_{ouz}	222	220	218	215	212	209	204	192	177	159	140	123	108
			P_{cv}	293	289	263	235	204	174	147	106	78.7	60.3	47.5	38.4	31.6
	* 10.0	22.1	P_{cx}, P_{cy}	427	427	427	410	384	357	328	269	216	173	140	115	96.5
			P_{ouz}	347	344	340	336	330	323	313	288	257	224	193	166	143
			P_{cv}	427	409	366	318	268	223	185	131	96.1	73.2	57.5	46.3	38.1
	* 12.0	26.1	P_{cx}, P_{cy}	575	575	574	540	502	461	419	335	264	209	168	137	114
			P_{ouz}	489	485	479	471	461	447	430	387	338	288	244	207	176
			P_{cv}	575	537	471	398	328	268	220	152	111	84.5	66.2	53.2	43.7
	* 15.0	31.9	P_{cx}, P_{cy}	818	818	800	745	684	619	552	428	331	259	207	169	140
			P_{ouz}	727	719	709	693	672	646	613	537	456	380	316	264	223
			P_{cv}	818	733	623	509	406	325	263	180	130	98.7	77.1	61.8	50.7
200 x 200	* 8.0	24.2	P_{cx}, P_{cy}	316	316	316	316	316	316	305	283	258	231	205	179	157
			P_{ouz}	214	210	208	207	206	204	203	199	194	188	180	171	161
			P_{cv}	316	316	316	304	285	266	244	201	161	130	105	86.8	72.5
	* 10.0	30.0	P_{cx}, P_{cy}	466	466	466	466	466	456	438	400	358	315	273	235	203
			P_{ouz}	349	344	341	339	337	334	331	322	311	297	280	260	240
			P_{cv}	466	466	464	434	403	369	333	264	207	163	131	107	89.5
	* 12.0	35.6	P_{cx}, P_{cy}	636	636	636	636	635	610	583	525	462	399	340	290	248
			P_{ouz}	507	501	497	494	490	485	479	464	443	416	385	352	319
			P_{cv}	636	636	619	575	526	474	421	324	249	195	155	126	105
	* 15.0	43.7	P_{cx}, P_{cy}	921	921	921	921	899	858	814	718	617	521	438	368	312
			P_{ouz}	778	771	765	759	752	742	731	699	656	604	547	489	435
			P_{cv}	921	921	868	794	712	627	545	406	306	237	188	152	126

See Section 8.4.2 for guidance on calculating an effective length which allows for both the effects of end fixity and nominal end moments due to eccentricity of connection.

Slender sections must also be checked for the combined effects of the axial load and moment caused by the shift of neutral axis, see Section 8.4.2

* Section is slender under axial compression and allowance has been made in calculating the compression resistance.

For explanation of table see Section 8.4

Table 31

COMPRESSION

**DOUBLE ANGLES BACK TO BACK
SUBJECT TO AXIAL COMPRESSION**

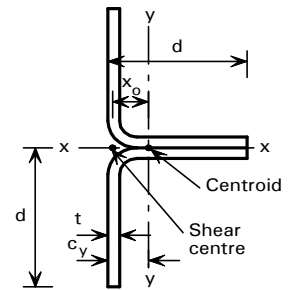

COMPRESSION RESISTANCE FOR GRADE 1.4301 (304)

2d x d mm	t mm	Mass per Metre kg	Axis	Compression Resistance, P_{cx} , P_{cxz} , P_{cy} (kN)												
				for Effective Length L_E (m)												
				1.0	1.5	2.0	2.5	3.0	3.5	4.0	5.0	6.0	7.0	8.0	9.0	10.0
100 x 50	* 5.0	7.08	P_{cx}	145	116	91.1	70.7	55.4	44.1	35.8	24.7	18.0	13.7	10.8	8.69	7.15
			P_{cxz}	153	137	112	87.8	67.9	53.1	42.4	28.5	20.4	15.3	11.9	9.47	7.73
			P_{cy}	122	86.5	60.8	44.0	33.0	25.5	20.3	13.7	9.84	7.41	5.78	4.63	3.79
	6.0	8.30	P_{cx}	176	141	110	85.4	66.9	53.3	43.2	29.8	21.8	16.6	13.0	10.5	8.63
			P_{cxz}	191	168	137	107	82.5	64.4	51.3	34.5	24.6	18.4	14.3	11.4	9.33
			P_{cy}	145	101	71.2	51.3	38.3	29.6	23.5	15.8	11.4	8.55	6.67	5.34	4.38
	8.0	10.5	P_{cx}	227	183	144	112	88.6	70.8	57.6	39.9	29.2	22.2	17.4	14.1	11.6
			P_{cxz}	250	220	181	142	110	86.4	68.9	46.4	33.1	24.8	19.3	15.4	12.6
			P_{cy}	182	126	87.9	63.1	47.1	36.4	28.9	19.4	13.9	10.5	8.16	6.53	5.35
	10.0	12.5	P_{cx}	273	222	176	139	110	88.4	72.0	50.1	36.7	28.0	22.0	17.8	14.6
			P_{cxz}	301	267	223	177	138	108	86.9	58.5	41.9	31.4	24.4	19.5	15.9
			P_{cy}	213	146	101	72.5	54.0	41.6	33.0	22.2	15.9	11.9	9.30	7.45	6.10
150 x 75	* 6.0	13.0	P_{cx}	267	236	207	179	153	130	111	82.4	62.5	48.8	39.0	31.9	26.5
			P_{cxz}	239	234	224	207	184	160	136	99.7	74.2	56.9	44.8	36.1	29.7
			P_{cy}	244	203	166	133	107	87.4	71.9	50.5	37.2	28.5	22.5	18.2	15.0
	8.0	16.9	P_{cx}	408	357	308	262	221	186	157	114	86.4	67.1	53.4	43.5	36.1
			P_{cxz}	393	381	355	318	275	233	195	139	102	77.8	61.0	49.1	40.3
			P_{cy}	366	297	235	184	145	116	95.1	66.1	48.3	36.8	29.0	23.4	19.2
	10.0	20.4	P_{cx}	497	436	378	323	273	231	195	143	107	83.9	66.9	54.5	45.2
			P_{cxz}	497	477	441	395	343	291	245	174	128	97.9	76.8	61.7	50.7
			P_{cy}	441	357	281	220	173	138	112	78.3	57.2	43.6	34.3	27.6	22.8
	12.0	23.7	P_{cx}	580	511	444	381	324	275	233	171	129	100	80.4	65.6	54.5
			P_{cxz}	591	563	520	468	409	349	294	210	155	118	92.7	74.6	61.2
			P_{cy}	510	410	322	251	197	157	128	88.9	64.9	49.4	38.8	31.3	25.8
200 x 100	* 8.0	23.2	P_{cx}	503	461	420	381	342	306	272	214	169	136	111	92.0	77.3
			P_{cxz}	427	423	417	405	385	359	328	263	207	164	131	107	89.4
			P_{cy}	471	416	362	311	265	225	191	140	106	82.9	66.2	54.0	44.8
	* 10.0	28.3	P_{cx}	708	644	583	524	467	413	364	282	221	176	143	118	98.9
			P_{cxz}	635	628	614	587	548	501	450	351	271	212	169	137	113
			P_{cy}	656	571	489	413	345	289	243	176	132	102	81.3	66.1	54.8
	12.0	33.2	P_{cx}	858	781	706	634	565	500	440	341	267	213	172	142	119
			P_{cxz}	800	790	766	726	675	615	551	428	329	257	205	166	137
			P_{cy}	791	684	583	489	407	339	284	205	153	118	94.1	76.5	63.3
	15.0	40.0	P_{cx}	1040	947	860	774	692	614	543	423	332	265	215	178	149
			P_{cxz}	1000	983	945	894	831	760	684	535	413	323	258	209	173
			P_{cy}	949	819	695	582	483	401	336	241	180	139	110	89.8	74.4
240 x 120	* 8.0	28.2	P_{cx}	546	521	486	452	418	386	354	295	245	203	169	143	121
			P_{cxz}	438	434	431	426	419	407	391	347	295	246	204	170	143
			P_{cy}	532	484	438	394	351	311	274	212	166	132	107	88.9	74.5
	* 10.0	34.6	P_{cx}	786	739	685	633	582	532	484	397	325	267	221	185	157
			P_{cxz}	665	660	654	644	626	600	566	484	400	327	267	221	185
			P_{cy}	752	678	607	538	473	413	359	273	211	166	134	110	92.3
	* 12.0	40.8	P_{cx}	1050	973	898	825	754	686	620	503	407	331	273	228	192
			P_{cxz}	918	911	900	879	846	800	746	623	505	407	331	272	227
			P_{cy}	988	883	782	685	594	513	442	331	253	198	159	130	108
	15.0	49.5	P_{cx}	1320	1220	1130	1040	948	862	779	632	511	417	343	287	242
			P_{cxz}	1210	1200	1180	1140	1090	1020	952	794	642	516	419	344	286
			P_{cy}	1230	1100	968	843	728	625	536	399	304	238	191	156	130

See Section 8.4.2 for guidance on calculating an effective length which allows for both the effects of end fixity and nominal end moments due to eccentricity of connection.

Slender sections must also be checked for the combined effects of the axial load and moment caused by the shift of neutral axis, see Section 8.4.2.

* Section is slender under axial compression and allowance has been made in calculating the compression resistance.

Table 31

COMPRESSION

**DOUBLE ANGLES BACK TO BACK
SUBJECT TO AXIAL COMPRESSION**

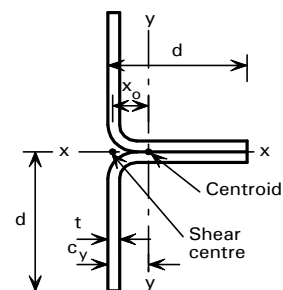

COMPRESSION RESISTANCE FOR GRADE 1.4301 (304)

2d x d mm	t mm	Mass per Metre kg	Axis	Compression Resistance, P_{cx} , P_{czz} , P_{cy} (kN)												
				for Effective Length L_E (m)												
				1.0	1.5	2.0	2.5	3.0	3.5	4.0	5.0	6.0	7.0	8.0	9.0	10.0
300 x 150	* 8.0	35.8	P_{cx}	586	586	561	532	505	478	451	400	351	306	266	231	202
			P_{czz}	439	435	433	430	427	424	419	404	380	347	310	273	239
			P_{cy}	586	561	523	487	452	417	383	320	266	221	185	156	133
	* 10.0	44.1	P_{cx}	854	849	803	760	717	675	633	554	479	412	355	306	265
			P_{czz}	687	682	678	674	668	660	648	612	558	494	429	370	319
			P_{cy}	854	801	742	685	629	575	523	428	349	286	237	198	168
	* 12.0	52.2	P_{cx}	1150	1130	1070	1010	946	886	828	716	613	522	446	382	329
			P_{czz}	968	962	957	949	939	923	899	830	738	640	547	466	398
			P_{cy}	1150	1060	977	895	815	738	665	535	430	349	287	239	202
	* 15.0	63.7	P_{cx}	1640	1590	1500	1400	1310	1220	1140	969	820	692	585	498	427
			P_{czz}	1440	1430	1420	1410	1380	1350	1300	1170	1010	861	725	610	517
			P_{cy}	1610	1480	1350	1220	1100	984	876	691	547	439	358	297	249
400 x 200	* 8.0	48.5	P_{cx}	632	632	632	624	603	582	562	522	484	446	409	374	341
			P_{czz}	423	415	412	410	409	407	405	401	396	389	379	367	350
			P_{cy}	632	632	618	591	564	538	512	462	413	368	325	287	254
	* 10.0	59.9	P_{cx}	933	933	933	908	874	842	810	747	685	626	569	515	465
			P_{czz}	689	680	676	673	670	667	664	655	643	624	599	565	526
			P_{cy}	933	933	897	853	811	769	728	647	570	500	436	381	333
	* 12.0	71.1	P_{cx}	1270	1270	1270	1220	1180	1130	1080	991	903	817	737	661	593
			P_{czz}	1000	990	985	981	977	972	966	950	924	885	833	770	703
			P_{cy}	1270	1270	1210	1140	1080	1020	959	842	733	634	547	474	411
	* 15.0	87.4	P_{cx}	1840	1840	1820	1740	1670	1600	1530	1390	1250	1120	1000	890	791
			P_{czz}	1540	1530	1520	1510	1510	1500	1480	1450	1380	1300	1190	1080	966
			P_{cy}	1840	1810	1710	1610	1510	1420	1320	1140	979	835	712	610	525

See Section 8.4.2 for guidance on calculating an effective length which allows for both the effects of end fixity and nominal end moments due to eccentricity of connection.

Slender sections must also be checked for the combined effects of the axial load and moment caused by the shift of neutral axis, see Section 8.4.2.

* Section is slender under axial compression and allowance has been made in calculating the compression resistance.

Table 32

TENSION

**EQUAL ANGLES
SUBJECT TO AXIAL TENSION**

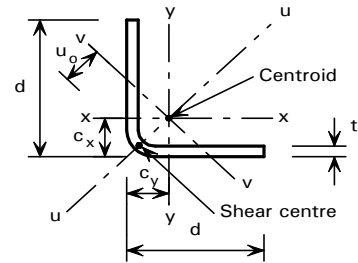

TENSION CAPACITY FOR GRADE 1.4301 (304)

d x d mm	t mm	Mass per Metre kg	Radius of Gyration v-v axis cm	Gross Area cm ²	Weld or Bolt Size	Holes Deducted From Angle		Equivalent Tension Area cm ²	Tension Capacity kN
						No.	Diameter mm		
50 x 50	5.0	3.54	0.892	4.48	Weld	0	-	3.89	81.6
					M12	1	13	3.21	67.4
50 x 50	6.0	4.15	0.861	5.25	Weld	0	-	4.58	96.1
					M12	1	13	3.79	79.6
50 x 50	8.0	5.27	0.797	6.67	Weld	0	-	5.87	123
					M12	1	13	4.89	102
50 x 50	10.0	6.26	0.732	7.93	Weld	0	-	7.05	148
					M12	1	13	5.90	123
75 x 75	6.0	6.52	1.38	8.25	Weld	0	-	7.13	149
					M16	1	18	5.98	125
					M20	1	22	5.69	119
75 x 75	8.0	8.43	1.32	10.7	Weld	0	-	9.27	194
					M16	1	18	7.81	163
					M20	1	22	7.42	155
75 x 75	10.0	10.2	1.26	12.9	Weld	0	-	11.3	237
					M16	1	18	9.55	200
					M20	1	22	9.07	190
75 x 75	12.0	11.9	1.20	15.0	Weld	0	-	13.2	277
					M16	1	18	11.2	235
					M20	1	22	10.6	223
100 x 100	8.0	11.6	1.84	14.7	Weld	0	-	12.7	266
					M20	1	22	10.8	227
					M24	1	26	10.4	219
100 x 100	10.0	14.2	1.78	17.9	Weld	0	-	15.5	326
					M20	1	22	13.3	279
					M24	1	26	12.8	269
100 x 100	12.0	16.6	1.72	21.0	Weld	0	-	18.3	384
					M20	1	22	15.7	330
					M24	1	26	15.2	318
100 x 100	15.0	20.0	1.63	25.3	Weld	0	-	22.2	466
					M20	1	22	19.2	403
					M24	1	26	18.5	388
120 x 120	8.0	14.1	2.25	17.9	Weld	0	-	15.4	323
					M20	1	22	13.5	284
					M24	1	26	13.2	276
120 x 120	10.0	17.3	2.20	21.9	Weld	0	-	18.9	397
					M20	1	22	16.7	351
					M24	1	26	16.2	341
120 x 120	12.0	20.4	2.14	25.8	Weld	0	-	22.4	470
					M20	1	22	19.8	416
					M24	1	26	19.2	404
120 x 120	15.0	24.8	2.05	31.3	Weld	0	-	27.3	574
					M20	1	22	24.3	510
					M24	1	26	23.6	495
150 x 150	8.0	17.9	2.87	22.7	Weld	0	-	19.5	408
					M20	1	22	17.3	364
					M20	2	22	15.5	325
					M24	1	26	17.2	362
150 x 150	10.0	22.1	2.82	27.9	Weld	0	-	24.0	505
					M20	1	22	21.5	450
					M20	2	22	19.2	402
					M24	1	26	21.3	448

The capacity of the bolts must also be checked.

For explanation of table see Section 8.5

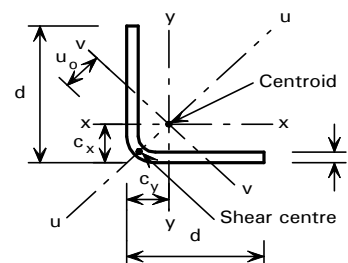
Table 32**TENSION****EQUAL ANGLES
SUBJECT TO AXIAL TENSION****TENSION CAPACITY FOR GRADE 1.4301 (304)**

d x d mm	t mm	Mass per Metre kg	Radius of Gyration v-v axis cm	Gross Area cm ²	Weld or Bolt Size	Holes Deducted From Angle		Equivalent Tension Area cm ²	Tension Capacity kN
						No.	Diameter mm		
150 x 150	12.0	26.1	2.76	33.0	Weld	0	-	28.5	598
					M20	1	22	25.5	535
					M20	2	22	22.8	478
					M24	1	26	25.4	532
150 x 150	15.0	31.9	2.67	40.3	Weld	0	-	35.0	734
					M20	1	22	31.4	659
					M20	2	22	28.0	587
					M24	1	26	31.2	655
200 x 200	8.0	24.2	3.90	30.7	Weld	0	-	26.3	551
					M20	3	22	20.2	424
					M24	1	26	23.3	490
					M24	2	26	21.5	452
200 x 200	10.0	30.0	3.85	37.9	Weld	0	-	32.5	683
					M20	3	22	25.0	525
					M24	1	26	29.0	608
					M24	2	26	26.7	561
200 x 200	12.0	35.6	3.79	45.0	Weld	0	-	38.7	812
					M20	3	22	29.8	625
					M24	1	26	34.5	724
					M24	2	26	31.8	668
200 x 200	15.0	43.7	3.71	55.3	Weld	0	-	47.7	1000
					M20	3	22	36.8	772
					M24	1	26	42.7	896
					M24	2	26	39.3	825

The capacity of the bolts must also be checked.

For explanation of table see Section 8.5

Table 33

TENSION
TWO EQUAL ANGLES
BACK TO BACK
SUBJECT TO AXIAL TENSION

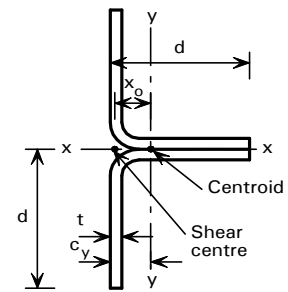

TENSION CAPACITY FOR GRADE 1.4301 (304)

2d x d mm	t mm	Mass per Metre kg	Radius of Gyration		Gross Area cm ²	Weld or Bolt Size	Holes Deducted From Angle		Gusset Between Angles		Gusset On Back of Angles	
			Axis x-x cm	Axis y-y cm			No.	Diameter mm	Equivalent Tension Area cm ²	Tension Capacity kN	Equivalent Tension Area cm ²	Tension Capacity kN
100 x 50	5.0	7.08	2.17	1.55	8.96	Weld M12	0	-	8.37	175	7.77	163
							1	13	7.41	155	6.42	134
100 x 50	6.0	8.30	2.20	1.53	10.5	Weld M12	0	-	9.83	206	9.16	192
							1	13	8.71	182	7.58	159
100 x 50	8.0	10.5	2.26	1.50	13.3	Weld M12	0	-	12.5	263	11.7	246
							1	13	11.1	233	9.78	205
100 x 50	10.0	12.5	2.34	1.47	15.9	Weld M12	0	-	15.0	314	14.1	296
							1	13	13.3	278	11.8	247
150 x 75	6.0	13.0	3.21	2.34	16.5	Weld M16	0	-	15.4	323	14.3	299
							1	18	13.8	290	12.0	251
							1	22	13.3	278	11.4	239
150 x 75	8.0	16.9	3.27	2.31	21.3	Weld M16	0	-	19.9	418	18.5	389
							1	18	18.0	377	15.6	327
							1	22	17.2	360	14.8	311
150 x 75	10.0	20.4	3.33	2.28	25.9	Weld M16	0	-	24.2	508	22.6	474
							1	18	21.8	458	19.1	401
							1	22	20.9	438	18.1	381
150 x 75	12.0	23.7	3.40	2.25	30.0	Weld M16	0	-	28.2	592	26.4	554
							1	18	25.4	534	22.4	471
							1	22	24.3	510	21.3	446
200 x 100	8.0	23.2	4.28	3.12	29.3	Weld M20	0	-	27.3	574	25.3	532
							1	22	25.0	524	21.6	454
							1	26	24.2	508	20.9	438
200 x 100	10.0	28.3	4.33	3.09	35.9	Weld M20	0	-	33.5	702	31.1	653
							1	22	30.6	642	26.6	559
							1	26	29.7	622	25.7	539
200 x 100	12.0	33.2	4.40	3.06	42.0	Weld M20	0	-	39.3	825	36.6	769
							1	22	36.0	755	31.5	661
							1	26	34.8	731	30.3	636
200 x 100	15.0	40.0	4.49	3.02	50.7	Weld M20	0	-	47.6	998	44.5	933
							1	22	43.6	915	38.4	806
							1	26	42.1	885	37.0	776
240 x 120	8.0	28.2	5.09	3.77	35.7	Weld M20	0	-	33.3	698	30.8	646
							1	22	31.2	655	27.1	568
							1	26	30.5	639	26.3	552
240 x 120	10.0	34.6	5.14	3.74	43.9	Weld M20	0	-	40.9	858	37.9	795
							1	22	38.4	806	33.4	702
							1	26	37.5	786	32.5	682
240 x 120	12.0	40.8	5.20	3.71	51.6	Weld M20	0	-	48.2	1010	44.8	940
							1	22	45.3	952	39.6	832
							1	26	44.2	928	38.5	808
240 x 120	15.0	49.5	5.29	3.67	62.7	Weld M20	0	-	58.7	1230	54.7	1150
							1	22	55.3	1160	48.6	1020
							1	26	53.8	1130	47.2	990
300 x 150	8.0	35.8	6.31	4.74	45.3	Weld M20	0	-	42.1	885	38.9	817
							1	22	40.0	840	34.7	728
							2	22	36.4	763	31.0	651
							1	26	39.8	836	34.5	724
300 x 150	10.0	44.1	6.36	4.71	55.9	Weld M20	0	-	52.0	1090	48.1	1010
							1	22	49.4	1040	42.9	901
							2	22	44.8	941	38.4	805
							1	26	49.2	1030	42.7	896

The capacity of the bolts must also be checked.

For explanation of table see Section 8.5

Table 33

TENSION

TWO EQUAL ANGLES
BACK TO BACK
SUBJECT TO AXIAL TENSION

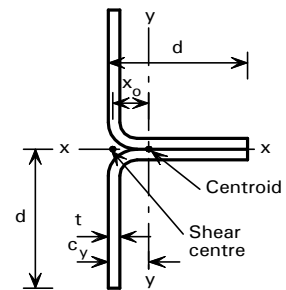

TENSION CAPACITY FOR GRADE 1.4301 (304)

2d x d mm	t mm	Mass per Metre kg	Radius of Gyration		Gross Area cm ²	Weld or Bolt Size	Holes Deducted From Angle		Gusset Between Angles		Gusset On Back of Angles	
			Axis x-x cm	Axis y-y cm			No.	Diameter mm	Equivalent Tension Area cm ²	Tension Capacity kN	Equivalent Tension Area cm ²	Tension Capacity kN
300 x 150	12.0	52.2	6.42	4.68	66.0	Weld	0	-	61.5	1290	57.0	1200
						M20	1	22	58.5	1230	51.0	1070
						M20	2	22	53.1	1110	45.5	956
						M24	1	26	58.2	1220	50.7	1070
300 x 150	15.0	63.7	6.50	4.64	80.7	Weld	0	-	75.3	1580	70.0	1470
						M20	1	22	71.8	1510	62.8	1320
						M20	2	22	64.9	1360	56.0	1180
						M24	1	26	71.4	1500	62.5	1310
400 x 200	8.0	48.5	8.35	6.35	61.3	Weld	0	-	56.9	1200	52.5	1100
						M20	3	22	47.7	1000	40.4	848
						M24	1	26	54.0	1130	46.7	980
						M24	2	26	50.4	1060	43.1	904
400 x 200	10.0	59.9	8.40	6.32	75.9	Weld	0	-	70.5	1480	65.1	1370
						M20	3	22	59.1	1240	50.1	1050
						M24	1	26	66.9	1400	57.9	1220
						M24	2	26	62.4	1310	53.4	1120
400 x 200	12.0	71.1	8.45	6.30	90.0	Weld	0	-	83.7	1760	77.4	1630
						M20	3	22	70.1	1470	59.6	1250
						M24	1	26	79.5	1670	69.0	1450
						M24	2	26	74.1	1560	63.6	1340
400 x 200	15.0	87.4	8.53	6.26	110	Weld	0	-	103	2160	95.5	2000
						M20	3	22	86.2	1810	73.6	1550
						M24	1	26	98.0	2060	85.3	1790
						M24	2	26	91.3	1920	78.6	1650

The capacity of the bolts must also be checked.

For explanation of table see Section 8.5

Table 34

BENDING

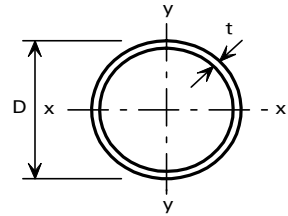
CIRCULAR HOLLOW SECTIONS
SUBJECT TO BENDING

MOMENT AND SHEAR CAPACITY FOR GRADE 1.4301 (304)

D mm	t mm	Mass per Metre kg	Section Classification	Moment Capacity M_c kNm	Second Moment Of Area I_x, I_y cm ⁴	Shear Capacity P_v kN
21.3	1.0	0.50	Plastic	<i>0.0779</i>	0.329	4.82
	1.2	0.60	Plastic	<i>0.0909</i>	0.384	5.73
	1.6	0.78	Plastic	<i>0.114</i>	0.484	7.49
	2.0	0.96	Plastic	<i>0.135</i>	0.571	9.17
	2.3	1.08	Plastic	<i>0.149</i>	0.629	10.4
33.7	1.0	0.81	Plastic	<i>0.206</i>	1.37	7.77
	1.6	1.27	Plastic	<i>0.312</i>	2.08	12.2
	2.0	1.57	Plastic	<i>0.376</i>	2.51	15.1
	2.5	1.94	Plastic	<i>0.449</i>	3.00	18.5
	3.2	2.42	Plastic	<i>0.539</i>	3.60	23.2
42.4	1.0	1.03	Plastic	<i>0.331</i>	2.79	9.83
	1.6	1.62	Plastic	<i>0.508</i>	4.27	15.5
	2.0	2.01	Plastic	<i>0.617</i>	5.19	19.2
	2.6	2.57	Plastic	<i>0.768</i>	6.46	24.6
	3.2	3.11	Plastic	<i>0.906</i>	7.62	29.8
48.3	1.0	1.17	Plastic	<i>0.434</i>	4.16	11.2
	1.6	1.85	Plastic	<i>0.669</i>	6.41	17.7
	2.0	2.30	Plastic	<i>0.815</i>	7.81	22.0
	2.6	2.95	Plastic	<i>1.02</i>	9.78	28.2
	3.2	3.58	Plastic	<i>1.21</i>	11.6	34.3
60.3	1.0	1.47	Compact	<i>0.685</i>	8.19	14.1
	1.6	2.33	Plastic	<i>1.06</i>	12.7	22.3
	2.0	2.89	Plastic	<i>1.30</i>	15.6	27.7
	2.6	3.72	Plastic	<i>1.64</i>	19.7	35.6
	3.2	4.53	Plastic	<i>1.96</i>	23.5	43.4
	4.0	5.59	Plastic	<i>2.35</i>	28.2	53.5
	5.0	6.86	Plastic	<i>2.80</i>	33.5	65.7
76.1	1.0	1.86	Semi-compact	0.918	16.6	17.8
	1.6	2.96	Plastic	<i>1.72</i>	26.0	28.3
	2.0	3.68	Plastic	<i>2.12</i>	32.0	35.2
	2.6	4.74	Plastic	<i>2.69</i>	40.6	45.4
	3.2	5.79	Plastic	<i>3.23</i>	48.8	55.4
	4.0	7.16	Plastic	<i>3.91</i>	59.1	68.5
	5.0	8.82	Plastic	<i>4.70</i>	70.9	84.4
88.9	1.0	2.18	Semi-compact	1.26	26.7	20.9
	1.6	3.47	Compact	2.37	41.8	33.2
	2.0	4.31	Plastic	<i>2.92</i>	51.6	41.3
	2.6	5.57	Plastic	<i>3.72</i>	65.7	53.3
	3.2	6.81	Plastic	<i>4.49</i>	79.2	65.1
	4.0	8.43	Plastic	<i>5.46</i>	96.3	80.7
	5.0	10.4	Plastic	<i>6.60</i>	116	99.6
101.6	1.0	2.50	Semi-compact	1.65	40.0	23.9
	1.6	3.97	Compact	3.12	62.8	38.0
	2.0	4.94	Plastic	<i>3.85</i>	77.6	47.3
	2.6	6.39	Plastic	<i>4.92</i>	99.1	61.1
	3.2	7.81	Plastic	<i>5.95</i>	119	74.8
	4.0	9.69	Plastic	<i>7.26</i>	146	92.7
	5.0	12.0	Plastic	<i>8.80</i>	177	114

M_c values in *italic type* are governed by $1.2p_y Z$ and a higher value may be used in some circumstances.

For explanation of table see Section 8.6.

Table 34

BENDING

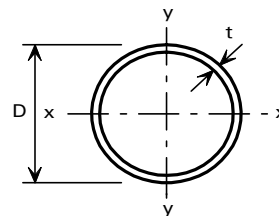
CIRCULAR HOLLOW SECTIONS
SUBJECT TO BENDING

MOMENT AND SHEAR CAPACITY FOR GRADE 1.4301 (304)

D mm	t mm	Mass per Metre kg	Section Classification	Moment Capacity M_c kNm	Second Moment Of Area I_x, I_y cm ⁴	Shear Capacity P_v kN
114.3	1.2	3.37	Semi-compact	2.51	68.2	32.2
	1.6	4.48	Compact	3.97	90.0	42.8
	2.0	5.57	Compact	<i>4.91</i>	111	53.3
	2.6	7.21	Plastic	<i>6.28</i>	142	69.0
	3.2	8.82	Plastic	<i>7.60</i>	172	84.4
	4.0	10.9	Plastic	<i>9.31</i>	211	104
139.7	5.0	13.6	Plastic	<i>11.3</i>	256	129
	1.2	4.12	Semi-compact	3.76	125	39.5
	1.6	5.48	Semi-compact	4.98	165	52.5
	2.0	6.84	Compact	<i>7.40</i>	205	65.4
	2.6	8.85	Compact	<i>9.50</i>	263	84.7
	3.2	10.8	Plastic	<i>11.5</i>	319	103
168.3	4.0	13.5	Plastic	<i>14.2</i>	392	128
	5.0	16.7	Plastic	<i>17.3</i>	480	159
	1.6	6.62	Semi-compact	7.26	291	63.3
	2.0	8.25	Semi-compact	9.02	361	79.0
	2.6	10.7	Compact	<i>13.9</i>	464	102
	3.2	13.1	Compact	<i>16.9</i>	565	125
219.1	4.0	16.3	Plastic	<i>20.9</i>	697	156
	5.0	20.3	Plastic	<i>25.6</i>	855	193
	2.0	10.8	Semi-compact	15.4	803	103
	2.6	14.0	Semi-compact	19.9	1040	133
	3.2	17.1	Compact	<i>29.1</i>	1260	164
	4.0	21.4	Compact	<i>36.0</i>	1560	204
273	5.0	26.6	Plastic	<i>44.4</i>	1930	254
	2.6	17.4	Semi-compact	31.1	2020	166
	3.2	21.4	Semi-compact	38.0	2470	205
	4.0	26.7	Compact	<i>56.5</i>	3060	255
	5.0	33.3	Compact	<i>69.8</i>	3780	318

M_c values in *italic type* are governed by $1.2p_y Z$ and a higher value may be used in some circumstances.

For explanation of table see Section 8.6.

Table 35

BENDING

**RECTANGULAR HOLLOW SECTIONS
SUBJECT TO BENDING**

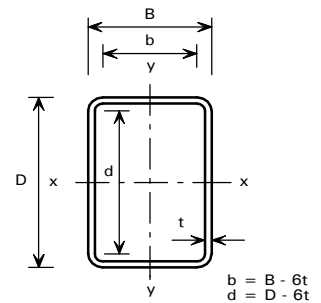

MOMENT CAPACITY AND LIMITING LENGTHS FOR GRADE 1.4301 (304)

D x B mm	t mm	Mass per Metre kg	Section Classification		Moment Capacity		Limiting Length L _c m	Second Moment Of Area		Shear Capacity P _v kN
			Bending About x-x Axis	Bending About y-y Axis	M _{cx} kNm	M _{cy} kNm		I _x cm ⁴	I _y cm ⁴	
50 x 25	1.5	1.63	Plastic	Compact	<i>0.646</i>	0.421	4.84	6.41	2.19	17.3
	2.0	2.11	Plastic	Plastic	<i>0.801</i>	0.531	4.81	7.95	2.70	22.4
60 x 30	2.0	2.58	Plastic	Plastic	<i>1.21</i>	0.794	5.80	14.4	4.92	27.5
	3.0	3.68	Plastic	Plastic	<i>1.60</i>	<i>1.08</i>	5.73	19.1	6.44	39.1
80 x 40	2.0	3.53	Plastic	Slender	<i>2.28</i>	1.27	7.77	36.2	12.4	37.5
	3.0	5.10	Plastic	Plastic	<i>3.13</i>	2.07	7.71	49.7	16.9	54.2
	4.0	6.54	Plastic	Plastic	<i>3.80</i>	2.56	7.63	60.3	20.4	69.5
100 x 50	2.0	4.48	Plastic	Slender	<i>3.69</i>	1.82	9.73	73.2	25.2	47.6
	3.0	6.52	Plastic	Compact	<i>5.17</i>	3.37	9.69	102	35.1	69.3
	4.0	8.43	Plastic	Plastic	<i>6.41</i>	4.25	9.62	127	43.2	89.7
	5.0	10.2	Plastic	Plastic	<i>7.42</i>	5.01	9.54	147	49.7	108
150 x 75	6.0	11.9	Plastic	Plastic	<i>8.21</i>	5.52	9.44	162	54.7	126
	3.0	10.1	Plastic	Slender	<i>12.5</i>	6.16	14.6	370	127	107
	4.0	13.2	Plastic	Semi-compact	<i>15.9</i>	9.07	14.6	472	161	140
	5.0	16.1	Plastic	Plastic	<i>18.9</i>	12.4	14.5	563	192	171
	6.0	19.0	Plastic	Plastic	<i>21.6</i>	14.3	14.4	643	218	201
150 x 100	8.0	24.2	Plastic	Plastic	<i>26.0</i>	17.5	14.3	774	260	257
	3.0	11.3	Compact	Slender	<i>15.2</i>	8.91	28.4	451	243	107
	4.0	14.8	Plastic	Semi-compact	<i>19.5</i>	13.1	28.5	578	311	141
	5.0	18.1	Plastic	Plastic	<i>23.3</i>	18.1	28.6	694	373	173
	6.0	21.3	Plastic	Plastic	<i>26.9</i>	21.0	28.7	799	428	204
200 x 100	8.0	27.4	Plastic	Plastic	<i>32.8</i>	26.2	28.8	976	521	262
	4.0	17.9	Plastic	Slender	<i>29.5</i>	14.6	19.5	1170	403	190
	5.0	22.1	Plastic	Slender	<i>35.7</i>	19.8	19.4	1420	485	234
	6.0	26.1	Plastic	Compact	<i>41.3</i>	27.0	19.4	1640	561	277
	8.0	33.7	Plastic	Plastic	<i>51.3</i>	34.0	19.2	2030	690	358
200 x 125	10.0	40.8	Plastic	Plastic	<i>59.4</i>	40.1	19.1	2360	795	434
	4.0	19.5	Plastic	Slender	<i>34.4</i>	19.4	32.2	1360	666	191
	5.0	24.0	Plastic	Slender	<i>41.7</i>	26.3	32.2	1650	805	235
	6.0	28.5	Plastic	Compact	<i>48.5</i>	36.0	32.3	1920	935	279
	8.0	36.9	Plastic	Plastic	<i>60.6</i>	45.7	32.4	2400	1160	362
250 x 125	10.0	44.8	Plastic	Plastic	<i>70.7</i>	54.3	32.4	2810	1360	439
	6.0	33.2	Plastic	Slender	<i>67.4</i>	36.6	24.3	3340	1150	352
	8.0	43.2	Plastic	Plastic	<i>84.9</i>	55.5	24.2	4210	1440	459
	10.0	52.7	Plastic	Plastic	<i>100</i>	66.4	24.1	4970	1690	560
	12.0	61.7	Plastic	Plastic	<i>113</i>	76.0	23.9	5610	1900	655
250 x 150	15.0	74.1	Plastic	Plastic	<i>128</i>	86.2	23.6	6360	2140	788
	6.0	35.6	Plastic	Slender	<i>76.4</i>	46.1	36.5	3790	1730	354
	8.0	46.4	Plastic	Plastic	<i>96.7</i>	70.4	36.6	4800	2190	462
	10.0	56.6	Plastic	Plastic	<i>114</i>	84.5	36.6	5690	2580	564
	12.0	66.4	Plastic	Plastic	<i>130</i>	97.3	36.6	6460	2930	661
300 x 150	15.0	80.1	Plastic	Plastic	<i>149</i>	112	36.5	7400	3340	798
	6.0	40.3	Plastic	Slender	<i>99.7</i>	49.2	29.2	5930	2040	428
	8.0	52.7	Plastic	Semi-compact	<i>126</i>	72.5	29.1	7560	2590	560
	10.0	64.5	Plastic	Plastic	<i>151</i>	99.2	29.0	9010	3070	686
	12.0	75.9	Plastic	Plastic	<i>173</i>	114	28.9	10300	3500	806
300 x 200	15.0	91.9	Plastic	Plastic	<i>200</i>	135	28.6	11900	4030	977
	6.0	45.0	Compact	Slender	<i>121</i>	71.3	56.8	7230	3900	431
	8.0	59.0	Plastic	Semi-compact	<i>155</i>	104	57.0	9260	4990	564
	10.0	72.4	Plastic	Plastic	<i>186</i>	144	57.2	11100	5970	693
	12.0	85.4	Plastic	Plastic	<i>214</i>	168	57.3	12800	6850	816
300 x 200	15.0	103	Plastic	Plastic	<i>251</i>	200	57.5	15000	8000	992

Moment capacity values in *italic type* are governed by 1.2p_yZ and a higher value may be used in some circumstances.

Lengths above the limiting length L_c should be checked for lateral torsional buckling.

For explanation of table see Section 8.6.

Table 35

BENDING

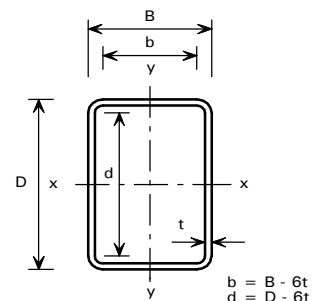
RECTANGULAR HOLLOW SECTIONS
SUBJECT TO BENDING

MOMENT CAPACITY AND LIMITING LENGTHS FOR GRADE 1.4301 (304)

D x B mm	t mm	Mass per Metre kg	Section Classification		Moment Capacity		Limiting Length L_c m	Second Moment Of Area		Shear Capacity P_v kN
			Bending About x-x Axis	Bending About y-y Axis	M_{cx} kNm	M_{cy} kNm		I_x cm ⁴	I_y cm ⁴	
350 x 175	6.0	47.4	Plastic	Slender	<i>138</i>	63.0	34.1	9600	3320	504
	8.0	62.2	Plastic	Slender	<i>177</i>	94.0	34.0	12300	4240	661
	10.0	76.4	Plastic	Semi-compact	<i>213</i>	121	33.9	14800	5070	812
	12.0	90.1	Plastic	Plastic	<i>245</i>	161	33.8	17100	5810	958
	15.0	109	Plastic	Plastic	<i>288</i>	191	33.6	20000	6780	1170
350 x 200	6.0	49.8	Compact	Slender	<i>151</i>	74.8	45.6	10500	4460	505
	8.0	65.3	Plastic	Slender	<i>194</i>	111	45.6	13500	5720	663
	10.0	80.3	Plastic	Semi-compact	<i>233</i>	144	45.7	16200	6870	815
	12.0	94.8	Plastic	Plastic	<i>270</i>	191	45.6	18800	7920	962
	15.0	115	Plastic	Plastic	<i>318</i>	229	45.6	22100	9290	1170
400 x 200	6.0	54.5	Compact	Slender	<i>183</i>	77.7	39.0	14500	5030	579
	8.0	71.6	Plastic	Slender	<i>236</i>	116	38.9	18800	6460	761
	10.0	88.2	Plastic	Slender	<i>285</i>	158	38.8	22700	7780	938
	12.0	104	Plastic	Compact	<i>330</i>	215	38.7	26200	8980	1110
	15.0	127	Plastic	Plastic	<i>391</i>	258	38.6	31100	10600	1360
400 x 250	6.0	59.3	Slender	Slender	170	103	99.2	16900	8250	581
	8.0	78.0	Plastic	Slender	274	155	64.4	21800	10700	765
	10.0	96.1	Plastic	Slender	333	210	64.5	26500	12900	943
	12.0	113	Plastic	Compact	387	288	64.6	30800	15000	1120
	15.0	139	Plastic	Plastic	461	347	64.7	36600	17800	1370

Moment capacity values in *italic type* are governed by $1.2p_y Z$ and a higher value may be used in some circumstances.

Lengths above the limiting length L_c should be checked for lateral torsional buckling.

For explanation of table see Section 8.6.

Table 36

BENDING

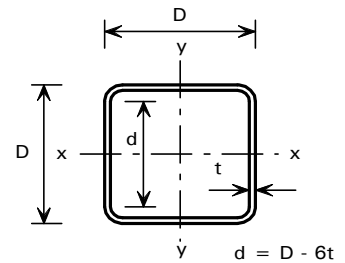
SQUARE HOLLOW SECTIONS
SUBJECT TO BENDING

MOMENT AND SHEAR CAPACITY FOR GRADE 1.4301 (304)

D x D mm	t mm	Mass per Metre kg	Section Classification	Moment Capacity M_c kNm	Second Moment Of Area I_x, I_y cm ⁴	Shear Capacity P_v kN
40 x 40	2.0	2.27	Plastic	<i>0.839</i>	6.66	18.1
	3.0	3.20	Plastic	<i>1.09</i>	8.69	25.5
50 x 50	2.0	2.90	Plastic	<i>1.36</i>	13.7	23.1
	3.0	4.15	Plastic	<i>1.86</i>	18.5	33.1
	4.0	5.27	Plastic	<i>2.21</i>	22.0	42.0
60 x 60	2.0	3.53	Plastic	<i>2.01</i>	24.5	28.2
	3.0	5.10	Plastic	<i>2.83</i>	33.7	40.7
	4.0	6.54	Plastic	<i>3.45</i>	41.0	52.1
	5.0	7.84	Plastic	<i>3.91</i>	46.5	62.5
80 x 80	2.0	4.79	Slender	3.10	60.6	38.2
	3.0	6.99	Plastic	<i>5.28</i>	85.3	55.8
	4.0	9.06	Plastic	<i>6.71</i>	106	72.3
	5.0	11.0	Plastic	<i>7.84</i>	124	87.7
100 x 100	3.0	8.89	Compact	8.49	173	70.9
	4.0	11.6	Plastic	10.9	219	92.4
	5.0	14.2	Plastic	<i>13.1</i>	260	112
	6.0	16.6	Plastic	<i>14.9</i>	295	132
	8.0	21.1	Plastic	<i>17.7</i>	351	168
125 x 125	3.0	11.3	Slender	11.2	348	89.8
	4.0	14.8	Plastic	17.6	446	117
	5.0	18.1	Plastic	21.3	535	144
	6.0	21.3	Plastic	<i>24.8</i>	616	170
	8.0	27.4	Plastic	<i>30.4</i>	752	218
150 x 150	3.0	13.6	Slender	15.2	613	108
	4.0	17.9	Semi-compact	22.2	792	142
	5.0	22.1	Plastic	31.4	957	175
	6.0	26.1	Plastic	36.8	1110	207
	8.0	33.7	Plastic	<i>46.4</i>	1380	268
175 x 175	4.0	21.1	Slender	28.9	1280	168
	5.0	26.0	Semi-compact	37.4	1560	207
	6.0	30.8	Plastic	51.2	1820	245
	8.0	40.0	Plastic	65.3	2280	319
	10.0	48.7	Plastic	<i>77.3</i>	2680	388
200 x 200	4.0	24.2	Slender	36.1	1940	193
	5.0	30.0	Slender	48.4	2370	238
	6.0	35.6	Compact	67.9	2770	283
	8.0	46.4	Plastic	87.2	3510	369
	10.0	56.6	Plastic	<i>104</i>	4160	451
250 x 250	5.0	37.9	Slender	70.5	4740	301
	6.0	45.0	Slender	89.7	5570	359
	8.0	59.0	Plastic	140	7140	470
	10.0	72.4	Plastic	170	8570	577
	12.0	85.4	Plastic	<i>198</i>	9860	680
300 x 300	5.0	45.8	Slender	95.4	8320	364
	6.0	54.5	Slender	121	9820	434
	8.0	71.6	Semi-compact	177	12700	571
	10.0	88.2	Plastic	251	15300	703
	12.0	104	Plastic	<i>294</i>	17800	831
350 x 350	6.0	64.0	Slender	157	15800	510
	8.0	84.3	Slender	230	20500	672
	10.0	104	Semi-compact	299	24900	829
	12.0	123	Plastic	409	29100	983
	15.0	151	Plastic	<i>495</i>	34700	1210

M_c values in *italic type* are governed by $1.2p_y Z$ and a higher value may be used in some circumstances.

For explanation of table see Section 8.6.

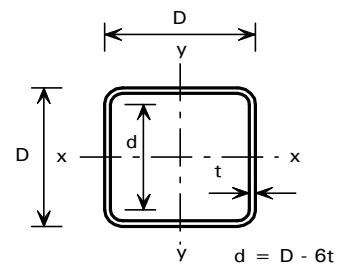
Table 36**BENDING****SQUARE HOLLOW SECTIONS
SUBJECT TO BENDING****MOMENT AND SHEAR CAPACITY FOR GRADE 1.4301 (304)**

D x D mm	t mm	Mass per Metre kg	Section Classification	Moment Capacity M_c kNm	Second Moment Of Area I_x, I_y cm^4	Shear Capacity P_v kN
400 x 400	6.0	73.5	Slender	196	23900	585
	8.0	96.9	Slender	288	31000	772
	10.0	119	Slender	387	37900	955
	12.0	142	Compact	543	44300	1130
	15.0	174	Plastic	660	53300	1390

M_c values in *italic type* are governed by $1.2p_y Z$ and a higher value may be used in some circumstances.

For explanation of table see Section 8.6.

Table 37

BENDING

**CHANNELS
SUBJECT TO BENDING**

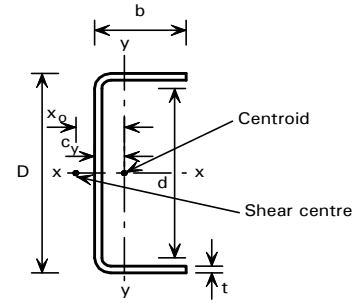

MOMENT CAPACITY AND BUCKLING RESISTANCE MOMENT FOR GRADE 1.4301 (304)

D x b mm	t mm	Section Classification	Moment Capacity		Buckling Resistance Moment, M_b (kNm)													Shear Capacity P_v kN	
			M_{cx} kNm	M_{cy} kNm	for Effective lengths, L_E (m)														
					1.0	1.5	2.0	2.5	3.0	3.5	4.0	5.0	6.0	7.0	8.0	9.0	10.0		
50 x 25	2.0	Slender Plastic	0.575	0.131	0.439	0.341	0.273	0.226	0.193	0.168	0.149	0.121	0.102	0.089	0.078	0.070	0.063	12.6	
	3.0		<i>0.931</i>	<i>0.227</i>	0.761	0.631	0.526	0.446	0.386	0.339	0.303	0.249	0.211	0.183	0.162	0.145	0.132	18.9	
75 x 35	3.0	Semi-compact	1.83	0.391	1.60	1.35	1.13	0.952	0.820	0.719	0.640	0.525	0.444	0.386	0.341	0.305	0.277	28.4	
	4.0	Plastic	2.73	<i>0.604</i>	2.41	2.08	1.78	1.53	1.34	1.18	1.06	0.873	0.743	0.647	0.572	0.514	0.466	37.8	
	5.0	Plastic	3.16	<i>0.729</i>	2.95	2.64	2.34	2.08	1.85	1.66	1.50	1.25	1.07	0.940	0.835	0.751	0.682	47.3	
100 x 50	3.0	Slender	3.24	0.507	3.11	2.77	2.40	2.05	1.77	1.54	1.36	1.11	0.933	0.806	0.711	0.635	0.575	37.8	
	4.0	Slender	4.60	1.05	4.39	3.96	3.51	3.09	2.73	2.43	2.18	1.81	1.54	1.34	1.19	1.07	0.969	50.4	
	5.0	Compact	6.55	<i>1.55</i>	6.20	5.59	5.00	4.45	3.96	3.55	3.21	2.68	2.30	2.01	1.78	1.60	1.46	63.0	
125 x 50	3.0	Slender	4.42	0.519	4.20	3.66	3.06	2.53	2.12	1.81	1.58	1.25	1.04	0.894	0.783	0.698	0.629	47.3	
	4.0	Slender	6.26	1.09	5.91	5.19	4.45	3.78	3.25	2.83	2.51	2.04	1.72	1.49	1.31	1.17	1.06	63.0	
	5.0	Compact	8.98	<i>1.61</i>	8.42	7.37	6.33	5.43	4.71	4.14	3.69	3.03	2.57	2.23	1.97	1.77	1.60	78.8	
	6.0	Plastic	10.3	<i>1.89</i>	9.85	8.82	7.81	6.89	6.10	5.44	4.90	4.08	3.48	3.04	2.70	2.42	2.20	94.5	
150 x 60	4.0	Slender	8.69	1.17	8.54	7.74	6.82	5.88	5.06	4.39	3.86	3.10	2.59	2.22	1.95	1.74	1.57	75.6	
	5.0	Semi-compact	11.2	1.97	11.0	9.98	8.91	7.84	6.89	6.09	5.43	4.45	3.77	3.27	2.89	2.59	2.34	94.5	
	6.0	Compact	15.5	<i>2.78</i>	15.1	13.7	12.1	10.7	9.38	8.33	7.46	6.16	5.23	4.55	4.03	3.61	3.28	113	
175 x 60	8.0	Plastic	19.1	<i>3.57</i>	19.1	17.7	16.3	14.9	13.6	12.4	11.3	9.62	8.32	7.32	6.53	5.89	5.36	151	
	5.0	Semi-compact	13.9	2.01	13.6	12.2	10.7	9.23	7.94	6.91	6.10	4.92	4.13	3.56	3.13	2.79	2.53	110	
	6.0	Compact	19.4	<i>2.84</i>	18.9	16.8	14.6	12.5	10.8	9.42	8.34	6.79	5.72	4.95	4.37	3.91	3.54	132	
	8.0	Plastic	24.0	<i>3.66</i>	24.0	21.9	19.7	17.6	15.8	14.2	12.8	10.7	9.17	8.02	7.12	6.40	5.82	176	
200 x 75	10.0	Plastic	27.8	<i>4.41</i>	27.8	26.6	24.6	22.6	20.8	19.1	17.5	15.0	13.0	11.5	10.3	9.26	8.44	220	
	5.0	Slender	18.6	2.30	18.6	17.6	16.1	14.4	12.7	11.2	9.88	7.92	6.58	5.63	4.92	4.37	3.94	126	
	6.0	Slender	23.1	3.70	23.1	21.8	20.0	18.0	16.1	14.3	12.8	10.5	8.83	7.63	6.72	6.00	5.43	151	
	8.0	Plastic	34.9	<i>5.80</i>	34.9	32.9	30.2	27.4	24.7	22.3	20.2	16.8	14.4	12.6	11.1	10.0	9.08	201	
225 x 75	10.0	Plastic	41.1	<i>7.04</i>	41.1	39.8	37.1	34.5	31.9	29.4	27.1	23.3	20.3	17.9	16.0	14.5	13.2	252	
	6.0	Slender	27.3	3.76	27.3	25.6	23.3	20.8	18.3	16.1	14.2	11.5	9.56	8.21	7.19	6.41	5.78	170	
	8.0	Plastic	41.4	<i>5.90</i>	41.4	38.9	35.3	31.5	28.0	24.9	22.3	18.4	15.6	13.5	11.9	10.7	9.67	226	
	10.0	Plastic	48.9	<i>7.17</i>	48.9	47.2	43.6	39.9	36.4	33.1	30.3	25.6	22.1	19.4	17.2	15.5	14.1	283	
250 x 100	12.0	Plastic	55.3	<i>8.37</i>	55.3	54.9	51.4	47.9	44.6	41.3	38.4	33.2	29.1	25.7	23.1	20.9	19.1	340	
	6.0	Slender	35.4	4.15	35.4	35.4	33.6	31.6	29.3	26.9	24.5	20.2	16.9	14.5	12.6	11.2	10.0	189	
	8.0	Slender	50.0	8.70	50.0	49.9	47.3	44.5	41.6	38.5	35.6	30.2	26.0	22.7	20.1	18.0	16.3	252	
	10.0	Compact	71.8	12.9	71.8	71.3	67.3	63.2	58.9	54.7	50.6	43.4	37.7	33.1	29.5	26.6	24.2	315	
300 x 100	12.0	Plastic	82.2	<i>15.1</i>	82.2	82.2	78.8	74.7	70.6	66.5	62.5	55.1	48.8	43.5	39.2	35.6	32.6	378	
	8.0	Slender	64.7	8.91	64.7	64.2	60.6	56.6	52.2	47.7	43.4	35.8	30.1	25.9	22.7	20.2	18.2	302	
	10.0	Compact	93.4	13.2	93.4	93.0	87.2	80.8	74.2	67.6	61.4	51.2	43.5	37.7	33.3	29.8	26.9	378	
	12.0	Plastic	107	<i>15.5</i>	107	107	102	95.7	89.1	82.5	76.3	65.4	56.7	49.8	44.4	40.0	36.4	453	
350 x 125	15.0	Plastic	125	<i>18.8</i>	125	125	123	117	110	104	98.5	87.2	77.5	69.3	62.6	56.9	52.2	567	
	8.0	Slender	87.8	9.64	87.8	87.8	86.8	82.9	78.7	74.1	69.1	59.1	50.2	43.0	37.4	33.0	29.5	352	
	10.0	Slender	114	17.3	114	114	112	107	102	96.5	90.5	78.5	67.9	59.2	52.3	46.7	42.2	441	
	12.0	Compact	159	<i>24.6</i>	159	159	156	148	140	131	122	106	92.0	80.6	71.5	64.1	58.2	529	
400 x 150	15.0	Plastic	189	<i>30.0</i>	189	189	189	189	180	172	163	154	138	123	110	99.4	90.4	82.7	661
	8.0	Slender	113	10.6	113	113	113	111	107	103	98.5	88.0	76.9	66.7	58.1	51.1	45.4	403	
	10.0	Slender	148	18.4	148	148	148	145	140	134	128	115	101	89.5	79.0	70.4	63.3	504	
	12.0	Slender	184	29.6	184	184	184	180	174	167	159	144	128	114	102	92.3	83.8	604	
400 x 150	15.0	Compact	265	43.9	265	265	265	259	248	238	226	204	182	163	147	133	122	756	

Section classification applies to bending about both the x-x and y-y axis.

Moment capacity values in *italic type* are governed by $1.2p_y Z$ and a higher value may be used in some circumstances.

M_b is obtained using an equivalent slenderness $= uv\lambda(\beta_w^{0.5})$.

In certain cases, M_b may be greater than M_{cx} , which implies that lateral torsional buckling is not critical.

For explanation of table see Section 8.6.

Table 38

BENDING

**DOUBLE CHANNELS BACK TO BACK
SUBJECT TO BENDING**

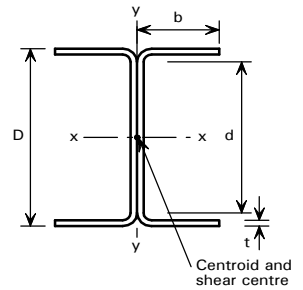

MOMENT CAPACITY AND BUCKLING RESISTANCE MOMENT FOR GRADE 1.4301 (304)

D x 2b mm	t mm	Section Classification	Moment Capacity		Buckling Resistance Moment, M_b (kNm)														Shear Capacity P_v kN
			M_{cx} kNm	M_{cy} kNm	for Effective lengths, L_E (m)														
					1.0	1.5	2.0	2.5	3.0	3.5	4.0	5.0	6.0	7.0	8.0	9.0	10.0		
50 x 50	2.0	Slender Plastic	1.12	0.334	0.902	0.719	0.593	0.505	0.439	0.389	0.350	0.292	0.250	0.220	0.196	0.177	0.161	25.2	
	3.0		<i>1.86</i>	<i>0.639</i>	1.58	1.33	1.14	1.000	0.889	0.799	0.727	0.615	0.533	0.471	0.422	0.383	0.350	37.8	
75 x 70	3.0	Slender	3.65	1.03	3.36	2.79	2.36	2.03	1.79	1.59	1.44	1.21	1.04	0.915	0.818	0.740	0.677	56.7	
	4.0	Compact	<i>5.46</i>	<i>1.67</i>	5.04	4.28	3.71	3.26	2.91	2.63	2.39	2.03	1.77	1.57	1.41	1.28	1.17	75.6	
	5.0	Plastic	<i>6.32</i>	<i>2.10</i>	6.19	5.44	4.86	4.38	3.99	3.66	3.37	2.92	2.57	2.29	2.07	1.89	1.74	94.5	
100 x 100	3.0	Slender	6.33	1.66	6.33	5.79	5.03	4.38	3.85	3.41	3.06	2.54	2.17	1.90	1.69	1.52	1.39	75.6	
	4.0	Slender	8.94	2.67	8.94	8.19	7.22	6.41	5.75	5.20	4.75	4.04	3.52	3.12	2.80	2.54	2.33	100	
	5.0	Semi-compact	10.9	3.54	10.9	10.2	9.21	8.37	7.65	7.05	6.52	5.68	5.02	4.51	4.08	3.74	3.44	126	
125 x 100	3.0	Slender	8.67	1.66	8.67	7.55	6.37	5.39	4.60	3.99	3.51	2.82	2.36	2.04	1.80	1.61	1.46	94.5	
	4.0	Slender	12.2	2.67	12.2	10.6	9.05	7.80	6.80	6.02	5.39	4.46	3.82	3.34	2.97	2.68	2.45	126	
	5.0	Semi-compact	15.0	3.54	15.0	13.2	11.6	10.2	9.10	8.20	7.46	6.32	5.49	4.86	4.36	3.96	3.63	157	
	6.0	Plastic	<i>20.6</i>	<i>5.13</i>	20.9	18.1	15.9	14.1	12.6	11.4	10.4	8.90	7.76	6.89	6.20	5.63	5.17	189	
150 x 120	4.0	Slender	17.0	3.41	17.0	16.0	14.0	12.2	10.6	9.38	8.35	6.81	5.76	4.99	4.41	3.96	3.59	151	
	5.0	Slender	22.1	4.95	22.1	20.7	18.2	16.0	14.2	12.7	11.5	9.59	8.24	7.23	6.46	5.84	5.33	189	
	6.0	Semi-compact	25.9	6.13	25.9	24.5	21.8	19.6	17.6	16.0	14.7	12.5	10.9	9.70	8.73	7.94	7.29	226	
	8.0	Plastic	<i>38.2</i>	<i>9.90</i>	39.4	37.0	33.2	30.2	27.6	25.4	23.5	20.4	18.1	16.2	14.7	13.4	12.4	302	
175 x 120	5.0	Slender	27.5	4.96	27.5	25.1	21.7	18.8	16.4	14.5	12.9	10.6	8.96	7.79	6.91	6.21	5.65	220	
	6.0	Semi-compact	32.3	6.14	32.3	29.8	26.1	23.0	20.4	18.2	16.5	13.8	11.9	10.5	9.36	8.47	7.74	264	
	8.0	Plastic	<i>48.0</i>	<i>9.93</i>	49.9	45.1	39.8	35.5	31.9	29.0	26.5	22.6	19.8	17.6	15.8	14.4	13.2	352	
	10.0	Plastic	<i>55.7</i>	<i>12.6</i>	59.0	55.1	49.8	45.4	41.8	38.6	35.9	31.4	27.9	25.1	22.8	20.9	19.3	441	
200 x 150	5.0	Slender	36.4	6.65	36.4	36.4	33.0	29.4	26.2	23.4	20.9	17.1	14.4	12.4	10.9	9.79	8.86	252	
	6.0	Slender	45.1	9.03	45.1	45.1	40.7	36.5	32.7	29.4	26.6	22.2	19.0	16.6	14.7	13.3	12.1	302	
	8.0	Compact	<i>69.9</i>	<i>15.4</i>	71.1	69.6	62.2	55.8	50.4	45.7	41.7	35.5	30.8	27.3	24.5	22.3	20.4	403	
	10.0	Plastic	<i>82.1</i>	<i>19.4</i>	84.9	84.3	76.6	70.0	64.3	59.4	55.2	48.2	42.8	38.5	35.0	32.0	29.6	504	
225 x 150	6.0	Slender	53.3	9.03	53.3	53.0	47.2	41.8	37.1	33.0	29.6	24.3	20.5	17.8	15.7	14.1	12.8	340	
	8.0	Compact	<i>82.9</i>	<i>15.4</i>	84.9	81.6	72.2	64.0	57.0	51.1	46.2	38.7	33.3	29.2	26.1	23.6	21.5	453	
	10.0	Plastic	<i>97.9</i>	<i>19.4</i>	101	99.1	89.0	80.4	73.0	66.8	61.4	52.9	46.4	41.4	37.4	34.1	31.3	567	
	12.0	Plastic	<i>110</i>	<i>23.6</i>	116	115	105	96.6	89.2	82.8	77.2	68.0	60.6	54.7	49.9	45.8	42.4	680	
250 x 200	6.0	Slender	69.4	13.3	69.4	69.4	69.4	65.6	60.4	55.5	51.0	43.1	36.8	31.9	28.1	25.0	22.6	378	
	8.0	Slender	97.6	21.4	97.6	97.6	97.6	91.6	84.6	78.2	72.4	62.4	54.4	48.1	43.1	39.0	35.7	504	
	10.0	Semi-compact	119	28.4	119	119	119	113	105	98.8	92.5	81.6	72.8	65.6	59.7	54.7	50.6	630	
	12.0	Plastic	<i>164</i>	<i>41.1</i>	168	168	167	155	144	135	126	112	100	91.4	83.5	76.9	71.2	756	
300 x 200	8.0	Slender	126	21.4	126	126	125	115	105	96.2	88.0	74.0	63.3	55.0	48.6	43.6	39.5	604	
	10.0	Semi-compact	155	28.4	155	155	155	142	131	121	112	96.8	84.6	75.0	67.4	61.2	56.0	756	
	12.0	Plastic	<i>214</i>	<i>41.2</i>	221	221	214	196	180	166	154	133	117	104	94.1	85.7	78.8	907	
	15.0	Plastic	<i>251</i>	<i>52.2</i>	264	264	259	240	224	210	197	175	157	143	130	120	111	1130	
350 x 250	8.0	Slender	172	28.8	172	172	172	172	162	151	141	121	105	92.1	81.1	72.3	65.1	705	
	10.0	Slender	223	41.8	223	223	223	223	209	195	182	159	139	123	110	99.5	90.6	882	
	12.0	Semi-compact	266	53.2	266	266	266	266	250	235	220	195	173	155	141	128	118	1060	
	15.0	Plastic	<i>379</i>	<i>80.4</i>	389	389	389	381	356	334	314	279	250	226	206	189	175	1320	
400 x 300	8.0	Slender	222	37.0	222	222	222	222	222	215	203	181	160	142	126	112	101	806	
	10.0	Slender	291	53.2	291	291	291	291	291	279	264	235	209	186	167	150	137	1010	
	12.0	Slender	360	72.2	360	360	360	360	360	344	325	291	261	235	212	193	177	1210	
	15.0	Semi-compact	443	95.8	443	443	443	443	443	426	405	367	334	305	280	258	240	1510	

Section classification applies to bending about both the x-x and y-y axis.

Moment capacity values in *italic type* are governed by $1.2p_y Z$ and a higher value may be used in some circumstances.

M_b is obtained using an equivalent slenderness $= \nu \lambda (\beta_w)^{0.5}$.

In certain cases, M_b may be greater than M_{cx} , which implies that lateral torsional buckling is not critical.

For explanation of table see Section 8.6.

[Blank Page]

D. MEMBER CAPACITIES

GRADE 1.4401 (316) and 1.4404 (316L)

Table 39

COMPRESSION

**CIRCULAR HOLLOW SECTIONS
SUBJECT TO AXIAL COMPRESSION**

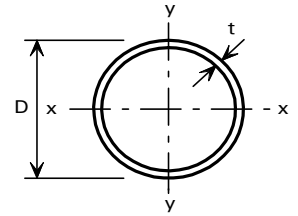

COMPRESSION RESISTANCE FOR GRADE 1.4401 (316) and 1.4404 (316L)

D mm	t mm	Mass per Metre kg	Compression Resistance P_c (kN)												
			for Effective Length L_e (m)												
			1.0	1.5	2.0	2.5	3.0	3.5	4.0	5.0	6.0	7.0	8.0	9.0	10.0
21.3	1.0	0.50	4.75	2.37	1.40	0.923	0.653	0.486	0.376	0.244	0.171	0.127	0.098	0.077	0.063
	1.2	0.60	5.56	2.77	1.64	1.08	0.762	0.568	0.439	0.285	0.200	0.148	0.114	0.090	0.073
	1.6	0.78	7.06	3.50	2.07	1.36	0.961	0.716	0.554	0.359	0.252	0.186	0.143	0.114	0.093
	2.0	0.96	8.38	4.15	2.44	1.61	1.14	0.846	0.654	0.425	0.298	0.220	0.169	0.134	0.109
	2.3	1.08	9.28	4.58	2.70	1.77	1.25	0.933	0.721	0.468	0.328	0.243	0.187	0.148	0.120
33.7	1.0	0.81	14.6	8.56	5.32	3.59	2.57	1.93	1.50	0.984	0.694	0.516	0.398	0.317	0.258
	1.6	1.27	22.6	13.1	8.11	5.45	3.91	2.93	2.28	1.49	1.05	0.783	0.604	0.481	0.391
	2.0	1.57	27.5	15.9	9.80	6.59	4.72	3.54	2.76	1.80	1.27	0.944	0.729	0.580	0.472
	2.5	1.94	33.3	19.1	11.8	7.90	5.65	4.24	3.30	2.16	1.52	1.13	0.872	0.693	0.564
	3.2	2.42	40.7	23.1	14.2	9.52	6.81	5.11	3.97	2.60	1.83	1.36	1.05	0.833	0.678
42.4	1.0	1.03	22.6	15.2	9.99	6.89	5.00	3.78	2.96	1.95	1.38	1.03	0.795	0.634	0.517
	1.6	1.62	35.3	23.5	15.4	10.6	7.68	5.81	4.54	2.99	2.12	1.58	1.22	0.972	0.793
	2.0	2.01	43.4	28.8	18.8	12.9	9.35	7.07	5.53	3.64	2.57	1.92	1.48	1.18	0.963
	2.6	2.57	55.0	36.2	23.5	16.1	11.7	8.82	6.89	4.54	3.21	2.39	1.85	1.47	1.20
	3.2	3.11	66.0	43.0	27.9	19.1	13.8	10.4	8.14	5.36	3.79	2.82	2.18	1.74	1.42
48.3	1.0	1.17	27.9	20.4	14.0	9.86	7.23	5.50	4.32	2.86	2.03	1.51	1.17	0.936	0.764
	1.6	1.85	43.8	31.7	21.7	15.3	11.2	8.49	6.67	4.41	3.13	2.34	1.81	1.44	1.18
	2.0	2.30	54.0	38.9	26.6	18.6	13.6	10.4	8.14	5.38	3.82	2.85	2.21	1.76	1.44
	2.6	2.95	68.9	49.3	33.5	23.4	17.1	13.0	10.2	6.75	4.79	3.57	2.77	2.21	1.80
	3.2	3.58	83.1	59.0	39.9	27.9	20.4	15.5	12.1	8.01	5.68	4.24	3.28	2.62	2.13
60.3	1.0	1.47	38.4	31.3	23.8	17.6	13.3	10.3	8.13	5.44	3.89	2.91	2.26	1.81	1.48
	1.6	2.33	60.7	49.2	37.2	27.5	20.7	16.0	12.6	8.46	6.04	4.53	3.52	2.81	2.30
	2.0	2.89	75.1	60.8	45.9	33.8	25.4	19.6	15.5	10.4	7.41	5.55	4.31	3.45	2.82
	2.6	3.72	96.3	77.7	58.3	42.9	32.2	24.8	19.6	13.1	9.36	7.01	5.45	4.35	3.56
	3.2	4.53	116	93.9	70.1	51.5	38.5	29.7	23.5	15.7	11.2	8.38	6.51	5.20	4.25
	4.0	5.59	143	114	85.0	62.2	46.5	35.8	28.3	18.9	13.5	10.1	7.83	6.25	5.11
5.0	6.86	175	138	102	74.5	55.5	42.7	33.7	22.5	16.0	12.0	9.31	7.44	6.08	
76.1	1.0	1.86	51.9	45.5	38.1	30.6	24.2	19.2	15.5	10.5	7.60	5.73	4.47	3.59	2.94
	1.6	2.96	82.4	72.0	60.1	48.1	37.9	30.1	24.2	16.5	11.9	8.96	6.99	5.61	4.60
	2.0	3.68	102	89.3	74.4	59.4	46.8	37.1	29.8	20.3	14.6	11.0	8.61	6.90	5.66
	2.6	4.74	131	114	95.3	75.9	59.6	47.2	38.0	25.8	18.6	14.0	10.9	8.77	7.19
	3.2	5.79	160	139	115	91.8	72.0	56.9	45.7	31.1	22.4	16.9	13.2	10.5	8.64
	4.0	7.16	197	171	141	112	87.7	69.2	55.6	37.7	27.2	20.5	16.0	12.8	10.5
5.0	8.82	242	210	172	135	105	83.5	67.0	45.4	32.7	24.6	19.2	15.4	12.6	
88.9	1.0	2.18	60.8	56.7	49.8	42.2	34.8	28.4	23.3	16.2	11.8	8.95	7.01	5.63	4.63
	1.6	3.47	96.5	89.9	78.8	66.6	54.8	44.7	36.6	25.4	18.5	14.0	11.0	8.84	7.26
	2.0	4.31	120	111	97.8	82.5	67.8	55.3	45.3	31.4	22.9	17.3	13.6	10.9	8.96
	2.6	5.57	155	143	125	105	86.8	70.7	57.8	40.1	29.2	22.1	17.3	13.9	11.4
	3.2	6.81	189	175	153	128	105	85.5	69.9	48.4	35.2	26.7	20.9	16.8	13.8
	4.0	8.43	234	216	188	157	128	104	85.4	59.1	42.9	32.5	25.4	20.4	16.8
5.0	10.4	289	266	231	192	156	127	103	71.6	52.0	39.4	30.8	24.7	20.3	
101.6	1.6	3.97	110	107	97.0	85.2	72.9	61.4	51.4	36.5	26.9	20.5	16.2	13.0	10.7
	2.0	4.94	137	133	120	105	90.5	76.0	63.6	45.2	33.3	25.4	20.0	16.1	13.2
	2.6	6.39	177	172	155	136	116	97.5	81.5	57.8	42.6	32.5	25.5	20.6	16.9
	3.2	7.81	217	210	189	165	141	118	98.8	70.1	51.5	39.3	30.9	24.9	20.5
	4.0	9.69	269	260	233	204	173	145	121	85.8	63.0	48.0	37.8	30.4	25.0
5.0	12.0	333	321	288	251	212	177	147	104	76.7	58.4	45.9	37.0	30.4	
114.3	1.6	4.48	124	124	114	103	91.6	79.3	68.0	49.7	37.1	28.6	22.6	18.3	15.1
	2.0	5.57	155	155	142	128	113	98.5	84.3	61.6	46.0	35.4	27.9	22.6	18.6
	2.6	7.21	200	200	184	166	146	126	108	79.0	58.9	45.3	35.8	28.9	23.9
	3.2	8.82	245	245	225	202	178	154	131	95.9	71.5	55.0	43.4	35.1	28.9
	4.0	10.9	304	303	278	250	220	189	161	117	87.7	67.4	53.2	43.0	35.5
5.0	13.6	377	375	343	308	270	232	198	143	107	82.2	64.9	52.4	43.2	

Only the sections which are non slender under axial compression are given in the table.

For explanation of table see Section 8.4.

COMPRESSION

CIRCULAR HOLLOW SECTIONS
SUBJECT TO AXIAL COMPRESSION

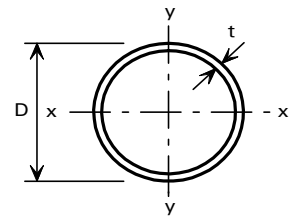

COMPRESSION RESISTANCE FOR GRADE 1.4401 (316) and 1.4404 (316L)

D mm	t mm	Mass per Metre kg	Compression Resistance P_c (kN)												
			for Effective Length L_e (m)												
			2.0	3.0	4.0	5.0	6.0	7.0	8.0	9.0	10.0	11.0	12.0	13.0	14.0
139.7	1.6	5.48	152	152	149	139	128	116	104	81.2	62.8	49.3	39.5	32.2	26.7
	2.0	6.84	186	159	129	100	78.0	61.2	48.9	39.9	33.1	27.9	23.8	20.5	17.9
	2.6	8.85	241	206	167	129	100	78.6	62.9	51.3	42.5	35.8	30.5	26.4	23.0
	3.2	10.8	295	252	203	158	122	95.7	76.5	62.3	51.7	43.5	37.1	32.0	27.9
	4.0	13.5	366	312	251	195	150	117	94.1	76.7	63.6	53.5	45.7	39.4	34.3
5.0	16.7	453	386	310	239	184	144	115	94.0	77.9	65.6	55.9	48.2	42.0	
168.3	2.0	8.25	229	210	181	151	122	99.2	80.8	66.6	55.7	47.2	40.4	35.0	30.6
	2.6	10.7	297	272	235	195	158	127	104	85.8	71.7	60.7	52.0	45.1	39.4
	3.2	13.1	365	333	287	238	193	155	126	104	87.4	74.0	63.4	54.9	48.0
	4.0	16.3	454	413	356	295	238	192	156	129	107	91.3	78.2	67.7	59.2
	5.0	20.3	564	513	441	364	294	237	192	158	132	112	96.1	83.2	72.7
219.1	2.6	14.0	389	385	352	316	276	237	201	170	145	125	108	94.5	83.1
	3.2	17.1	477	473	432	387	338	290	246	208	178	152	132	115	101
	4.0	21.4	594	588	537	481	420	359	305	258	220	189	163	142	125
	5.0	26.6	739	731	668	596	520	445	377	319	272	233	202	176	155
	273	3.2	21.4	596	596	581	540	495	447	398	350	307	269	236	209
4.0		26.7	743	743	724	672	616	556	494	435	381	334	294	259	230
5.0		33.3	926	926	901	836	766	690	614	540	473	414	364	321	284

Only the sections which are non slender under axial compression are given in the table.

For explanation of table see Section 8.4.

Table 40

COMPRESSION

**RECTANGULAR HOLLOW SECTIONS
SUBJECT TO AXIAL COMPRESSION**

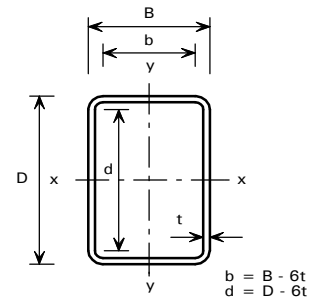

COMPRESSION RESISTANCE FOR GRADE 1.4401 (316) and 1.4404 (316L)

D x B mm	t mm	Mass per Metre kg	Axis	Compression Resistance, P_{cx} , P_{cy} (kN)												
				for Effective Length L_E (m)												
				1.0	1.5	2.0	2.5	3.0	3.5	4.0	5.0	6.0	7.0	8.0	9.0	10.0
50 x 25	1.5	1.63	P_{cx}	39.7	29.8	21.0	14.9	11.0	8.38	6.59	4.37	3.11	2.32	1.80	1.44	1.17
			P_{cy}	25.8	14.3	8.73	5.84	4.17	3.12	2.43	1.59	1.12	0.828	0.639	0.508	0.413
	2.0	2.11	P_{cx}	50.9	37.8	26.3	18.6	13.7	10.4	8.21	5.44	3.86	2.89	2.24	1.78	1.46
			P_{cy}	32.4	17.8	10.8	7.22	5.15	3.86	3.00	1.96	1.38	1.02	0.788	0.626	0.510
60 x 30	2.0	2.58	P_{cx}	67.5	55.0	41.8	31.0	23.4	18.0	14.3	9.57	6.84	5.13	3.98	3.18	2.60
			P_{cy}	49.3	29.8	18.7	12.7	9.12	6.86	5.34	3.50	2.47	1.84	1.42	1.13	0.920
	3.0	3.68	P_{cx}	94.8	76.2	57.0	41.8	31.3	24.1	19.1	12.7	9.10	6.81	5.29	4.23	3.46
			P_{cy}	67.4	39.8	24.8	16.7	12.0	9.03	7.03	4.61	3.25	2.41	1.86	1.48	1.21
80 x 40	* 2.0	3.53	P_{cx}	94.7	86.3	74.3	61.5	49.7	40.1	32.6	22.4	16.3	12.3	9.62	7.73	6.34
			P_{cy}	81.5	60.0	41.6	29.3	21.5	16.4	12.9	8.53	6.06	4.53	3.51	2.80	2.28
	3.0	5.10	P_{cx}	141	127	107	88.0	70.3	56.2	45.5	31.1	22.5	17.0	13.3	10.7	8.74
			P_{cy}	119	85.3	58.0	40.6	29.6	22.5	17.7	11.7	8.29	6.18	4.79	3.82	3.12
	4.0	6.54	P_{cx}	182	160	135	109	86.7	69.0	55.7	38.0	27.5	20.7	16.2	13.0	10.6
			P_{cy}	149	105	70.8	49.3	35.9	27.3	21.4	14.1	10.0	7.46	5.78	4.60	3.76
100 x 50	* 2.0	4.48	P_{cx}	108	107	98.5	88.4	77.4	66.6	56.6	41.1	30.6	23.4	18.5	15.0	12.3
			P_{cy}	104	87.2	68.5	52.0	39.7	30.9	24.6	16.5	11.8	8.89	6.92	5.53	4.53
	3.0	6.52	P_{cx}	181	176	158	139	119	100	84.0	59.7	43.9	33.5	26.4	21.3	17.5
			P_{cy}	169	137	103	76.2	57.2	44.1	34.9	23.4	16.7	12.5	9.71	7.76	6.34
	4.0	8.43	P_{cx}	234	226	203	177	151	126	105	74.5	54.8	41.8	32.8	26.4	21.8
			P_{cy}	217	173	129	95.0	71.1	54.7	43.3	28.9	20.6	15.4	12.0	9.58	7.83
	5.0	10.2	P_{cx}	284	272	243	211	178	148	123	87.0	63.8	48.6	38.2	30.7	25.3
			P_{cy}	260	206	151	110	82.5	63.4	50.1	33.4	23.8	17.8	13.8	11.0	9.03
	6.0	11.9	P_{cx}	330	314	279	241	202	167	138	97.1	71.1	54.0	42.4	34.1	28.1
			P_{cy}	299	234	170	123	91.6	70.3	55.4	36.9	26.3	19.7	15.3	12.2	9.96
150 x 75	* 3.0	10.1	P_{cx}	243	243	243	235	221	206	190	157	127	102	83.4	68.7	57.4
			P_{cy}	243	234	209	182	154	128	106	75.3	55.3	42.1	33.1	26.6	21.9
	* 4.0	13.2	P_{cx}	364	364	364	343	320	295	268	216	170	135	109	89.7	74.7
			P_{cy}	364	340	299	254	209	171	141	98.1	71.5	54.3	42.5	34.2	28.1
	5.0	16.1	P_{cx}	449	449	448	421	392	360	327	261	205	163	131	107	89.4
			P_{cy}	449	417	365	308	253	206	168	117	85.2	64.6	50.6	40.7	33.4
	6.0	19.0	P_{cx}	528	528	525	493	457	419	379	302	237	187	150	123	102
			P_{cy}	528	488	425	356	291	236	193	133	97.3	73.7	57.7	46.4	38.1
	8.0	24.2	P_{cx}	675	675	667	623	576	525	472	372	289	228	183	149	124
			P_{cy}	675	616	531	440	356	287	234	161	117	88.5	69.2	55.6	45.6
150 x 100	* 3.0	11.3	P_{cx}	276	276	276	270	255	238	221	185	151	122	100	82.8	69.3
			P_{cy}	276	276	263	242	218	194	169	127	96.9	75.2	59.8	48.5	40.1
	* 4.0	14.8	P_{cx}	408	408	408	390	366	339	311	254	203	163	132	108	90.5
			P_{cy}	408	408	379	344	306	267	230	169	127	98.2	77.7	62.9	51.9
	5.0	18.1	P_{cx}	504	504	504	480	449	416	380	309	246	197	159	130	109
			P_{cy}	504	504	466	422	374	325	279	204	153	118	93.4	75.6	62.4
	6.0	21.3	P_{cx}	594	594	594	563	527	487	444	360	285	227	184	150	125
			P_{cy}	594	594	547	494	436	378	323	236	176	136	107	87.0	71.7
	8.0	27.4	P_{cx}	763	763	763	718	669	616	560	449	354	281	226	185	154
			P_{cy}	763	759	695	624	548	471	401	291	217	166	131	106	87.7

* Section is slender under axial compression and allowance has been made in calculating the compression resistance.

For explanation of table see Section 8.4.

Table 40

COMPRESSION

**RECTANGULAR HOLLOW SECTIONS
SUBJECT TO AXIAL COMPRESSION**

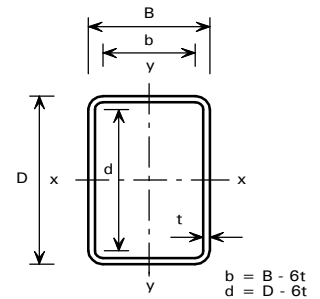

COMPRESSION RESISTANCE FOR GRADE 1.4401 (316) and 1.4404 (316L)

D x B mm	t mm	Mass per Metre kg	Axis	Compression Resistance, P_{cx} , P_{cy} (kN)												
				for Effective Length L_E (m)												
				1.0	1.5	2.0	2.5	3.0	3.5	4.0	5.0	6.0	7.0	8.0	9.0	10.0
200 x 100	* 4.0	17.9	P_{cx}	433	433	433	433	430	412	394	353	309	266	226	192	164
			P_{cy}	433	433	416	383	348	311	274	208	158	123	98.3	79.9	66.1
	* 5.0	22.1	P_{cx}	592	592	592	592	579	552	525	464	400	338	284	240	203
			P_{cy}	592	592	557	509	456	402	349	259	195	151	120	97.4	80.5
	6.0	26.1	P_{cx}	726	726	726	726	705	671	635	558	477	401	335	281	238
			P_{cy}	726	726	677	615	548	478	413	304	228	176	139	113	93.4
	8.0	33.7	P_{cx}	939	939	939	939	906	861	814	711	604	505	421	352	298
			P_{cy}	939	939	868	785	695	603	518	379	284	218	173	140	115
	10.0	40.8	P_{cx}	1140	1140	1140	1140	1090	1030	975	846	714	594	493	412	348
			P_{cy}	1140	1140	1040	937	824	711	607	442	329	253	200	161	133
200 x 125	* 4.0	19.5	P_{cx}	477	477	477	477	477	458	438	395	349	302	258	220	188
			P_{cy}	477	477	477	455	426	395	362	295	235	188	152	125	104
	* 5.0	24.0	P_{cx}	647	647	647	647	638	611	581	518	451	385	325	275	234
			P_{cy}	647	647	645	606	563	517	469	374	294	233	187	153	127
	6.0	28.5	P_{cx}	792	792	792	792	776	741	704	624	539	457	385	324	275
			P_{cy}	792	792	785	735	681	623	562	444	347	274	220	179	149
	8.0	36.9	P_{cx}	1030	1030	1030	1030	1000	955	906	799	687	580	486	409	347
			P_{cy}	1030	1030	1010	946	874	796	715	561	437	344	275	225	186
	10.0	44.8	P_{cx}	1250	1250	1250	1250	1210	1150	1090	957	818	687	575	482	408
			P_{cy}	1250	1250	1220	1140	1050	952	852	664	514	403	323	263	218
250 x 125	* 6.0	33.2	P_{cx}	874	874	874	874	874	872	842	778	709	634	560	490	427
			P_{cy}	874	874	874	826	770	711	648	522	413	329	265	217	181
	8.0	43.2	P_{cx}	1200	1200	1200	1200	1200	1190	1140	1050	949	841	735	638	553
			P_{cy}	1200	1200	1200	1120	1040	950	858	680	532	420	337	276	229
	10.0	52.7	P_{cx}	1470	1470	1470	1470	1470	1440	1390	1270	1140	1010	880	761	658
			P_{cy}	1470	1470	1450	1360	1250	1140	1030	809	631	497	398	325	270
	12.0	61.7	P_{cx}	1720	1720	1720	1720	1720	1680	1620	1480	1320	1160	1010	870	750
			P_{cy}	1720	1720	1690	1580	1450	1320	1180	923	716	562	450	367	305
	15.0	74.1	P_{cx}	2060	2060	2060	2060	2060	2010	1920	1750	1560	1360	1170	1010	864
			P_{cy}	2060	2060	2010	1870	1720	1550	1380	1070	820	642	513	417	346
250 x 150	* 6.0	35.6	P_{cx}	940	940	940	940	940	940	913	847	774	697	619	544	476
			P_{cy}	940	940	940	932	885	834	781	666	553	454	374	310	261
	8.0	46.4	P_{cx}	1290	1290	1290	1290	1290	1280	1240	1140	1040	926	815	711	619
			P_{cy}	1290	1290	1290	1270	1200	1130	1050	881	722	588	481	398	333
	10.0	56.6	P_{cx}	1580	1580	1580	1580	1580	1560	1510	1390	1260	1120	980	852	740
			P_{cy}	1580	1580	1580	1540	1460	1360	1270	1060	864	701	572	473	396
	12.0	66.4	P_{cx}	1850	1850	1850	1850	1850	1830	1760	1620	1460	1290	1130	979	848
			P_{cy}	1850	1850	1850	1800	1690	1580	1470	1220	991	801	653	538	450
	15.0	80.1	P_{cx}	2230	2230	2230	2230	2230	2190	2100	1920	1730	1520	1320	1140	986
			P_{cy}	2230	2230	2230	2150	2020	1880	1740	1430	1150	928	753	620	518

* Section is slender under axial compression and allowance has been made in calculating the compression resistance.

For explanation of table see Section 8.4.

Table 40

COMPRESSION

**RECTANGULAR HOLLOW SECTIONS
SUBJECT TO AXIAL COMPRESSION**

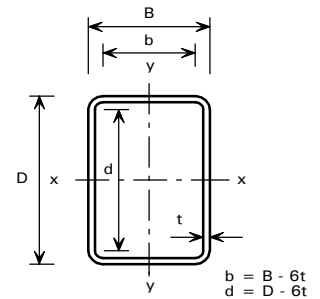

COMPRESSION RESISTANCE FOR GRADE 1.4401 (316) and 1.4404 (316L)

D x B mm	t mm	Mass per Metre kg	Axis	Compression Resistance, P_{cx} , P_{cy} (kN)												
				for Effective Length L_E (m)												
				2.0	3.0	4.0	5.0	6.0	7.0	8.0	9.0	10.0	11.0	12.0	13.0	14.0
300 x 150	* 6.0	40.3	P_{cx}	974	974	974	942	886	826	763	696	631	567	509	457	410
			P_{cy}	974	936	838	728	616	513	427	357	301	256	221	192	168
	* 8.0	52.7	P_{cx}	1460	1460	1460	1370	1280	1180	1070	967	864	768	683	608	543
			P_{cy}	1460	1360	1200	1020	839	687	564	467	392	333	286	248	217
	10.0	64.5	P_{cx}	1800	1800	1800	1690	1570	1440	1310	1170	1050	927	823	731	652
			P_{cy}	1800	1670	1460	1230	1010	824	675	558	468	397	340	295	258
	12.0	75.9	P_{cx}	2110	2110	2100	1970	1830	1680	1520	1360	1210	1070	948	841	749
			P_{cy}	2110	1950	1700	1430	1170	946	773	639	535	454	389	337	294
	15.0	91.9	P_{cx}	2560	2560	2530	2370	2190	2000	1810	1610	1420	1260	1110	984	876
			P_{cy}	2560	2340	2030	1690	1370	1100	899	742	620	525	450	390	340
300 x 200	* 6.0	45.0	P_{cx}	1110	1110	1110	1080	1020	955	886	814	742	671	605	545	491
			P_{cy}	1110	1110	1050	968	874	776	679	589	511	444	387	340	300
	* 8.0	59.0	P_{cx}	1630	1630	1630	1560	1460	1360	1250	1130	1020	911	814	728	652
			P_{cy}	1630	1630	1520	1380	1230	1070	921	790	679	586	509	445	392
	10.0	72.4	P_{cx}	2020	2020	2020	1920	1800	1670	1520	1380	1240	1110	986	880	788
			P_{cy}	2020	2020	1870	1690	1500	1300	1120	955	819	706	613	536	472
	12.0	85.4	P_{cx}	2380	2380	2380	2260	2110	1950	1780	1610	1440	1280	1140	1020	911
			P_{cy}	2380	2380	2190	1980	1750	1510	1300	1110	946	815	707	618	544
	15.0	103	P_{cx}	2890	2890	2890	2730	2540	2340	2130	1920	1710	1520	1350	1210	1080
			P_{cy}	2890	2880	2640	2370	2090	1800	1530	1310	1120	959	831	726	638
350 x 175	* 6.0	47.4	P_{cx}	1070	1070	1070	1070	1040	985	933	877	819	759	700	642	588
			P_{cy}	1070	1070	995	905	806	705	608	522	449	388	337	295	260
	* 8.0	62.2	P_{cx}	1600	1600	1600	1600	1520	1430	1350	1250	1160	1060	966	877	796
			P_{cy}	1600	1590	1450	1300	1130	971	824	699	596	512	443	386	339
	10.0	76.4	P_{cx}	2130	2130	2130	2090	1980	1870	1740	1610	1470	1340	1210	1090	987
			P_{cy}	2130	2080	1890	1670	1440	1210	1020	860	729	624	538	469	411
	12.0	90.1	P_{cx}	2510	2510	2510	2460	2330	2190	2040	1880	1720	1560	1410	1270	1150
			P_{cy}	2510	2440	2210	1950	1670	1410	1180	993	841	719	620	540	474
	15.0	109	P_{cx}	3050	3050	3050	2980	2820	2640	2450	2250	2050	1860	1670	1510	1360
			P_{cy}	3050	2960	2660	2330	1990	1670	1400	1170	989	845	728	633	555
350 x 200	* 6.0	49.8	P_{cx}	1130	1130	1130	1130	1100	1050	997	939	878	816	754	693	635
			P_{cy}	1130	1130	1100	1020	927	833	737	647	565	494	433	381	338
	* 8.0	65.3	P_{cx}	1690	1690	1690	1690	1610	1520	1430	1340	1240	1140	1040	947	862
			P_{cy}	1690	1690	1600	1460	1320	1160	1010	877	758	657	573	503	444
	10.0	80.3	P_{cx}	2240	2240	2240	2210	2100	1980	1850	1720	1580	1440	1310	1180	1070
			P_{cy}	2240	2240	2080	1890	1680	1470	1270	1090	934	807	701	613	540
	12.0	94.8	P_{cx}	2640	2640	2640	2610	2470	2330	2170	2010	1840	1680	1520	1380	1240
			P_{cy}	2640	2640	2450	2220	1970	1710	1470	1260	1080	934	811	709	625
	15.0	115	P_{cx}	3220	3220	3220	3160	2990	2810	2620	2420	2210	2010	1820	1640	1480
			P_{cy}	3220	3220	2960	2680	2360	2050	1750	1500	1280	1110	958	837	737

* Section is slender under axial compression and allowance has been made in calculating the compression resistance.

For explanation of table see Section 8.4.

Table 40

COMPRESSION

**RECTANGULAR HOLLOW SECTIONS
SUBJECT TO AXIAL COMPRESSION**

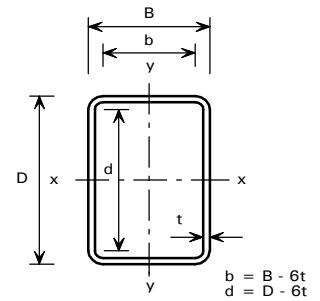

COMPRESSION RESISTANCE FOR GRADE 1.4401 (316) and 1.4404 (316L)

D x B mm	t mm	Mass per Metre kg	Axis	Compression Resistance, P_{cx} , P_{cy} (kN)												
				for Effective Length L_E (m)												
				2.0	3.0	4.0	5.0	6.0	7.0	8.0	9.0	10.0	11.0	12.0	13.0	14.0
400 x 200	* 6.0	54.5	P_{cx}	1150	1150	1150	1150	1150	1120	1080	1030	982	930	876	822	767
			P_{cy}	1150	1150	1130	1060	971	882	789	698	615	541	476	421	374
	* 8.0	71.6	P_{cx}	1730	1730	1730	1730	1720	1650	1580	1500	1410	1330	1240	1150	1060
			P_{cy}	1730	1730	1660	1540	1390	1250	1100	956	832	725	634	558	493
	* 10.0	88.2	P_{cx}	2370	2370	2370	2370	2320	2210	2100	1980	1860	1730	1600	1480	1360
			P_{cy}	2370	2370	2230	2040	1830	1610	1400	1200	1040	900	783	687	606
	12.0	104	P_{cx}	2910	2910	2910	2910	2820	2690	2540	2390	2230	2070	1910	1750	1610
			P_{cy}	2910	2910	2710	2460	2190	1920	1650	1420	1220	1050	915	801	706
	15.0	127	P_{cx}	3550	3550	3550	3550	3430	3260	3080	2900	2700	2500	2300	2100	1920
			P_{cy}	3550	3550	3290	2980	2640	2300	1970	1690	1450	1250	1090	949	835
400 x 250	* 6.0	59.3	P_{cx}	1240	1240	1240	1240	1240	1220	1170	1120	1070	1020	966	910	854
			P_{cy}	1240	1240	1240	1210	1140	1070	997	917	837	759	685	617	557
	* 8.0	78.0	P_{cx}	1910	1910	1910	1910	1910	1830	1750	1670	1580	1490	1400	1300	1210
			P_{cy}	1910	1910	1910	1820	1710	1580	1450	1310	1180	1060	942	841	753
	* 10.0	96.1	P_{cx}	2590	2590	2590	2590	2550	2440	2330	2200	2080	1940	1810	1670	1540
			P_{cy}	2590	2590	2580	2430	2260	2070	1880	1680	1500	1330	1180	1050	934
	12.0	113	P_{cx}	3170	3170	3170	3170	3110	2970	2820	2660	2500	2330	2160	1990	1830
			P_{cy}	3170	3170	3140	2940	2730	2490	2250	2010	1780	1570	1390	1230	1100
	15.0	139	P_{cx}	3880	3880	3880	3880	3790	3620	3430	3240	3030	2820	2610	2400	2200
			P_{cy}	3880	3880	3830	3580	3310	3020	2720	2420	2140	1880	1660	1470	1310

* Section is slender under axial compression and allowance has been made in calculating the compression resistance.

For explanation of table see Section 8.4.

Table 41

COMPRESSION

**SQUARE HOLLOW SECTIONS
SUBJECT TO AXIAL COMPRESSION**

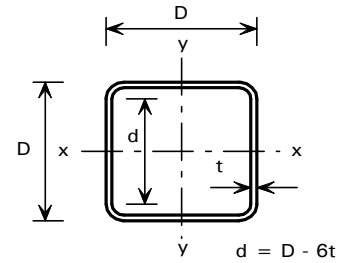

COMPRESSION RESISTANCE FOR GRADE 1.4401 (316) and 1.4404 (316L)

D x D mm	t mm	Mass per Metre kg	Compression Resistance P_c (kN)												
			for Effective Length L_e (m)												
			1.0	1.5	2.0	2.5	3.0	3.5	4.0	5.0	6.0	7.0	8.0	9.0	10.0
40 x 40	2.0	2.27	51.1	35.3	23.5	16.3	11.8	8.97	7.02	4.63	3.28	2.45	1.89	1.51	1.23
	3.0	3.20	70.4	47.4	31.1	21.5	15.6	11.8	9.22	6.07	4.30	3.20	2.48	1.97	1.61
50 x 50	2.0	2.90	73.5	57.8	42.3	30.7	22.9	17.5	13.8	9.23	6.58	4.92	3.82	3.05	2.49
	3.0	4.15	103	80.6	58.2	41.9	31.1	23.8	18.8	12.5	8.90	6.65	5.16	4.12	3.37
	4.0	5.27	130	99.3	70.7	50.6	37.4	28.6	22.5	14.9	10.6	7.94	6.16	4.92	4.01
60 x 60	2.0	3.53	95.4	80.8	64.4	49.5	38.0	29.7	23.7	16.0	11.4	8.60	6.69	5.36	4.38
	3.0	5.10	136	114	90.7	69.1	52.8	41.1	32.7	22.0	15.8	11.9	9.23	7.39	6.04
	4.0	6.54	173	144	113	85.4	65.0	50.4	40.1	26.9	19.3	14.5	11.3	9.01	7.37
	5.0	7.84	206	170	131	98.5	74.5	57.7	45.8	30.7	22.0	16.5	12.8	10.2	8.38
80 x 80	* 2.0	4.79	126	119	106	91.2	76.1	62.8	51.8	36.3	26.5	20.2	15.8	12.7	10.5
	3.0	6.99	194	181	159	135	111	90.9	74.6	51.8	37.7	28.6	22.4	18.0	14.8
	4.0	9.06	252	234	204	172	141	114	93.9	65.1	47.3	35.9	28.1	22.6	18.5
	5.0	11.0	306	282	245	204	167	135	110	76.4	55.5	42.0	32.9	26.4	21.7
100 x 100	3.0	8.89	247	247	226	204	179	154	132	96.3	71.8	55.2	43.6	35.2	29.1
	4.0	11.6	322	321	293	263	231	198	169	122	91.4	70.2	55.4	44.8	36.9
	5.0	14.2	394	390	357	319	278	239	202	146	108	83.5	65.9	53.2	43.9
	6.0	16.6	462	456	415	370	322	275	232	167	124	95.3	75.1	60.7	50.0
	8.0	21.1	587	574	520	460	397	336	282	202	149	114	89.9	72.5	59.7
125 x 125	* 3.0	11.3	288	288	286	268	249	228	206	164	128	101	81.7	66.8	55.5
	4.0	14.8	410	410	403	375	345	313	280	218	169	132	106	86.7	72.0
	5.0	18.1	504	504	493	459	421	381	340	264	204	160	128	104	86.6
	6.0	21.3	594	594	579	538	493	446	397	306	236	185	147	120	99.8
	8.0	27.4	763	763	739	684	625	561	497	381	292	228	181	148	122
150 x 150	* 3.0	13.6	305	305	305	305	291	276	260	224	188	156	129	108	91.2
	* 4.0	17.9	493	493	493	480	453	424	393	328	267	216	176	145	121
	5.0	22.1	614	614	614	595	561	524	484	402	326	263	214	176	147
	6.0	26.1	726	726	726	702	661	616	569	471	381	307	249	205	171
	8.0	33.7	939	939	939	903	848	789	726	597	479	385	312	257	214

* Section is slender under axial compression and allowance has been made in calculating the compression resistance.

For explanation of table see Section 8.4.

Table 41

COMPRESSION

**SQUARE HOLLOW SECTIONS
SUBJECT TO AXIAL COMPRESSION**

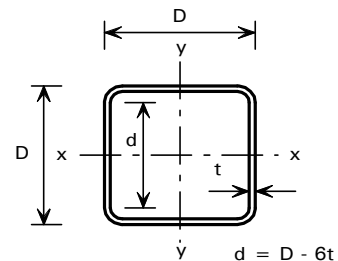

COMPRESSION RESISTANCE FOR GRADE 1.4401 (316) and 1.4404 (316L)

D x D mm	t mm	Mass per Metre kg	Compression Resistance P_c (kN)												
			for Effective Length L_e (m)												
			2.0	3.0	4.0	5.0	6.0	7.0	8.0	9.0	10.0	11.0	12.0	13.0	14.0
175 x 175	* 4.0	21.1	521	511	465	412	357	303	255	215	183	157	135	118	103
	5.0	26.0	724	698	626	546	464	388	323	270	228	194	167	146	128
	6.0	30.8	858	825	739	644	545	455	378	316	267	227	196	170	149
	8.0	40.0	1120	1070	953	826	696	578	480	400	337	287	247	215	188
	10.0	48.7	1360	1290	1150	991	831	688	569	474	399	340	292	253	222
200 x 200	* 4.0	24.2	543	543	518	477	431	383	335	292	253	220	192	169	149
	* 5.0	30.0	789	789	732	663	588	512	440	377	323	279	242	212	186
	6.0	35.6	990	988	906	816	718	619	529	450	385	331	287	250	220
	8.0	46.4	1290	1280	1180	1060	925	795	677	575	491	422	365	319	280
	10.0	56.6	1580	1560	1430	1280	1120	956	811	688	586	503	435	380	334
250 x 250	* 5.0	37.9	849	849	849	810	758	703	644	584	524	469	418	374	334
	* 6.0	45.0	1150	1150	1150	1080	998	914	826	739	656	581	514	456	406
	8.0	59.0	1640	1640	1610	1500	1380	1260	1120	993	874	769	677	598	531
	10.0	72.4	2020	2020	1970	1840	1690	1530	1360	1200	1060	929	817	722	640
	12.0	85.4	2380	2380	2320	2150	1980	1780	1590	1400	1230	1080	946	834	740
300 x 300	* 5.0	45.8	891	891	891	891	869	829	786	741	693	644	595	548	502
	* 6.0	54.5	1220	1220	1220	1220	1170	1110	1040	970	899	826	755	688	626
	* 8.0	71.6	1970	1970	1970	1920	1810	1700	1570	1440	1310	1190	1070	961	864
	10.0	88.2	2460	2460	2460	2380	2250	2100	1940	1780	1610	1450	1310	1170	1050
	12.0	104	2910	2910	2910	2810	2650	2470	2280	2080	1890	1700	1520	1370	1230
350 x 350	* 6.0	64.0	1280	1280	1280	1280	1280	1240	1190	1140	1080	1020	963	902	842
	* 8.0	84.3	2090	2090	2090	2090	2050	1960	1860	1760	1650	1540	1430	1320	1210
	10.0	104	2900	2900	2900	2900	2790	2650	2510	2350	2190	2020	1860	1700	1550
	12.0	123	3430	3430	3430	3430	3300	3140	2960	2770	2580	2380	2180	2000	1820
	15.0	151	4210	4210	4210	4210	4030	3830	3610	3370	3130	2880	2640	2410	2200
400 x 400	* 6.0	73.5	1320	1320	1320	1320	1320	1320	1300	1260	1210	1170	1120	1070	1020
	* 8.0	96.9	2170	2170	2170	2170	2170	2150	2070	1990	1910	1820	1730	1630	1530
	* 10.0	119	3160	3160	3160	3160	3160	3060	2930	2800	2650	2510	2360	2200	2050
	12.0	142	3960	3960	3960	3960	3950	3790	3630	3450	3260	3070	2870	2670	2480
	15.0	174	4870	4870	4870	4870	4850	4650	4440	4220	3990	3750	3500	3250	3010

* Section is slender under axial compression and allowance has been made in calculating the compression resistance.

For explanation of table see Section 8.4.

Table 42

COMPRESSION

CHANNELS
SUBJECT TO AXIAL COMPRESSION

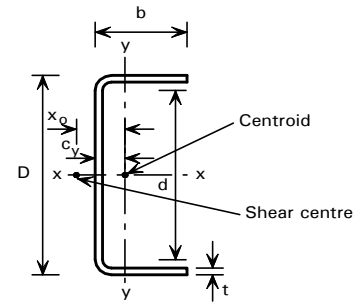

COMPRESSION RESISTANCE FOR GRADE 1.4401 (316) and 1.4404 (316L)

D x b mm	t mm	Mass per Metre kg	Axis	Compression Resistance, P _{cx} , P _{cxz} , P _{cy} (kN)													
				for Effective Length L _E (m)													
				1.0	1.5	2.0	2.5	3.0	3.5	4.0	5.0	6.0	7.0	8.0	9.0	10.0	
50 x 25	* 2.0	1.45	P _{cx}	36.5	28.8	21.1	15.3	11.4	8.76	6.92	4.61	3.29	2.46	1.91	1.52	1.25	
			P _{cxz}	21.9	18.1	15.0	12.2	9.81	7.91	6.45	4.46	3.23	2.44	1.91	1.53	1.25	
			P _{cy}	15.5	7.88	4.69	3.10	2.19	1.64	1.27	0.824	0.578	0.428	0.330	0.262	0.213	
	3.0	2.08	P _{cx}	52.0	40.3	29.1	21.0	15.6	11.9	9.39	6.25	4.45	3.33	2.58	2.06	1.68	
			P _{cxz}	40.4	33.6	26.1	19.7	15.1	11.8	9.36	6.30	4.50	3.37	2.62	2.09	1.71	
			P _{cy}	21.7	10.9	6.49	4.28	3.04	2.26	1.75	1.14	0.799	0.591	0.455	0.361	0.294	
75 x 35	3.0	3.14	P _{cx}	87.5	79.3	68.1	56.2	45.3	36.4	29.6	20.3	14.7	11.1	8.71	6.99	5.74	
			P _{cxz}	58.0	49.1	43.4	38.6	33.9	29.3	25.2	18.6	14.0	10.8	8.58	6.94	5.72	
			P _{cy}	52.7	29.8	18.3	12.3	8.80	6.60	5.13	3.35	2.36	1.75	1.35	1.08	0.876	
	4.0	4.06	P _{cx}	113	101	86.7	71.0	56.9	45.6	36.9	25.3	18.3	13.9	10.8	8.69	7.13	
			P _{cxz}	84.3	76.3	68.4	59.4	50.2	41.9	34.9	24.8	18.2	13.9	10.9	8.79	7.22	
			P _{cy}	67.0	37.7	23.2	15.5	11.1	8.32	6.47	4.23	2.98	2.21	1.71	1.36	1.10	
	5.0	4.91	P _{cx}	136	121	103	83.9	66.8	53.3	43.1	29.5	21.3	16.1	12.6	10.1	8.27	
			P _{cxz}	110	101	90.2	76.6	63.2	51.7	42.5	29.6	21.6	16.4	12.8	10.3	8.43	
			P _{cy}	79.8	44.7	27.4	18.3	13.1	9.81	7.62	4.98	3.51	2.60	2.01	1.60	1.30	
	100 x 50	* 3.0	4.45	P _{cx}	112	112	104	95.0	84.6	73.9	63.7	47.0	35.3	27.2	21.6	17.5	14.4
				P _{cxz}	82.5	64.6	53.2	46.2	41.5	37.9	35.0	29.9	25.5	21.5	18.1	15.4	13.1
				P _{cy}	95.1	68.9	47.3	33.2	24.3	18.5	14.5	9.60	6.81	5.09	3.94	3.14	2.56
* 4.0		5.80	P _{cx}	159	159	145	131	115	99.1	84.4	61.3	45.7	35.1	27.7	22.4	18.4	
			P _{cxz}	119	100	87.7	79.2	72.3	66.0	60.0	48.8	39.2	31.7	25.8	21.3	17.8	
			P _{cy}	131	92.5	62.1	43.3	31.5	23.9	18.7	12.4	8.78	6.55	5.07	4.04	3.30	
5.0		7.08	P _{cx}	197	195	178	159	139	119	101	73.3	54.5	41.8	32.9	26.6	21.9	
			P _{cxz}	153	136	125	114	104	94.2	83.8	65.2	50.7	40.0	32.1	26.2	21.8	
			P _{cy}	161	112	75.0	52.1	37.9	28.8	22.5	14.9	10.5	7.86	6.09	4.85	3.96	
125 x 50		* 3.0	5.04	P _{cx}	122	122	121	113	105	96.6	87.3	69.2	54.1	42.8	34.4	28.1	23.3
				P _{cxz}	95.5	76.0	61.8	52.8	47.1	43.1	40.2	35.8	32.3	29.0	25.8	22.7	19.9
				P _{cy}	103	74.6	51.0	35.8	26.2	19.9	15.6	10.3	7.33	5.47	4.24	3.38	2.76
	* 4.0	6.59	P _{cx}	181	181	177	164	150	135	120	93.3	71.8	56.1	44.8	36.5	30.3	
			P _{cxz}	140	116	100	90.8	83.8	78.4	73.7	64.8	55.8	47.4	39.9	33.7	28.6	
			P _{cy}	147	101	67.9	47.1	34.2	25.9	20.3	13.4	9.50	7.08	5.48	4.37	3.56	
	5.0	8.07	P _{cx}	224	224	217	201	184	165	146	112	86.4	67.4	53.8	43.8	36.3	
			P _{cxz}	178	157	143	133	125	118	110	93.1	76.6	62.6	51.3	42.5	35.7	
			P _{cy}	180	123	82.2	56.9	41.4	31.3	24.5	16.2	11.5	8.54	6.61	5.27	4.29	
	6.0	9.49	P _{cx}	264	264	255	235	214	192	170	130	99.5	77.5	61.8	50.2	41.6	
			P _{cxz}	216	198	187	177	167	156	143	117	93.9	75.2	60.9	50.1	41.7	
			P _{cy}	211	144	95.3	65.9	47.9	36.2	28.4	18.7	13.2	9.87	7.64	6.09	4.96	
150 x 60	* 4.0	8.01	P _{cx}	209	209	209	203	191	179	166	138	112	90.9	74.1	61.1	51.1	
			P _{cxz}	172	144	120	104	93.1	85.3	79.6	71.3	64.9	59.0	53.2	47.6	42.3	
			P _{cy}	188	147	106	77.1	57.3	43.9	34.6	23.0	16.4	12.3	9.53	7.61	6.21	
	5.0	9.85	P _{cx}	274	274	274	263	247	229	211	173	139	111	90.7	74.6	62.3	
			P _{cxz}	225	193	169	152	140	132	124	112	100	88.2	76.6	66.1	57.0	
			P _{cy}	243	186	132	95.1	70.3	53.7	42.3	28.1	20.0	14.9	11.6	9.25	7.56	
	6.0	11.6	P _{cx}	323	323	323	309	290	269	247	202	162	129	105	86.5	72.1	
			P _{cxz}	269	240	218	203	192	182	173	154	134	114	96.4	81.5	69.3	
			P _{cy}	286	218	155	110	81.9	62.6	49.3	32.7	23.3	17.4	13.5	10.8	8.80	
	8.0	15.0	P _{cx}	416	416	416	396	370	343	313	254	202	161	130	107	89.4	
			P _{cxz}	358	335	320	308	295	282	265	228	189	155	128	106	89.5	
			P _{cy}	366	277	195	139	102	78.6	61.8	41.1	29.2	21.8	16.9	13.5	11.0	

See Section 8.4.2 for guidance on calculating an effective length which allows for both the effects of end fixity and nominal end moments due to eccentricity of connection.

Slender sections must also be checked for the combined effects of the axial load and moment caused by the shift of neutral axis, see Section 8.4.2.

* Section is slender under axial compression and allowance has been made in calculating the compression resistance.

For explanation of table see Section 8.4

Table 42

COMPRESSION

**CHANNELS
SUBJECT TO AXIAL COMPRESSION**

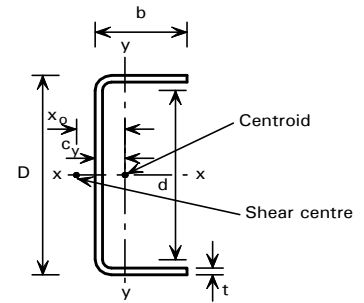

COMPRESSION RESISTANCE FOR GRADE 1.4401 (316) and 1.4404 (316L)

D x b mm	t mm	Mass per Metre kg	Axis	Compression Resistance, P_{cx} , P_{czz} , P_{cy} (kN)												
				for Effective Length L_E (m)												
				1.0	1.5	2.0	2.5	3.0	3.5	4.0	5.0	6.0	7.0	8.0	9.0	10.0
175 x 60	5.0	10.8	P_{cx}	301	301	301	300	285	270	253	217	182	150	123	103	86.8
			P_{czz}	252	215	185	165	150	140	133	122	113	104	94.9	85.0	75.5
			P_{cy}	265	200	141	100	74.2	56.7	44.6	29.6	21.0	15.7	12.2	9.73	7.94
	6.0	12.8	P_{cx}	356	356	356	354	336	318	298	255	212	175	144	120	100
			P_{czz}	300	265	238	220	207	197	189	174	159	143	125	109	94.6
			P_{cy}	312	235	165	117	86.7	66.2	52.0	34.5	24.6	18.3	14.2	11.3	9.26
	8.0	16.5	P_{cx}	460	460	460	455	432	407	380	324	268	219	180	150	125
			P_{czz}	397	368	349	336	325	315	304	276	242	206	174	147	125
			P_{cy}	401	299	209	148	109	83.4	65.6	43.5	30.9	23.1	17.9	14.3	11.7
	10.0	20.0	P_{cx}	557	557	557	548	519	488	455	384	316	258	211	175	146
			P_{czz}	492	471	458	447	436	421	403	357	304	254	211	177	149
			P_{cy}	482	357	248	175	129	98.5	77.4	51.3	36.5	27.2	21.1	16.8	13.7
200 x 75	* 5.0	13.0	P_{cx}	331	331	331	331	331	318	304	274	242	209	179	153	130
			P_{czz}	293	259	224	195	172	155	143	127	116	108	101	95.0	88.6
			P_{cy}	322	274	220	169	130	102	81.7	55.2	39.6	29.8	23.2	18.6	15.2
	* 6.0	15.4	P_{cx}	425	425	425	425	420	403	384	342	298	255	216	183	156
			P_{czz}	374	331	291	259	235	217	204	185	171	159	148	135	123
			P_{cy}	409	343	270	205	156	121	97.0	65.2	46.7	35.1	27.3	21.8	17.9
	8.0	20.0	P_{cx}	557	557	557	557	548	524	498	443	383	326	275	232	197
			P_{czz}	492	448	413	387	367	352	339	316	291	264	236	208	182
			P_{cy}	533	445	347	263	200	155	123	83.1	59.5	44.7	34.7	27.8	22.7
	10.0	24.4	P_{cx}	678	678	678	678	664	634	602	533	459	389	327	276	234
			P_{czz}	605	566	539	519	504	490	475	442	400	353	306	264	228
			P_{cy}	647	537	418	315	239	185	147	99.1	70.9	53.2	41.4	33.1	27.1
225 x 75	* 6.0	16.6	P_{cx}	455	455	455	455	455	445	427	390	349	306	265	228	197
			P_{czz}	404	358	314	277	249	229	213	193	179	169	159	150	141
			P_{cy}	436	363	284	214	163	126	100	67.8	48.5	36.4	28.3	22.7	18.5
	8.0	21.6	P_{cx}	601	601	601	601	601	584	560	509	453	395	341	292	251
			P_{czz}	534	485	444	412	389	371	358	336	317	297	274	249	223
			P_{cy}	572	474	367	276	209	162	129	86.6	62.0	46.5	36.2	28.9	23.6
	10.0	26.3	P_{cx}	733	733	733	733	733	709	679	615	545	474	407	349	299
			P_{czz}	657	611	578	554	537	523	510	485	454	415	371	328	287
			P_{cy}	695	574	442	331	250	194	154	103	74.0	55.5	43.2	34.5	28.2
	12.0	30.8	P_{cx}	858	858	858	858	858	825	790	713	630	545	467	398	341
			P_{czz}	776	736	711	694	680	667	653	618	569	510	448	390	338
			P_{cy}	811	666	511	381	288	223	177	118	84.9	63.7	49.5	39.6	32.4
250 x 100	* 6.0	20.2	P_{cx}	489	489	489	489	489	489	485	455	422	386	349	311	276
			P_{czz}	457	421	381	341	304	272	247	211	188	172	160	151	143
			P_{cy}	489	465	413	356	298	246	204	143	104	79.6	62.5	50.3	41.3
	* 8.0	26.3	P_{cx}	727	727	727	727	727	727	708	658	602	543	483	425	373
			P_{czz}	672	617	562	510	466	431	403	363	335	313	294	276	259
			P_{cy}	727	675	590	496	407	331	271	188	136	103	81.3	65.3	53.6
	10.0	32.3	P_{cx}	898	898	898	898	898	898	871	807	737	662	587	515	450
			P_{czz}	830	769	713	666	628	598	573	534	502	472	440	406	372
			P_{cy}	898	830	723	606	495	402	328	227	165	125	98.1	78.8	64.7
	12.0	37.9	P_{cx}	1060	1060	1060	1060	1060	1060	1020	943	859	770	681	596	520
			P_{czz}	977	915	864	825	794	769	748	710	670	625	575	522	470
			P_{cy}	1060	973	845	707	576	467	381	263	191	144	113	91.2	74.8

See Section 8.4.2 for guidance on calculating an effective length which allows for both the effects of end fixity and nominal end moments due to eccentricity of connection.

Slender sections must also be checked for the combined effects of the axial load and moment caused by the shift of neutral axis, see Section 8.4.2.

* Section is slender under axial compression and allowance has been made in calculating the compression resistance.

For explanation of table see Section 8.4

Table 42

COMPRESSION

**CHANNELS
SUBJECT TO AXIAL COMPRESSION**

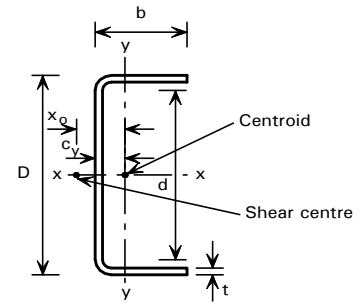

COMPRESSION RESISTANCE FOR GRADE 1.4401 (316) and 1.4404 (316L)

D x b mm	t mm	Mass per Metre kg	Axis	Compression Resistance, P_{cx} , P_{czz} , P_{cy} (kN)												
				for Effective Length L_E (m)												
				1.0	1.5	2.0	2.5	3.0	3.5	4.0	5.0	6.0	7.0	8.0	9.0	10.0
300 x 100	* 8.0	29.5	P_{cx}	810	810	810	810	810	810	810	776	728	675	620	563	507
			P_{czz}	757	699	638	578	524	479	443	392	359	336	319	305	292
			P_{cy}	810	745	646	539	439	355	290	200	145	110	86.3	69.3	56.9
	10.0	36.2	P_{cx}	1010	1010	1010	1010	1010	1010	1010	960	899	832	761	689	619
			P_{czz}	940	873	808	749	700	660	628	581	549	523	500	478	454
			P_{cy}	1010	922	796	661	536	433	352	243	176	133	104	83.9	68.8
	12.0	42.7	P_{cx}	1190	1190	1190	1190	1190	1190	1130	1050	974	889	803	720	
			P_{czz}	1110	1040	974	923	882	849	823	783	752	721	689	651	609
			P_{cy}	1190	1080	933	773	625	504	410	282	204	154	121	97.3	79.8
	15.0	51.9	P_{cx}	1440	1440	1440	1440	1440	1440	1360	1270	1170	1070	959	856	
			P_{czz}	1350	1280	1230	1190	1160	1140	1120	1080	1040	998	940	872	798
			P_{cy}	1440	1310	1130	928	748	601	488	336	243	184	143	115	94.8
350 x 125	* 8.0	35.8	P_{cx}	869	869	869	869	869	869	869	845	805	762	717	670	
			P_{czz}	840	794	744	691	636	583	534	457	402	363	336	315	299
			P_{cy}	869	869	804	727	644	560	480	352	263	203	160	130	107
	* 10.0	44.1	P_{cx}	1220	1220	1220	1220	1220	1220	1220	1160	1100	1030	960	888	
			P_{czz}	1170	1100	1030	953	881	815	758	670	610	567	535	509	488
			P_{cy}	1220	1200	1100	978	851	726	614	442	328	251	198	160	131
	12.0	52.2	P_{cx}	1450	1450	1450	1450	1450	1450	1450	1380	1300	1220	1130	1050	
			P_{czz}	1390	1310	1230	1160	1090	1020	972	892	835	793	758	728	699
			P_{cy}	1450	1430	1300	1160	1000	854	721	518	384	294	231	187	154
	15.0	63.7	P_{cx}	1770	1770	1770	1770	1770	1770	1760	1670	1580	1480	1370	1260	
			P_{czz}	1700	1610	1530	1460	1400	1350	1310	1240	1200	1150	1110	1070	1020
			P_{cy}	1770	1740	1580	1400	1220	1030	870	623	461	352	278	224	184
400 x 150	* 8.0	42.1	P_{cx}	915	915	915	915	915	915	915	915	901	867	831	794	
			P_{czz}	904	866	826	783	737	688	639	547	473	417	375	344	320
			P_{cy}	915	915	911	854	793	727	658	523	410	324	260	213	177
	* 10.0	52.0	P_{cx}	1330	1330	1330	1330	1330	1330	1330	1330	1330	1270	1220	1160	1100
			P_{czz}	1300	1240	1180	1110	1040	966	898	780	690	623	574	537	508
			P_{cy}	1330	1330	1290	1200	1100	990	881	679	523	409	326	266	220
	* 12.0	61.6	P_{cx}	1700	1700	1700	1700	1700	1700	1700	1680	1610	1540	1460	1370	
			P_{czz}	1660	1580	1500	1410	1330	1240	1160	1040	941	871	818	777	743
			P_{cy}	1700	1700	1640	1510	1370	1230	1080	820	626	487	387	315	260
	15.0	75.6	P_{cx}	2100	2100	2100	2100	2100	2100	2100	2100	2070	1980	1890	1780	1680
			P_{czz}	2050	1950	1860	1760	1680	1600	1530	1420	1340	1270	1220	1170	1130
			P_{cy}	2100	2100	2020	1860	1680	1500	1320	996	758	589	469	381	315

See Section 8.4.2 for guidance on calculating an effective length which allows for both the effects of end fixity and nominal end moments due to eccentricity of connection.

Slender sections must also be checked for the combined effects of the axial load and moment caused by the shift of neutral axis, see Section 8.4.2.

* Section is slender under axial compression and allowance has been made in calculating the compression resistance.

For explanation of table see Section 8.4

Table 43

COMPRESSION

**DOUBLE CHANNELS BACK TO BACK
SUBJECT TO AXIAL COMPRESSION**

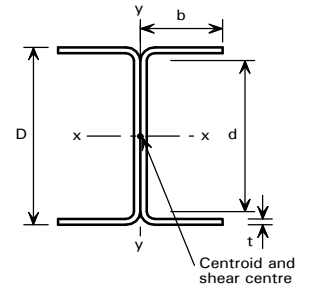

COMPRESSION RESISTANCE FOR GRADE 1.4401 (316) and 1.4404 (316L)

D x 2b mm	t mm	Mass per Metre kg	Axis	Compression Resistance, P_{cx} , P_{cy} , P_{cz} (kN)												
				for Effective Length L_E (m)												
				1.0	1.5	2.0	2.5	3.0	3.5	4.0	5.0	6.0	7.0	8.0	9.0	10.0
50 x 50	* 2.0	2.90	P_{cx}	58.9	45.0	33.7	25.3	19.4	15.3	12.3	8.37	6.06	4.59	3.59	2.89	2.37
			P_{cy}	37.7	22.5	14.5	9.97	7.26	5.51	4.33	2.87	2.04	1.52	1.18	0.941	0.768
			P_{cz}	60.1	54.3	51.3	49.7	48.7	48.1	47.7	47.2	47.0	46.8	46.7	46.6	46.6
	3.0	4.15	P_{cx}	85.0	63.9	47.1	35.1	26.7	20.9	16.8	11.4	8.25	6.24	4.88	3.92	3.22
			P_{cy}	56.3	33.9	21.8	15.0	10.9	8.32	6.53	4.33	3.08	2.30	1.78	1.42	1.16
			P_{cz}	97.9	95.2	94.1	93.5	93.2	93.0	92.9	92.7	92.6	92.6	92.6	92.5	92.5
75 x 70	* 3.0	6.28	P_{cx}	151	129	107	88.8	72.7	59.8	49.6	35.3	26.2	20.2	16.0	12.9	10.7
			P_{cy}	110	75.1	51.6	36.9	27.4	21.1	16.7	11.2	8.05	6.05	4.71	3.77	3.09
			P_{cz}	144	131	122	116	113	111	109	107	106	106	105	105	105
	4.0	8.12	P_{cx}	196	166	137	112	92.0	75.4	62.4	44.2	32.7	25.1	19.9	16.1	13.3
			P_{cy}	144	99.6	68.7	49.2	36.6	28.2	22.4	15.0	10.8	8.10	6.31	5.05	4.14
			P_{cz}	195	185	180	178	176	175	174	173	173	172	172	172	172
	5.0	9.82	P_{cx}	235	198	163	133	108	88.5	73.1	51.6	38.2	29.3	23.1	18.7	15.5
			P_{cy}	177	123	85.5	61.4	45.8	35.4	28.1	18.9	13.5	10.2	7.93	6.35	5.20
			P_{cz}	244	238	235	233	233	232	232	231	231	231	231	231	231
100 x 100	* 3.0	8.89	P_{cx}	211	190	170	151	133	116	101	77.0	59.6	47.1	37.9	31.2	26.0
			P_{cy}	176	140	109	84.8	66.3	52.8	42.8	29.6	21.6	16.4	12.9	10.4	8.54
			P_{cz}	199	180	162	147	135	127	120	112	107	103	101	100	99.1
	* 4.0	11.6	P_{cx}	296	265	235	207	180	155	134	101	77.7	61.0	49.0	40.2	33.5
			P_{cy}	246	195	150	115	90.2	71.6	57.9	39.9	29.0	22.0	17.3	13.9	11.5
			P_{cz}	281	258	240	226	217	210	205	198	194	192	190	189	188
	5.0	14.2	P_{cx}	370	330	292	255	221	190	163	122	93.4	73.2	58.7	48.1	40.0
			P_{cy}	310	245	189	145	113	89.9	72.7	50.1	36.4	27.7	21.7	17.5	14.4
			P_{cz}	355	333	318	308	302	297	294	290	288	287	286	285	284
125 x 100	* 3.0	10.1	P_{cx}	240	221	203	185	169	152	137	109	88.2	71.4	58.6	48.8	41.1
			P_{cy}	188	148	114	87.6	68.0	53.9	43.6	30.0	21.8	16.5	13.0	10.5	8.60
			P_{cz}	218	197	175	156	140	129	120	108	101	97.1	94.1	92.1	90.6
	* 4.0	13.2	P_{cx}	351	321	293	265	238	213	189	149	118	94.9	77.3	64.0	53.8
			P_{cy}	273	211	160	121	93.5	73.7	59.4	40.7	29.5	22.4	17.5	14.1	11.6
			P_{cz}	320	290	264	243	228	217	208	198	191	187	185	183	181
	5.0	16.1	P_{cx}	440	402	365	329	295	262	232	182	143	114	93.4	77.2	64.8
			P_{cy}	344	266	201	152	117	92.6	74.6	51.1	37.1	28.1	22.0	17.7	14.5
			P_{cz}	404	373	350	333	321	313	307	300	295	292	290	289	288
	6.0	19.0	P_{cx}	516	470	427	384	344	305	270	210	165	132	107	88.8	74.4
			P_{cy}	407	316	240	182	140	111	89.6	61.4	44.6	33.8	26.5	21.3	17.5
			P_{cz}	478	450	432	420	412	407	403	398	396	394	393	392	391
150 x 120	* 4.0	16.0	P_{cx}	411	390	363	337	311	286	262	217	179	148	123	103	88.3
			P_{cy}	342	282	226	179	143	115	94.5	66.0	48.4	37.0	29.1	23.5	19.4
			P_{cz}	382	352	321	292	267	247	231	209	196	187	181	177	174
	* 5.0	19.7	P_{cx}	539	507	470	434	399	365	333	273	223	183	152	127	108
			P_{cy}	445	364	290	229	182	146	119	83.3	61.1	46.6	36.7	29.6	24.4
			P_{cz}	498	461	426	397	373	354	340	321	309	301	296	293	290
	6.0	23.2	P_{cx}	647	606	561	517	474	433	393	322	262	214	177	148	125
			P_{cy}	535	437	349	276	219	176	144	100	73.5	56.1	44.2	35.7	29.4
			P_{cz}	598	558	525	499	480	465	454	440	432	426	422	420	418
	8.0	29.9	P_{cx}	833	776	717	660	604	550	498	405	328	268	221	185	156
			P_{cy}	694	572	459	365	291	234	192	134	98.5	75.2	59.2	47.8	39.4
			P_{cz}	775	738	713	697	687	679	674	667	664	661	660	659	658

* Section is slender under axial compression and allowance has been made in calculating the compression resistance.

For explanation of table see Section 8.4.

DOUBLE CHANNELS BACK TO BACK SUBJECT TO AXIAL COMPRESSION

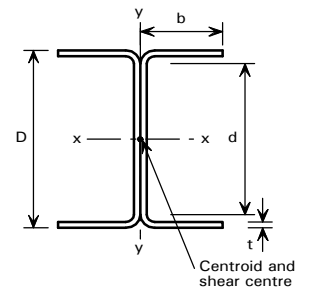

COMPRESSION RESISTANCE FOR GRADE 1.4401 (316) and 1.4404 (316L)

D x 2b mm	t mm	Mass per Metre kg	Axis	Compression Resistance, P_{cx} , P_{cy} , P_{cz} (kN)												
				for Effective Length L_E (m)												
				1.0	1.5	2.0	2.5	3.0	3.5	4.0	5.0	6.0	7.0	8.0	9.0	10.0
175 x 120	* 5.0	21.7	P_{cx}	594	575	539	504	470	436	404	342	287	241	203	172	147
			P_{cy}	482	389	306	239	188	150	122	84.8	61.9	47.2	37.1	29.9	24.6
			P_{cz}	548	505	462	423	391	366	347	320	304	294	287	282	278
	6.0	25.6	P_{cx}	713	687	643	601	559	519	479	404	339	283	238	202	172
			P_{cy}	578	467	368	287	226	181	147	102	74.6	56.8	44.7	36.0	29.7
			P_{cz}	658	610	567	532	504	483	468	446	433	425	419	415	413
	8.0	33.1	P_{cx}	921	885	827	771	717	663	611	513	428	357	299	253	216
			P_{cy}	754	613	485	381	301	241	196	136	100	76.3	60.0	48.4	39.9
			P_{cz}	853	806	772	748	732	720	711	701	694	690	687	686	684
	10.0	40.1	P_{cx}	1120	1070	995	926	859	793	729	609	506	421	352	297	253
			P_{cy}	921	753	601	475	376	302	247	172	126	96.3	75.8	61.2	50.4
			P_{cz}	1040	1000	976	961	951	945	941	935	932	930	929	928	928
200 x 150	* 5.0	26.0	P_{cx}	652	652	619	587	556	525	495	436	380	330	286	248	215
			P_{cy}	582	502	426	356	296	246	206	148	110	85.4	67.8	55.1	45.6
			P_{cz}	625	588	550	510	472	437	407	361	330	309	295	284	276
	* 6.0	30.8	P_{cx}	836	831	786	743	701	660	619	541	468	403	346	299	259
			P_{cy}	739	634	534	444	366	303	252	180	134	103	82.2	66.7	55.2
			P_{cz}	797	749	701	655	612	576	545	500	470	450	436	426	419
	8.0	40.0	P_{cx}	1120	1100	1040	983	925	869	813	707	608	521	446	383	331
			P_{cy}	987	847	714	594	490	406	338	242	180	139	110	89.5	74.0
			P_{cz}	1060	1000	951	908	873	845	823	793	773	760	751	745	741
	10.0	48.7	P_{cx}	1360	1340	1260	1190	1120	1050	981	849	728	622	531	456	393
			P_{cy}	1210	1040	881	735	609	505	422	303	226	174	138	112	93.0
			P_{cz}	1290	1230	1190	1150	1130	1110	1100	1080	1070	1060	1060	1050	1050
225 x 150	* 6.0	33.2	P_{cx}	896	896	862	820	779	739	699	622	549	481	420	367	321
			P_{cy}	784	668	559	460	377	310	257	183	136	104	83.0	67.3	55.6
			P_{cz}	854	802	747	693	643	598	561	505	469	444	427	415	406
	8.0	43.2	P_{cx}	1200	1200	1150	1090	1040	980	926	820	719	627	545	474	414
			P_{cy}	1050	897	750	618	506	417	346	246	182	140	111	90.3	74.7
			P_{cz}	1140	1080	1020	963	918	882	853	811	785	767	755	746	740
	10.0	52.7	P_{cx}	1470	1470	1400	1330	1260	1190	1120	990	866	753	653	567	494
			P_{cy}	1290	1100	927	767	631	520	432	308	229	176	140	113	94.0
			P_{cz}	1400	1330	1270	1220	1190	1170	1150	1120	1110	1100	1090	1080	1080
	12.0	61.7	P_{cx}	1720	1720	1630	1550	1460	1380	1300	1150	999	866	750	650	565
			P_{cy}	1520	1300	1100	913	754	624	520	372	277	213	169	137	113
			P_{cz}	1630	1570	1520	1480	1460	1450	1430	1420	1410	1400	1400	1400	1400
250 x 200	* 6.0	40.3	P_{cx}	963	963	960	922	885	849	813	743	676	610	548	491	439
			P_{cy}	929	840	755	673	595	522	457	350	272	215	174	143	119
			P_{cz}	953	914	874	832	789	746	703	625	563	516	480	454	434
	* 8.0	52.7	P_{cx}	1430	1430	1410	1350	1290	1230	1170	1060	955	853	759	673	597
			P_{cy}	1360	1230	1090	967	847	737	640	485	373	294	237	194	162
			P_{cz}	1400	1340	1280	1220	1160	1110	1060	975	913	868	835	811	792
	10.0	64.5	P_{cx}	1800	1800	1760	1680	1610	1530	1460	1320	1180	1050	931	823	728
			P_{cy}	1710	1540	1380	1220	1070	927	804	609	469	370	298	244	204
			P_{cz}	1760	1690	1620	1550	1490	1440	1400	1330	1290	1250	1230	1210	1200
	12.0	75.9	P_{cx}	2110	2110	2070	1970	1880	1800	1710	1540	1380	1220	1080	954	842
			P_{cy}	2020	1820	1630	1440	1270	1100	960	729	563	444	358	294	245
			P_{cz}	2070	1980	1910	1850	1800	1760	1730	1680	1650	1630	1610	1600	1590

* Section is slender under axial compression and allowance has been made in calculating the compression resistance.

For explanation of table see Section 8.4.

DOUBLE CHANNELS BACK TO BACK SUBJECT TO AXIAL COMPRESSION

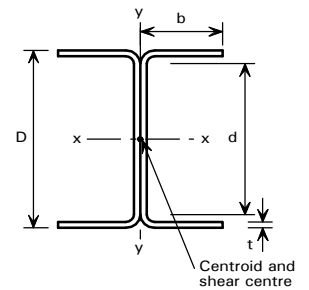

COMPRESSION RESISTANCE FOR GRADE 1.4401 (316) and 1.4404 (316L)

D x 2b mm	t mm	Mass per Metre kg	Axis	Compression Resistance, P_{cx} , P_{cy} , P_{cz} (kN)												
				for Effective Length L_E (m)												
				1.0	1.5	2.0	2.5	3.0	3.5	4.0	5.0	6.0	7.0	8.0	9.0	10.0
300 x 200	* 8.0	59.0	P_{cx}	1590	1590	1590	1550	1500	1440	1390	1280	1180	1070	976	885	800
			P_{cy}	1500	1340	1190	1040	903	779	671	502	384	301	242	198	165
			P_{cz}	1570	1500	1430	1350	1280	1210	1140	1030	943	880	833	799	773
	10.0	72.4	P_{cx}	2020	2020	2020	1960	1880	1810	1740	1600	1470	1340	1210	1090	985
			P_{cy}	1900	1700	1500	1310	1140	982	846	632	484	379	304	249	207
			P_{cz}	1980	1890	1800	1720	1650	1580	1510	1410	1340	1290	1250	1220	1200
	12.0	85.4	P_{cx}	2380	2380	2380	2300	2210	2130	2040	1880	1720	1560	1410	1270	1150
			P_{cy}	2250	2010	1780	1560	1360	1170	1010	758	581	456	366	300	250
			P_{cz}	2330	2230	2140	2060	1990	1930	1880	1800	1750	1710	1680	1670	1650
	15.0	103	P_{cx}	2890	2890	2890	2780	2680	2570	2470	2260	2060	1870	1690	1520	1370
			P_{cy}	2740	2460	2190	1930	1680	1460	1260	948	728	573	460	377	315
			P_{cz}	2820	2710	2630	2550	2500	2450	2420	2370	2340	2320	2310	2300	2290
350 x 250	* 8.0	71.6	P_{cx}	1710	1710	1710	1710	1680	1630	1590	1490	1400	1310	1230	1140	1060
			P_{cy}	1710	1580	1450	1320	1200	1090	978	784	630	510	419	348	294
			P_{cz}	1710	1670	1610	1550	1490	1430	1370	1240	1130	1030	954	891	842
	* 10.0	88.2	P_{cx}	2400	2400	2400	2400	2320	2250	2180	2040	1900	1770	1640	1520	1390
			P_{cy}	2370	2170	1990	1810	1630	1460	1300	1030	820	659	538	446	375
			P_{cz}	2390	2310	2230	2150	2060	1980	1890	1740	1610	1500	1420	1360	1310
	12.0	104	P_{cx}	2910	2910	2910	2900	2810	2720	2630	2460	2290	2120	1960	1810	1660
			P_{cy}	2870	2630	2410	2180	1970	1770	1580	1250	990	796	650	539	453
			P_{cz}	2900	2800	2700	2600	2510	2420	2340	2190	2070	1980	1910	1860	1820
	15.0	127	P_{cx}	3550	3550	3550	3530	3420	3310	3200	2980	2780	2570	2370	2180	2000
			P_{cy}	3510	3230	2960	2690	2430	2180	1950	1550	1230	994	813	674	567
			P_{cz}	3530	3410	3300	3200	3110	3030	2960	2840	2760	2700	2650	2620	2590
400 x 300	* 8.0	84.3	P_{cx}	1810	1810	1810	1810	1810	1790	1750	1660	1580	1500	1430	1350	1280
			P_{cy}	1810	1750	1640	1540	1440	1340	1240	1050	886	745	629	534	457
			P_{cz}	1810	1800	1750	1700	1660	1610	1560	1450	1340	1230	1130	1040	970
	* 10.0	104	P_{cx}	2610	2610	2610	2610	2610	2550	2480	2350	2230	2100	1980	1860	1750
			P_{cy}	2610	2500	2330	2170	2010	1860	1710	1430	1190	985	824	695	592
			P_{cz}	2610	2570	2500	2430	2360	2280	2200	2040	1890	1750	1630	1530	1450
	* 12.0	123	P_{cx}	3350	3350	3350	3350	3320	3230	3150	2970	2810	2640	2480	2320	2170
			P_{cy}	3350	3180	2960	2750	2540	2340	2140	1780	1470	1210	1010	850	722
			P_{cz}	3350	3290	3190	3090	3000	2900	2810	2620	2450	2300	2180	2080	2000
	15.0	151	P_{cx}	4210	4210	4210	4210	4170	4050	3940	3720	3500	3290	3080	2880	2680
			P_{cy}	4210	4000	3720	3460	3190	2940	2690	2230	1840	1520	1270	1070	908
			P_{cz}	4210	4120	4000	3890	3780	3670	3570	3390	3240	3120	3020	2940	2880

* Section is slender under axial compression and allowance has been made in calculating the compression resistance.
For explanation of table see Section 8.4.

Table 44

COMPRESSION

**EQUAL ANGLES
SUBJECT TO AXIAL COMPRESSION**

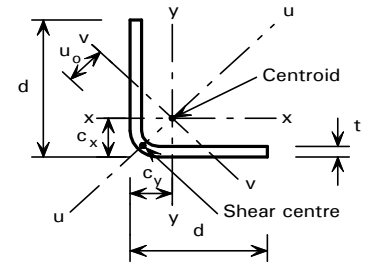

COMPRESSION RESISTANCE FOR GRADE 1.4401 (316) and 1.4404 (316L)

d x d mm	t mm	Mass per Metre kg	Axis	Compression Resistance, P_{cx} , P_{cy} , P_{ouz} , P_{cv} (kN)												
				for Effective Length L_E (m)												
				1.0	1.5	2.0	2.5	3.0	3.5	4.0	5.0	6.0	7.0	8.0	9.0	10.0
50 x 50	* 5.0	3.54	P_{cx}, P_{cy}	77.8	55.0	37.1	25.9	18.9	14.3	11.2	7.42	5.26	3.92	3.04	2.42	1.98
			P_{ouz}	76.6	65.4	51.3	38.9	29.6	23.0	18.2	12.2	8.72	6.52	5.06	4.04	3.30
			P_{cv}	45.7	24.2	14.6	9.68	6.88	5.15	3.99	2.60	1.83	1.36	1.05	0.830	0.675
	6.0	4.15	P_{cx}, P_{cy}	93.9	65.0	43.3	30.1	21.9	16.6	13.0	8.57	6.07	4.53	3.50	2.79	2.28
			P_{ouz}	96.3	80.8	62.3	46.5	35.1	27.1	21.5	14.3	10.2	7.62	5.90	4.71	3.84
			P_{cv}	51.7	26.9	16.1	10.7	7.58	5.66	4.39	2.86	2.01	1.49	1.15	0.910	0.740
	8.0	5.27	P_{cx}, P_{cy}	117	80.5	53.3	36.9	26.8	20.3	15.9	10.5	7.42	5.53	4.28	3.41	2.78
			P_{ouz}	125	104	79.7	59.1	44.3	34.1	26.9	17.9	12.7	9.51	7.37	5.87	4.79
			P_{cv}	58.6	29.8	17.8	11.7	8.32	6.21	4.81	3.13	2.19	1.63	1.25	0.994	0.808
	10.0	6.26	P_{cx}, P_{cy}	137	93.0	61.2	42.2	30.6	23.2	18.1	12.0	8.46	6.30	4.88	3.89	3.17
			P_{ouz}	149	123	94.1	69.4	51.9	39.8	31.4	20.9	14.8	11.1	8.56	6.83	5.57
			P_{cv}	60.8	30.4	18.0	11.9	8.40	6.26	4.84	3.14	2.21	1.63	1.26	0.997	0.811
75 x 75	* 6.0	6.52	P_{cx}, P_{cy}	147	128	106	84.8	66.6	52.7	42.3	28.8	20.7	15.6	12.2	9.77	8.01
			P_{ouz}	122	118	109	98.6	85.7	72.9	61.6	44.3	32.9	25.1	19.8	15.9	13.1
			P_{cv}	120	83.1	55.4	38.4	28.0	21.2	16.6	10.9	7.76	5.78	4.48	3.57	2.91
	* 8.0	8.43	P_{cx}, P_{cy}	225	190	151	115	88.8	69.2	55.2	37.2	26.7	20.0	15.6	12.5	10.2
			P_{ouz}	202	191	172	149	125	103	85.4	59.8	43.6	33.1	25.9	20.8	17.0
			P_{cv}	171	108	69.3	47.3	34.1	25.7	20.1	13.2	9.32	6.93	5.36	4.27	3.48
	10.0	10.2	P_{cx}, P_{cy}	273	230	181	138	105	82.2	65.4	44.0	31.6	23.7	18.4	14.8	12.1
			P_{ouz}	256	239	214	184	154	126	104	72.4	52.6	39.8	31.1	25.0	20.5
			P_{cv}	199	122	77.6	52.6	37.9	28.5	22.2	14.6	10.3	7.66	5.92	4.71	3.84
	12.0	11.9	P_{cx}, P_{cy}	316	265	207	157	119	93.3	74.2	49.9	35.8	26.8	20.9	16.7	13.7
			P_{ouz}	304	281	251	216	179	146	120	83.5	60.6	45.8	35.8	28.7	23.5
			P_{cv}	221	131	82.4	55.6	39.9	30.0	23.4	15.3	10.8	8.04	6.21	4.94	4.02
100 x 100	* 8.0	11.6	P_{cx}, P_{cy}	263	254	228	199	169	141	118	83.8	61.6	46.9	36.9	29.7	24.5
			P_{ouz}	220	216	209	199	185	169	152	119	92.7	72.9	58.4	47.6	39.5
			P_{cv}	244	197	147	108	81.5	62.8	49.7	33.2	23.7	17.8	13.8	11.0	9.01
	* 10.0	14.2	P_{cx}, P_{cy}	375	352	311	265	219	180	148	103	75.5	57.3	44.9	36.1	29.7
			P_{ouz}	328	320	306	286	261	233	205	155	118	91.8	72.9	59.2	48.9
			P_{cv}	333	255	182	130	96.7	73.9	58.2	38.7	27.5	20.6	16.0	12.7	10.4
	12.0	16.6	P_{cx}, P_{cy}	462	429	375	316	259	211	173	120	87.5	66.3	51.9	41.7	34.3
			P_{ouz}	418	406	385	357	323	286	249	186	140	108	85.8	69.4	57.3
			P_{cv}	400	296	206	146	107	81.9	64.4	42.7	30.3	22.6	17.6	14.0	11.4
	15.0	20.0	P_{cx}, P_{cy}	557	515	448	376	307	249	204	141	102	77.8	60.9	48.9	40.2
			P_{ouz}	522	502	473	437	394	348	302	224	168	129	102	83.0	68.3
			P_{cv}	468	336	229	160	117	89.2	70.0	46.3	32.8	24.5	19.0	15.1	12.3
120 x 120	* 8.0	14.1	P_{cx}, P_{cy}	281	281	268	247	224	199	174	132	100	78.0	62.0	50.4	41.7
			P_{ouz}	226	223	220	214	207	198	187	161	134	111	92.2	76.8	64.7
			P_{cv}	281	247	207	166	131	104	84.3	57.5	41.5	31.3	24.4	19.6	16.0
	* 10.0	17.3	P_{cx}, P_{cy}	405	405	376	341	303	264	227	167	125	96.7	76.5	62.0	51.1
			P_{ouz}	344	339	332	322	307	289	268	223	180	145	118	97.8	81.8
			P_{cv}	395	337	271	210	162	127	101	68.6	49.3	37.0	28.9	23.1	18.9
	* 12.0	20.4	P_{cx}, P_{cy}	540	535	488	437	381	326	277	200	148	114	90.1	72.8	60.0
			P_{ouz}	475	468	455	437	412	383	350	282	223	178	143	117	97.7
			P_{cv}	514	426	330	248	188	146	116	77.9	55.7	41.8	32.5	26.0	21.3
	15.0	24.8	P_{cx}, P_{cy}	689	676	614	544	471	399	336	241	178	136	107	86.8	71.5
			P_{ouz}	633	620	599	570	534	492	446	354	277	219	175	143	118
			P_{cv}	641	517	388	286	214	165	131	87.6	62.6	46.9	36.4	29.1	23.8

See Section 8.4.2 for guidance on calculating an effective length which allows for both the effects of end fixity and nominal end moments due to eccentricity of connection.

Slender sections must also be checked for the combined effects of the axial load and moment caused by the shift of neutral axis, see Section 8.4.2

* Section is slender under axial compression and allowance has been made in calculating the compression resistance.

For explanation of table see Section 8.4

Table 44

COMPRESSION

**EQUAL ANGLES
SUBJECT TO AXIAL COMPRESSION**

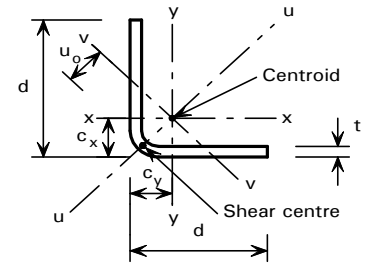

COMPRESSION RESISTANCE FOR GRADE 1.4401 (316) and 1.4404 (316L)

d x d mm	t mm	Mass per Metre kg	Axis	Compression Resistance, P_{cx} , P_{cy} , P_{ouz} , P_{cv} (kN)												
				for Effective Length L_E (m)												
				1.0	1.5	2.0	2.5	3.0	3.5	4.0	5.0	6.0	7.0	8.0	9.0	10.0
150 x 150	* 8.0	17.9	P_{cx}, P_{cy}	301	301	301	295	279	262	244	205	168	136	112	92.7	77.7
			P_{ouz}	227	224	222	219	216	212	208	195	179	161	142	124	108
			P_{cv}	301	296	269	239	207	176	148	106	79.1	60.5	47.7	38.5	31.7
	* 10.0	22.1	P_{cx}, P_{cy}	439	439	439	420	393	365	334	273	218	174	141	116	96.9
			P_{ouz}	355	352	348	343	337	329	319	293	260	227	195	167	144
			P_{cv}	439	419	374	323	272	226	187	131	96.5	73.4	57.6	46.4	38.1
	* 12.0	26.1	P_{cx}, P_{cy}	592	592	590	553	514	471	426	339	266	210	169	138	115
			P_{ouz}	502	497	491	483	472	457	439	394	342	291	246	208	177
			P_{cv}	592	550	481	405	332	270	221	153	111	84.8	66.4	53.3	43.8
	* 15.0	31.9	P_{cx}, P_{cy}	844	844	822	763	699	631	561	433	333	261	208	169	140
			P_{ouz}	747	739	728	712	689	661	627	547	462	384	318	266	224
			P_{cv}	844	751	635	516	410	327	265	181	131	98.9	77.2	62.0	50.8
200 x 200	* 8.0	24.2	P_{cx}, P_{cy}	324	324	324	324	324	324	312	289	263	235	207	181	158
			P_{ouz}	218	214	212	210	209	207	205	201	196	190	182	173	163
			P_{cv}	324	324	324	311	291	271	249	203	163	130	106	87.2	72.7
	* 10.0	30.0	P_{cx}, P_{cy}	479	479	479	479	479	467	449	409	365	319	276	237	204
			P_{ouz}	356	351	348	345	343	340	336	328	316	301	283	263	242
			P_{cv}	479	479	475	444	411	376	339	267	208	164	132	108	89.8
	* 12.0	35.6	P_{cx}, P_{cy}	655	655	655	655	651	625	596	535	469	404	344	292	249
			P_{ouz}	518	512	508	504	500	495	489	473	451	423	391	356	322
			P_{cv}	655	655	634	588	537	482	427	327	251	196	156	127	105
	* 15.0	43.7	P_{cx}, P_{cy}	949	949	949	949	922	879	832	732	627	527	441	371	314
			P_{ouz}	797	789	784	777	769	759	747	713	668	614	554	495	439
			P_{cv}	949	949	890	812	726	637	552	409	308	238	188	153	126

See Section 8.4.2 for guidance on calculating an effective length which allows for both the effects of end fixity and nominal end moments due to eccentricity of connection.

Slender sections must also be checked for the combined effects of the axial load and moment caused by the shift of neutral axis, see Section 8.4.2

* Section is slender under axial compression and allowance has been made in calculating the compression resistance.

For explanation of table see Section 8.4

Table 45

COMPRESSION

**DOUBLE ANGLES BACK TO BACK
SUBJECT TO AXIAL COMPRESSION**

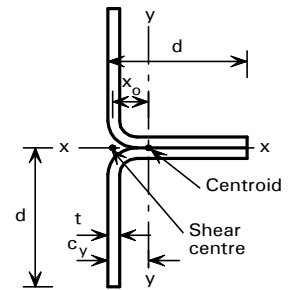

COMPRESSION RESISTANCE FOR GRADE 1.4401 (316) and 1.4404 (316L)

2d x d mm	t mm	Mass per Metre kg	Axis	Compression Resistance, P_{cx} , P_{czz} , P_{cy} (kN)												
				for Effective Length L_E (m)												
				1.0	1.5	2.0	2.5	3.0	3.5	4.0	5.0	6.0	7.0	8.0	9.0	10.0
100 x 50	* 5.0	7.08	P_{cx}	149	119	92.5	71.5	55.9	44.4	36.0	24.8	18.1	13.8	10.8	8.71	7.17
			P_{czz}	157	140	114	88.7	68.3	53.4	42.5	28.6	20.4	15.3	11.9	9.48	7.74
			P_{cy}	124	87.7	61.4	44.3	33.2	25.7	20.4	13.7	9.87	7.42	5.79	4.64	3.80
	6.0	8.30	P_{cx}	183	145	112	86.9	67.8	53.8	43.6	30.0	21.9	16.6	13.1	10.5	8.65
			P_{czz}	199	174	140	108	83.3	64.9	51.6	34.6	24.7	18.5	14.3	11.4	9.34
			P_{cy}	150	104	72.2	51.8	38.6	29.8	23.7	15.9	11.4	8.58	6.69	5.36	4.39
	8.0	10.5	P_{cx}	235	188	147	114	89.9	71.6	58.1	40.2	29.3	22.3	17.5	14.1	11.6
			P_{czz}	260	228	186	144	111	87.1	69.4	46.5	33.2	24.9	19.3	15.4	12.6
			P_{cy}	188	129	89.1	63.8	47.5	36.6	29.0	19.5	14.0	10.5	8.18	6.55	5.36
	10.0	12.5	P_{cx}	283	229	181	141	111	89.4	72.7	50.5	36.9	28.1	22.1	17.8	14.7
			P_{czz}	314	276	229	180	139	109	87.4	58.8	42.0	31.5	24.4	19.5	15.9
			P_{cy}	220	149	102	73.2	54.4	41.9	33.2	22.3	16.0	12.0	9.33	7.47	6.11
150 x 75	* 6.0	13.0	P_{cx}	274	242	211	182	155	132	112	83.1	62.9	49.0	39.2	32.0	26.6
			P_{czz}	245	240	229	211	187	162	138	100	74.5	57.0	44.9	36.2	29.8
			P_{cy}	250	208	169	135	108	88.2	72.4	50.8	37.4	28.6	22.5	18.2	15.0
	* 8.0	16.9	P_{cx}	423	368	317	268	225	189	159	115	87.1	67.5	53.7	43.7	36.2
			P_{czz}	407	394	366	326	280	236	197	140	102	78.1	61.2	49.2	40.4
			P_{cy}	378	305	240	187	147	117	95.9	66.5	48.6	37.0	29.1	23.4	19.3
	10.0	20.4	P_{cx}	518	452	390	332	280	235	198	144	108	84.5	67.3	54.8	45.5
			P_{czz}	518	497	458	408	352	297	248	176	129	98.3	77.0	61.9	50.8
			P_{cy}	458	368	288	224	175	140	113	78.9	57.6	43.8	34.4	27.7	22.8
	12.0	23.7	P_{cx}	604	530	459	392	332	280	237	173	130	101	81.0	66.0	54.8
			P_{czz}	617	586	540	483	419	355	298	212	156	118	93.0	74.8	61.4
			P_{cy}	529	423	330	256	200	159	129	89.5	65.3	49.7	39.0	31.4	25.9
200 x 100	* 8.0	23.2	P_{cx}	517	473	430	389	349	311	276	217	171	137	111	92.5	77.7
			P_{czz}	438	434	427	414	394	366	333	266	208	165	132	108	89.7
			P_{cy}	484	426	370	317	269	228	193	141	107	83.3	66.4	54.2	45.0
	* 10.0	28.3	P_{cx}	728	661	597	535	476	420	370	285	223	177	143	118	99.4
			P_{czz}	652	645	630	601	560	511	457	354	273	213	170	138	114
			P_{cy}	674	585	499	420	350	292	245	177	132	102	81.6	66.3	54.9
	12.0	33.2	P_{cx}	895	812	733	656	582	513	450	347	271	215	174	143	120
			P_{czz}	834	823	797	754	697	632	563	434	333	259	206	167	138
			P_{cy}	823	709	601	501	416	345	288	207	154	119	94.7	76.9	63.6
	15.0	40.0	P_{cx}	1080	986	892	801	713	631	556	430	337	268	217	179	150
			P_{czz}	1040	1030	985	928	860	783	701	543	418	326	259	210	174
			P_{cy}	988	849	717	596	493	408	340	244	181	140	111	90.3	74.7
240 x 120	* 8.0	28.2	P_{cx}	562	535	498	463	428	394	361	300	248	205	171	144	122
			P_{czz}	447	444	441	435	428	416	399	352	298	248	205	171	144
			P_{cy}	546	496	448	402	357	316	278	215	168	133	108	89.3	74.8
	* 10.0	34.6	P_{cx}	810	759	703	648	595	543	493	403	329	269	223	186	158
			P_{czz}	682	677	670	659	641	613	577	491	404	329	269	222	186
			P_{cy}	773	696	621	549	481	419	364	276	212	167	135	111	92.7
	* 12.0	40.8	P_{cx}	1080	1000	922	846	771	700	631	510	411	334	275	229	194
			P_{czz}	942	935	924	902	866	818	760	632	510	410	333	273	228
			P_{cy}	1020	906	800	699	605	520	447	334	255	200	160	131	109
	15.0	49.5	P_{cx}	1380	1270	1170	1080	980	888	801	645	520	422	347	289	244
			P_{czz}	1260	1250	1230	1190	1130	1060	981	811	652	522	422	346	288
			P_{cy}	1290	1140	1000	868	746	638	546	404	307	240	192	157	130

See Section 8.4.2 for guidance on calculating an effective length which allows for both the effects of end fixity and nominal end moments due to eccentricity of connection.

Slender sections must also be checked for the combined effects of the axial load and moment caused by the shift of neutral axis, see Section 8.4.2.

* Section is slender under axial compression and allowance has been made in calculating the compression resistance.

Table 45

COMPRESSION

**DOUBLE ANGLES BACK TO BACK
SUBJECT TO AXIAL COMPRESSION**

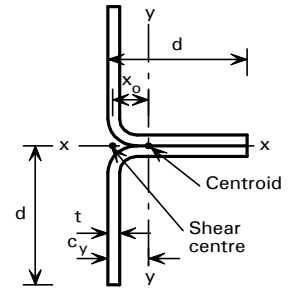

COMPRESSION RESISTANCE FOR GRADE 1.4401 (316) and 1.4404 (316L)

2d x d mm	t mm	Mass per Metre kg	Axis	Compression Resistance, P_{cx} , P_{cxz} , P_{cy} (kN)												
				for Effective Length L_E (m)												
				1.0	1.5	2.0	2.5	3.0	3.5	4.0	5.0	6.0	7.0	8.0	9.0	10.0
300 x 150	* 8.0	35.8	P_{cx}	603	603	575	545	517	489	461	407	356	310	269	234	203
			P_{cxz}	448	443	441	438	435	431	426	411	386	352	313	275	241
			P_{cy}	603	575	536	498	461	425	390	325	269	223	186	157	133
	* 10.0	44.1	P_{cx}	879	872	824	779	734	690	647	564	487	418	359	309	267
			P_{cxz}	702	697	693	689	683	674	662	623	566	500	433	373	321
			P_{cy}	879	822	760	701	643	586	532	434	353	289	239	200	169
	* 12.0	52.2	P_{cx}	1190	1160	1100	1030	969	907	846	729	622	529	451	385	332
			P_{cxz}	992	986	980	972	961	944	919	846	750	648	552	470	401
			P_{cy}	1180	1090	1000	916	832	752	676	542	435	352	289	240	203
	* 15.0	63.7	P_{cx}	1690	1640	1540	1440	1350	1250	1160	987	832	700	591	502	430
			P_{cxz}	1480	1470	1460	1440	1420	1380	1330	1190	1030	871	731	614	520
			P_{cy}	1660	1520	1380	1250	1120	1000	890	699	552	443	360	298	250
400 x 200	* 8.0	48.5	P_{cx}	649	649	649	639	617	596	575	534	494	454	416	380	346
			P_{cxz}	430	422	418	416	414	413	411	407	402	394	384	371	354
			P_{cy}	649	649	634	605	577	550	523	471	421	373	330	291	256
	* 10.0	59.9	P_{cx}	959	959	959	931	896	862	829	763	699	637	578	522	471
			P_{cxz}	702	692	688	685	682	679	675	666	653	634	607	573	532
			P_{cy}	959	959	920	874	830	786	743	660	580	507	442	385	336
	* 12.0	71.1	P_{cx}	1310	1310	1310	1260	1210	1160	1110	1010	921	832	749	671	601
			P_{cxz}	1020	1010	1010	1000	997	992	986	969	942	901	846	780	711
			P_{cy}	1310	1310	1240	1170	1110	1040	979	858	745	643	554	478	415
	* 15.0	87.4	P_{cx}	1900	1900	1870	1790	1710	1640	1560	1420	1280	1140	1020	902	801
			P_{cxz}	1570	1560	1550	1550	1540	1530	1520	1480	1410	1320	1210	1090	977
			P_{cy}	1900	1860	1760	1650	1550	1450	1350	1170	994	845	720	615	530

See Section 8.4.2 for guidance on calculating an effective length which allows for both the effects of end fixity and nominal end moments due to eccentricity of connection.

Slender sections must also be checked for the combined effects of the axial load and moment caused by the shift of neutral axis, see Section 8.4.2.

* Section is slender under axial compression and allowance has been made in calculating the compression resistance.

Table 46

TENSION

**EQUAL ANGLES
SUBJECT TO AXIAL TENSION**

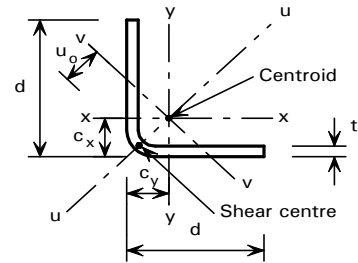

TENSION CAPACITY FOR GRADE 1.4401 (316) and 1.4404 (316L)

d x d mm	t mm	Mass per Metre kg	Radius of Gyration v-v axis cm	Gross Area cm ²	Weld or Bolt Size	Holes Deducted From Angle		Equivalent Tension Area cm ²	Tension Capacity kN
						No.	Diameter mm		
50 x 50	5.0	3.54	0.892	4.48	Weld	0	-	3.89	85.5
					M12	1	13	3.21	70.6
50 x 50	6.0	4.15	0.861	5.25	Weld	0	-	4.58	100
					M12	1	13	3.79	83.4
50 x 50	8.0	5.27	0.797	6.67	Weld	0	-	5.87	129
					M12	1	13	4.89	107
50 x 50	10.0	6.26	0.732	7.93	Weld	0	-	7.05	155
					M12	1	13	5.90	129
75 x 75	6.0	6.52	1.38	8.25	Weld	0	-	7.13	156
					M16	1	18	5.98	131
					M20	1	22	5.69	125
75 x 75	8.0	8.43	1.32	10.7	Weld	0	-	9.27	203
					M16	1	18	7.81	171
					M20	1	22	7.42	163
75 x 75	10.0	10.2	1.26	12.9	Weld	0	-	11.3	248
					M16	1	18	9.55	210
					M20	1	22	9.07	199
75 x 75	12.0	11.9	1.20	15.0	Weld	0	-	13.2	290
					M16	1	18	11.2	246
					M20	1	22	10.6	234
100 x 100	8.0	11.6	1.84	14.7	Weld	0	-	12.7	278
					M20	1	22	10.8	238
					M24	1	26	10.4	229
100 x 100	10.0	14.2	1.78	17.9	Weld	0	-	15.5	342
					M20	1	22	13.3	293
					M24	1	26	12.8	282
100 x 100	12.0	16.6	1.72	21.0	Weld	0	-	18.3	402
					M20	1	22	15.7	346
					M24	1	26	15.2	333
100 x 100	15.0	20.0	1.63	25.3	Weld	0	-	22.2	489
					M20	1	22	19.2	422
					M24	1	26	18.5	406
120 x 120	8.0	14.1	2.25	17.9	Weld	0	-	15.4	338
					M20	1	22	13.5	297
					M24	1	26	13.2	289
120 x 120	10.0	17.3	2.20	21.9	Weld	0	-	18.9	416
					M20	1	22	16.7	367
					M24	1	26	16.2	357
120 x 120	12.0	20.4	2.14	25.8	Weld	0	-	22.4	492
					M20	1	22	19.8	436
					M24	1	26	19.2	423
120 x 120	15.0	24.8	2.05	31.3	Weld	0	-	27.3	601
					M20	1	22	24.3	534
					M24	1	26	23.6	518
150 x 150	8.0	17.9	2.87	22.7	Weld	0	-	19.5	428
					M20	1	22	17.3	381
					M20	2	22	15.5	341
					M24	1	26	17.2	379
150 x 150	10.0	22.1	2.82	27.9	Weld	0	-	24.0	529
					M20	1	22	21.5	472
					M20	2	22	19.2	422
					M24	1	26	21.3	469

The capacity of the bolts must also be checked.

For explanation of table see Section 8.5

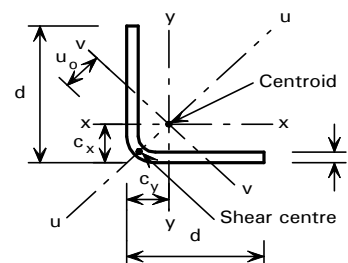
Table 46**TENSION****EQUAL ANGLES
SUBJECT TO AXIAL TENSION****TENSION CAPACITY FOR GRADE 1.4401 (316) and 1.4404 (316L)**

d x d mm	t mm	Mass per Metre kg	Radius of Gyration v-v axis cm	Gross Area cm ²	Weld or Bolt Size	Holes Deducted From Angle		Equivalent Tension Area cm ²	Tension Capacity kN
						No.	Diameter mm		
150 x 150	12.0	26.1	2.76	33.0	Weld	0	-	28.5	627
					M20	1	22	25.5	561
					M20	2	22	22.8	500
					M24	1	26	25.4	557
150 x 150	15.0	31.9	2.67	40.3	Weld	0	-	35.0	769
					M20	1	22	31.4	691
					M20	2	22	28.0	615
					M24	1	26	31.2	687
200 x 200	8.0	24.2	3.90	30.7	Weld	0	-	26.3	577
					M20	3	22	20.2	444
					M24	1	26	23.3	513
					M24	2	26	21.5	473
200 x 200	10.0	30.0	3.85	37.9	Weld	0	-	32.5	716
					M20	3	22	25.0	550
					M24	1	26	29.0	637
					M24	2	26	26.7	587
200 x 200	12.0	35.6	3.79	45.0	Weld	0	-	38.7	851
					M20	3	22	29.8	655
					M24	1	26	34.5	759
					M24	2	26	31.8	700
200 x 200	15.0	43.7	3.71	55.3	Weld	0	-	47.7	1050
					M20	3	22	36.8	809
					M24	1	26	42.7	938
					M24	2	26	39.3	864

The capacity of the bolts must also be checked.

For explanation of table see Section 8.5

Table 47

TENSION
TWO EQUAL ANGLES
BACK TO BACK
SUBJECT TO AXIAL TENSION

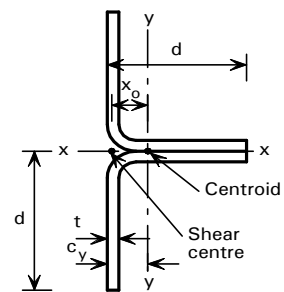

TENSION CAPACITY FOR GRADE 1.4401 (316) and 1.4404 (316L)

2d x d mm	t mm	Mass per Metre kg	Radius of Gyration		Gross Area cm ²	Weld or Bolt Size	Holes Deducted From Angle		Gusset Between Angles		Gusset On Back of Angles	
			Axis x-x cm	Axis y-y cm			No.	Diameter mm	Equivalent Tension Area cm ²	Tension Capacity kN	Equivalent Tension Area cm ²	Tension Capacity kN
100 x 50	5.0	7.08	2.17	1.55	8.96	Weld M12	0	-	8.37	184	7.77	171
							1	13	7.41	163	6.42	141
100 x 50	6.0	8.30	2.20	1.53	10.5	Weld M12	0	-	9.83	216	9.16	201
							1	13	8.71	191	7.58	166
100 x 50	8.0	10.5	2.26	1.50	13.3	Weld M12	0	-	12.5	275	11.7	258
							1	13	11.1	244	9.78	215
100 x 50	10.0	12.5	2.34	1.47	15.9	Weld M12	0	-	15.0	329	14.1	310
							1	13	13.3	291	11.8	259
150 x 75	6.0	13.0	3.21	2.34	16.5	Weld M16	0	-	15.4	338	14.3	313
							1	18	13.8	304	12.0	263
							1	22	13.3	291	11.4	250
150 x 75	8.0	16.9	3.27	2.31	21.3	Weld M16	0	-	19.9	438	18.5	407
							1	18	18.0	394	15.6	343
							1	22	17.2	378	14.8	326
150 x 75	10.0	20.4	3.33	2.28	25.9	Weld M16	0	-	24.2	532	22.6	497
							1	18	21.8	480	19.1	420
							1	22	20.9	458	18.1	399
150 x 75	12.0	23.7	3.40	2.25	30.0	Weld M16	0	-	28.2	620	26.4	581
							1	18	25.4	559	22.4	493
							1	22	24.3	534	21.3	468
200 x 100	8.0	23.2	4.28	3.12	29.3	Weld M20	0	-	27.3	601	25.3	557
							1	22	25.0	549	21.6	476
							1	26	24.2	532	20.9	459
200 x 100	10.0	28.3	4.33	3.09	35.9	Weld M20	0	-	33.5	736	31.1	684
							1	22	30.6	673	26.6	586
							1	26	29.7	652	25.7	565
200 x 100	12.0	33.2	4.40	3.06	42.0	Weld M20	0	-	39.3	865	36.6	805
							1	22	36.0	791	31.5	692
							1	26	34.8	766	30.3	667
200 x 100	15.0	40.0	4.49	3.02	50.7	Weld M20	0	-	47.6	1050	44.5	978
							1	22	43.6	958	38.4	845
							1	26	42.1	927	37.0	813
240 x 120	8.0	28.2	5.09	3.77	35.7	Weld M20	0	-	33.3	731	30.8	677
							1	22	31.2	686	27.1	595
							1	26	30.5	670	26.3	579
240 x 120	10.0	34.6	5.14	3.74	43.9	Weld M20	0	-	40.9	899	37.9	833
							1	22	38.4	845	33.4	735
							1	26	37.5	823	32.5	714
240 x 120	12.0	40.8	5.20	3.71	51.6	Weld M20	0	-	48.2	1060	44.8	985
							1	22	45.3	997	39.6	872
							1	26	44.2	972	38.5	846
240 x 120	15.0	49.5	5.29	3.67	62.7	Weld M20	0	-	58.7	1290	54.7	1200
							1	22	55.3	1220	48.6	1070
							1	26	53.8	1180	47.2	1040
300 x 150	8.0	35.8	6.31	4.74	45.3	Weld M20	0	-	42.1	927	38.9	856
							1	22	40.0	880	34.7	762
							2	22	36.4	799	31.0	682
							1	26	39.8	875	34.5	758
300 x 150	10.0	44.1	6.36	4.71	55.9	Weld M20	0	-	52.0	1140	48.1	1060
							1	22	49.4	1090	42.9	944
							2	22	44.8	986	38.4	844
							1	26	49.2	1080	42.7	939

The capacity of the bolts must also be checked.

For explanation of table see Section 8.5

Table 47

TENSION
TWO EQUAL ANGLES
BACK TO BACK
SUBJECT TO AXIAL TENSION

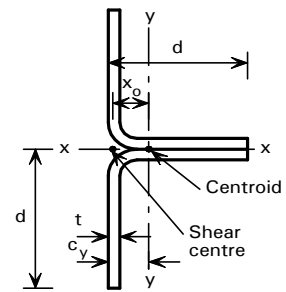

TENSION CAPACITY FOR GRADE 1.4401 (316) and 1.4404 (316L)

2d x d mm	t mm	Mass per Metre kg	Radius of Gyration		Gross Area cm ²	Weld or Bolt Size	Holes Deducted From Angle		Gusset Between Angles		Gusset On Back of Angles	
			Axis x-x cm	Axis y-y cm			No.	Diameter mm	Equivalent Tension Area cm ²	Tension Capacity kN	Equivalent Tension Area cm ²	Tension Capacity kN
300 x 150	12.0	52.2	6.42	4.68	66.0	Weld	0	-	61.5	1350	57.0	1250
						M20	1	22	58.5	1290	51.0	1120
						M20	2	22	53.1	1170	45.5	1000
						M24	1	26	58.2	1280	50.7	1120
300 x 150	15.0	63.7	6.50	4.64	80.7	Weld	0	-	75.3	1660	70.0	1540
						M20	1	22	71.8	1580	62.8	1380
						M20	2	22	64.9	1430	56.0	1230
						M24	1	26	71.4	1570	62.5	1370
400 x 200	8.0	48.5	8.35	6.35	61.3	Weld	0	-	56.9	1250	52.5	1160
						M20	3	22	47.7	1050	40.4	888
						M24	1	26	54.0	1190	46.7	1030
						M24	2	26	50.4	1110	43.1	947
400 x 200	10.0	59.9	8.40	6.32	75.9	Weld	0	-	70.5	1550	65.1	1430
						M20	3	22	59.1	1300	50.1	1100
						M24	1	26	66.9	1470	57.9	1270
						M24	2	26	62.4	1370	53.4	1180
400 x 200	12.0	71.1	8.45	6.30	90.0	Weld	0	-	83.7	1840	77.4	1700
						M20	3	22	70.1	1540	59.6	1310
						M24	1	26	79.5	1750	69.0	1520
						M24	2	26	74.1	1630	63.6	1400
400 x 200	15.0	87.4	8.53	6.26	110	Weld	0	-	103	2270	95.5	2100
						M20	3	22	86.2	1900	73.6	1620
						M24	1	26	98.0	2160	85.3	1880
						M24	2	26	91.3	2010	78.6	1730

The capacity of the bolts must also be checked.

For explanation of table see Section 8.5

Table 48

BENDING

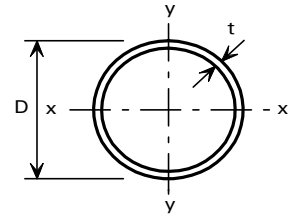
CIRCULAR HOLLOW SECTIONS
SUBJECT TO BENDING

MOMENT AND SHEAR CAPACITY FOR GRADE 1.4401 (316) and 1.4404 (316L)

D mm	t mm	Mass per Metre kg	Section Classification	Moment Capacity M_c kNm	Second Moment Of Area I_x, I_y cm ⁴	Shear Capacity P_v kN
21.3	1.0	0.50	Plastic	<i>0.0816</i>	0.329	5.05
	1.2	0.60	Plastic	<i>0.0952</i>	0.384	6.00
	1.6	0.78	Plastic	<i>0.120</i>	0.484	7.84
	2.0	0.96	Plastic	<i>0.141</i>	0.571	9.60
	2.3	1.08	Plastic	<i>0.156</i>	0.629	10.9
33.7	1.0	0.81	Plastic	<i>0.215</i>	1.37	8.14
	1.6	1.27	Plastic	<i>0.326</i>	2.08	12.8
	2.0	1.57	Plastic	<i>0.394</i>	2.51	15.8
	2.5	1.94	Plastic	<i>0.470</i>	3.00	19.4
	3.2	2.42	Plastic	<i>0.565</i>	3.60	24.3
42.4	1.0	1.03	Plastic	<i>0.347</i>	2.79	10.3
	1.6	1.62	Plastic	<i>0.532</i>	4.27	16.2
	2.0	2.01	Plastic	<i>0.646</i>	5.19	20.1
	2.6	2.57	Plastic	<i>0.805</i>	6.46	25.7
	3.2	3.11	Plastic	<i>0.949</i>	7.62	31.2
48.3	1.0	1.17	Plastic	<i>0.454</i>	4.16	11.8
	1.6	1.85	Plastic	<i>0.700</i>	6.41	18.6
	2.0	2.30	Plastic	<i>0.854</i>	7.81	23.0
	2.6	2.95	Plastic	<i>1.07</i>	9.78	29.6
	3.2	3.58	Plastic	<i>1.27</i>	11.6	35.9
60.3	1.0	1.47	Compact	<i>0.717</i>	8.19	14.8
	1.6	2.33	Plastic	<i>1.11</i>	12.7	23.4
	2.0	2.89	Plastic	<i>1.36</i>	15.6	29.0
	2.6	3.72	Plastic	<i>1.72</i>	19.7	37.3
	3.2	4.53	Plastic	<i>2.05</i>	23.5	45.5
	4.0	5.59	Plastic	<i>2.47</i>	28.2	56.0
	5.0	6.86	Plastic	<i>2.93</i>	33.5	68.8
76.1	1.0	1.86	Semi-compact	<i>0.962</i>	16.6	18.7
	1.6	2.96	Plastic	<i>1.80</i>	26.0	29.7
	2.0	3.68	Plastic	<i>2.22</i>	32.0	36.9
	2.6	4.74	Plastic	<i>2.82</i>	40.6	47.5
	3.2	5.79	Plastic	<i>3.38</i>	48.8	58.0
	4.0	7.16	Plastic	<i>4.10</i>	59.1	71.8
	5.0	8.82	Plastic	<i>4.92</i>	70.9	88.5
88.9	1.0	2.18	Semi-compact	<i>1.32</i>	26.7	21.9
	1.6	3.47	Compact	<i>2.48</i>	41.8	34.8
	2.0	4.31	Plastic	<i>3.06</i>	51.6	43.2
	2.6	5.57	Plastic	<i>3.90</i>	65.7	55.8
	3.2	6.81	Plastic	<i>4.70</i>	79.2	68.2
	4.0	8.43	Plastic	<i>5.72</i>	96.3	84.5
	5.0	10.4	Plastic	<i>6.91</i>	116	104
101.6	1.0	2.50	Semi-compact	<i>1.73</i>	40.0	25.0
	1.6	3.97	Compact	<i>3.27</i>	62.8	39.8
	2.0	4.94	Compact	<i>4.03</i>	77.6	49.6
	2.6	6.39	Plastic	<i>5.15</i>	99.1	64.0
	3.2	7.81	Plastic	<i>6.23</i>	119	78.3
	4.0	9.69	Plastic	<i>7.60</i>	146	97.1
	5.0	12.0	Plastic	<i>9.22</i>	177	120

M_c values in *italic type* are governed by $1.2p_y Z$ and a higher value may be used in some circumstances.

For explanation of table see Section 8.6.

Table 48

BENDING

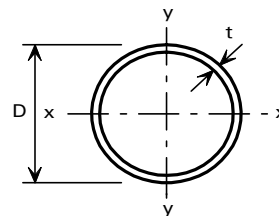
CIRCULAR HOLLOW SECTIONS
SUBJECT TO BENDING

MOMENT AND SHEAR CAPACITY FOR GRADE 1.4401 (316) and 1.4404 (316L)

D mm	t mm	Mass per Metre kg	Section Classification	Moment Capacity M_c kNm	Second Moment Of Area I_x, I_y cm ⁴	Shear Capacity P_v kN
114.3	1.2	3.37	Semi-compact	2.62	68.2	33.8
	1.6	4.48	Semi-compact	3.46	90.0	44.9
	2.0	5.57	Compact	5.14	111	55.9
	2.6	7.21	Plastic	6.58	142	72.3
	3.2	8.82	Plastic	7.97	172	88.5
	4.0	10.9	Plastic	9.75	211	109
139.7	5.0	13.6	Plastic	11.9	256	135
	1.2	4.12	Semi-compact	3.94	125	41.4
	1.6	5.48	Semi-compact	5.21	165	55.0
	2.0	6.84	Compact	7.75	205	68.5
	2.6	8.85	Compact	9.95	263	88.7
	3.2	10.8	Plastic	12.1	319	108
168.3	4.0	13.5	Plastic	14.8	392	135
	5.0	16.7	Plastic	18.2	480	167
	1.6	6.62	Semi-compact	7.61	291	66.4
	2.0	8.25	Semi-compact	9.44	361	82.8
	2.6	10.7	Compact	14.6	464	107
	3.2	13.1	Compact	17.7	565	131
219.1	4.0	16.3	Plastic	21.9	697	163
	5.0	20.3	Plastic	26.9	855	203
	2.0	10.8	Semi-compact	16.1	803	108
	2.6	14.0	Semi-compact	20.8	1040	140
	3.2	17.1	Compact	30.5	1260	171
273	4.0	21.4	Compact	37.7	1560	214
	5.0	26.6	Compact	46.5	1930	266
	2.6	17.4	Semi-compact	32.5	2020	174
	3.2	21.4	Semi-compact	39.8	2470	214
	4.0	26.7	Compact	59.1	3060	267
	5.0	33.3	Compact	73.1	3780	333

M_c values in *italic type* are governed by $1.2p_y Z$ and a higher value may be used in some circumstances.

For explanation of table see Section 8.6.

Table 49

BENDING

**RECTANGULAR HOLLOW SECTIONS
SUBJECT TO BENDING**

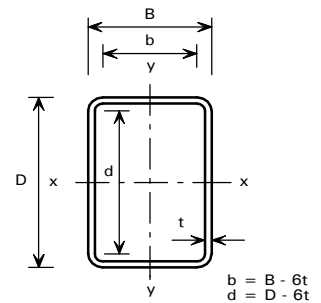

MOMENT CAPACITY AND LIMITING LENGTHS FOR GRADE 1.4401 (316) and 1.4404 (316L)

D x B mm	t mm	Mass per Metre kg	Section Classification		Moment Capacity		Limiting Length L _c m	Second Moment Of Area		Shear Capacity P _v kN
			Bending About x-x Axis	Bending About y-y Axis	M _{cx} kNm	M _{cy} kNm		I _x cm ⁴	I _y cm ⁴	
50 x 25	1.5	1.63	Plastic	Compact	<i>0.677</i>	0.441	4.62	6.41	2.19	18.2
	2.0	2.11	Plastic	Plastic	<i>0.839</i>	0.556	4.59	7.95	2.70	23.5
60 x 30	2.0	2.58	Plastic	Plastic	<i>1.27</i>	0.832	5.54	14.4	4.92	28.8
	3.0	3.68	Plastic	Plastic	<i>1.68</i>	<i>1.13</i>	5.47	19.1	6.44	41.0
80 x 40	2.0	3.53	Plastic	Slender	<i>2.39</i>	1.31	7.41	36.2	12.4	39.3
	3.0	5.10	Plastic	Plastic	<i>3.28</i>	2.17	7.36	49.7	16.9	56.8
	4.0	6.54	Plastic	Plastic	<i>3.98</i>	<i>2.69</i>	7.29	60.3	20.4	72.8
100 x 50	2.0	4.48	Plastic	Slender	<i>3.87</i>	1.89	9.29	73.2	25.2	49.9
	3.0	6.52	Plastic	Compact	<i>5.41</i>	3.53	9.25	102	35.1	72.6
	4.0	8.43	Plastic	Plastic	<i>6.71</i>	4.45	9.19	127	43.2	93.9
	5.0	10.2	Plastic	Plastic	<i>7.77</i>	5.25	9.11	147	49.7	113
150 x 75	6.0	11.9	Plastic	Plastic	<i>8.60</i>	<i>5.78</i>	9.01	162	54.7	132
	3.0	10.1	Plastic	Slender	<i>13.1</i>	6.38	13.9	370	127	112
	4.0	13.2	Plastic	Slender	<i>16.6</i>	9.42	13.9	472	161	146
	5.0	16.1	Plastic	Plastic	<i>19.8</i>	13.0	13.8	563	192	179
150 x 100	6.0	19.0	Plastic	Plastic	<i>22.7</i>	15.0	13.8	643	218	211
	8.0	24.2	Plastic	Plastic	<i>27.3</i>	<i>18.4</i>	13.6	774	260	270
	3.0	11.3	Compact	Slender	<i>15.9</i>	9.24	27.1	451	243	112
	4.0	14.8	Plastic	Slender	<i>20.4</i>	13.6	27.2	578	311	147
150 x 100	5.0	18.1	Plastic	Plastic	<i>24.5</i>	19.0	27.3	694	373	181
	6.0	21.3	Plastic	Plastic	<i>28.1</i>	22.0	27.4	799	428	213
	8.0	27.4	Plastic	Plastic	<i>34.4</i>	27.5	27.5	976	521	274
	4.0	17.9	Plastic	Slender	<i>30.9</i>	15.1	18.6	1170	403	199
200 x 100	5.0	22.1	Plastic	Slender	<i>37.4</i>	20.5	18.5	1420	485	245
	6.0	26.1	Plastic	Compact	<i>43.3</i>	28.2	18.5	1640	561	290
	8.0	33.7	Plastic	Plastic	<i>53.7</i>	35.6	18.4	2030	690	375
	10.0	40.8	Plastic	Plastic	<i>62.2</i>	<i>42.0</i>	18.2	2360	795	455
	4.0	19.5	Plastic	Slender	<i>36.0</i>	20.1	30.7	1360	666	200
200 x 125	5.0	24.0	Plastic	Slender	<i>43.7</i>	27.3	30.8	1650	805	247
	6.0	28.5	Plastic	Compact	<i>50.8</i>	37.7	30.8	1920	935	292
	8.0	36.9	Plastic	Plastic	<i>63.4</i>	47.9	30.9	2400	1160	379
	10.0	44.8	Plastic	Plastic	<i>74.1</i>	56.9	30.9	2810	1360	460
	6.0	33.2	Plastic	Slender	<i>70.6</i>	37.9	23.2	3340	1150	369
250 x 125	8.0	43.2	Plastic	Plastic	<i>89.0</i>	58.2	23.1	4210	1440	481
	10.0	52.7	Plastic	Plastic	<i>104</i>	69.5	23.0	4970	1690	587
	12.0	61.7	Plastic	Plastic	<i>118</i>	79.6	22.8	5610	1900	686
	15.0	74.1	Plastic	Plastic	<i>134</i>	<i>90.3</i>	22.5	6360	2140	825
	6.0	35.6	Plastic	Slender	<i>80.0</i>	47.9	34.9	3790	1730	371
250 x 150	8.0	46.4	Plastic	Plastic	<i>101</i>	73.8	34.9	4800	2190	484
	10.0	56.6	Plastic	Plastic	<i>120</i>	88.6	34.9	5690	2580	591
	12.0	66.4	Plastic	Plastic	<i>136</i>	101	34.9	6460	2930	693
	15.0	80.1	Plastic	Plastic	<i>156</i>	<i>117</i>	34.8	7400	3340	836
	6.0	40.3	Plastic	Slender	<i>104</i>	51.0	27.9	5930	2040	448
300 x 150	8.0	52.7	Plastic	Slender	<i>133</i>	75.4	27.8	7560	2590	586
	10.0	64.5	Plastic	Plastic	<i>158</i>	103	27.7	9010	3070	719
	12.0	75.9	Plastic	Plastic	<i>181</i>	120	27.6	10300	3500	845
	15.0	91.9	Plastic	Plastic	<i>209</i>	<i>141</i>	27.3	11900	4030	1020
	6.0	45.0	Compact	Slender	<i>127</i>	73.9	54.2	7230	3900	451
300 x 200	8.0	59.0	Plastic	Slender	<i>163</i>	108	54.4	9260	4990	591
	10.0	72.4	Plastic	Plastic	<i>195</i>	151	54.6	11100	5970	726
	12.0	85.4	Plastic	Plastic	<i>225</i>	176	54.7	12800	6850	855
	15.0	103	Plastic	Plastic	<i>263</i>	209	54.9	15000	8000	1040

Moment capacity values in *italic type* are governed by 1.2p_yZ and a higher value may be used in some circumstances.

Lengths above the limiting length L_c should be checked for lateral torsional buckling.

For explanation of table see Section 8.6.

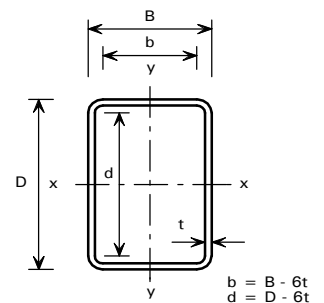
Table 49**BENDING****RECTANGULAR HOLLOW SECTIONS
SUBJECT TO BENDING****MOMENT CAPACITY AND LIMITING LENGTHS FOR GRADE 1.4401 (316) and 1.4404 (316L)**

D x B mm	t mm	Mass per Metre kg	Section Classification		Moment Capacity		Limiting Length L_c m	Second Moment Of Area		Shear Capacity P_v kN
			Bending About x-x Axis	Bending About y-y Axis	M_{cx} kNm	M_{cy} kNm		I_x cm ⁴	I_y cm ⁴	
350 x 175	6.0	47.4	Plastic	Slender	<i>144</i>	65.2	32.5	9600	3320	528
	8.0	62.2	Plastic	Slender	<i>185</i>	97.4	32.5	12300	4240	692
	10.0	76.4	Plastic	Semi-compact	<i>223</i>	127	32.4	14800	5070	851
	12.0	90.1	Plastic	Plastic	<i>257</i>	168	32.3	17100	5810	1000
	15.0	109	Plastic	Plastic	<i>301</i>	201	32.1	20000	6780	1220
350 x 200	6.0	49.8	Compact	Slender	<i>158</i>	77.5	43.5	10500	4460	529
	8.0	65.3	Plastic	Slender	<i>203</i>	115	43.6	13500	5720	694
	10.0	80.3	Plastic	Semi-compact	<i>245</i>	151	43.6	16200	6870	854
	12.0	94.8	Plastic	Plastic	<i>283</i>	201	43.6	18800	7920	1010
	15.0	115	Plastic	Plastic	<i>333</i>	240	43.5	22100	9290	1230
400 x 200	6.0	54.5	Semi-compact	Slender	<i>159</i>	80.5	56.2	14500	5030	607
	8.0	71.6	Plastic	Slender	<i>247</i>	120	37.1	18800	6460	798
	10.0	88.2	Plastic	Slender	<i>299</i>	164	37.1	22700	7780	983
	12.0	104	Plastic	Compact	<i>346</i>	225	37.0	26200	8980	1160
	15.0	127	Plastic	Plastic	<i>410</i>	270	36.8	31100	10600	1420
400 x 250	6.0	59.3	Slender	Slender	<i>177</i>	107	96.0	16900	8250	609
	8.0	78.0	Plastic	Slender	<i>288</i>	161	61.5	21800	10700	801
	10.0	96.1	Plastic	Slender	<i>349</i>	218	61.6	26500	12900	988
	12.0	113	Plastic	Compact	<i>406</i>	301	61.7	30800	15000	1170
	15.0	139	Plastic	Plastic	<i>483</i>	363	61.8	36600	17800	1430

Moment capacity values in *italic type* are governed by $1.2p_y Z$ and a higher value may be used in some circumstances.

Lengths above the limiting length L_c should be checked for lateral torsional buckling.

For explanation of table see Section 8.6.

Table 50

BENDING

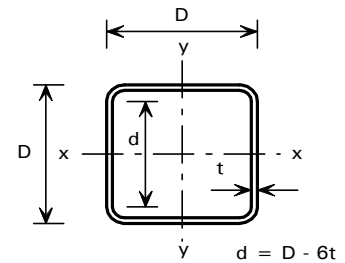
SQUARE HOLLOW SECTIONS
SUBJECT TO BENDING

MOMENT AND SHEAR CAPACITY FOR GRADE 1.4401 (316) and 1.4404 (316L)

D x D mm	t mm	Mass per Metre kg	Section Classification	Moment Capacity M_c kNm	Second Moment Of Area I_x, I_y cm ⁴	Shear Capacity P_v kN
40 x 40	2.0	2.27	Plastic	<i>0.879</i>	6.66	18.9
	3.0	3.20	Plastic	<i>1.15</i>	8.69	26.8
50 x 50	2.0	2.90	Plastic	1.43	13.7	24.2
	3.0	4.15	Plastic	1.95	18.5	34.7
	4.0	5.27	Plastic	2.32	22.0	44.0
60 x 60	2.0	3.53	Plastic	2.11	24.5	29.5
	3.0	5.10	Plastic	2.97	33.7	42.6
	4.0	6.54	Plastic	3.61	41.0	54.6
	5.0	7.84	Plastic	4.09	46.5	65.5
80 x 80	2.0	4.79	Slender	3.22	60.6	40.1
	3.0	6.99	Plastic	5.53	85.3	58.4
	4.0	9.06	Plastic	7.03	106	75.7
	5.0	11.0	Plastic	8.21	124	91.9
100 x 100	3.0	8.89	Compact	8.89	173	74.3
	4.0	11.6	Plastic	11.4	219	96.8
	5.0	14.2	Plastic	13.7	260	118
	6.0	16.6	Plastic	15.6	295	138
	8.0	21.1	Plastic	18.6	351	176
125 x 125	3.0	11.3	Slender	11.6	348	94.1
	4.0	14.8	Plastic	18.4	446	123
	5.0	18.1	Plastic	22.3	535	151
	6.0	21.3	Plastic	25.9	616	178
	8.0	27.4	Plastic	31.8	752	228
150 x 150	3.0	13.6	Slender	15.8	613	113
	4.0	17.9	Slender	23.1	792	149
	5.0	22.1	Plastic	32.9	957	184
	6.0	26.1	Plastic	38.5	1110	217
	8.0	33.7	Plastic	48.6	1380	281
175 x 175	4.0	21.1	Slender	30.0	1280	176
	5.0	26.0	Semi-compact	39.2	1560	217
	6.0	30.8	Plastic	53.6	1820	257
	8.0	40.0	Plastic	68.4	2280	334
	10.0	48.7	Plastic	80.9	2680	407
200 x 200	4.0	24.2	Slender	37.5	1940	202
	5.0	30.0	Slender	50.3	2370	250
	6.0	35.6	Compact	71.2	2770	297
	8.0	46.4	Plastic	91.4	3510	387
	10.0	56.6	Plastic	109	4160	473
250 x 250	5.0	37.9	Slender	73.2	4740	316
	6.0	45.0	Slender	93.2	5570	376
	8.0	59.0	Plastic	147	7140	492
	10.0	72.4	Plastic	178	8570	605
	12.0	85.4	Plastic	207	9860	713
300 x 300	5.0	45.8	Slender	99.1	8320	382
	6.0	54.5	Slender	126	9820	455
	8.0	71.6	Slender	184	12700	598
	10.0	88.2	Plastic	263	15300	737
	12.0	104	Plastic	308	17800	871
350 x 350	6.0	64.0	Slender	163	15800	534
	8.0	84.3	Slender	239	20500	704
	10.0	104	Semi-compact	313	24900	869
	12.0	123	Plastic	428	29100	1030
	15.0	151	Plastic	518	34700	1260

M_c values in *italic type* are governed by $1.2p_y Z$ and a higher value may be used in some circumstances.

For explanation of table see Section 8.6.

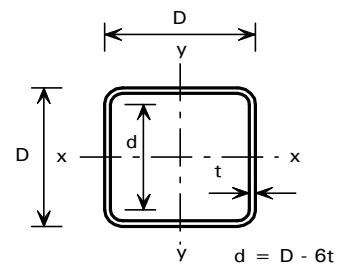
Table 50**BENDING****SQUARE HOLLOW SECTIONS
SUBJECT TO BENDING****MOMENT AND SHEAR CAPACITY FOR GRADE 1.4401 (316) and 1.4404 (316L)**

D x D mm	t mm	Mass per Metre kg	Section Classification	Moment Capacity M_c kNm	Second Moment Of Area I_x, I_y cm ⁴	Shear Capacity P_v kN
400 x 400	6.0	73.5	Slender	203	23900	613
	8.0	96.9	Slender	299	31000	809
	10.0	119	Slender	402	37900	1000
	12.0	142	Compact	569	44300	1190
	15.0	174	Plastic	691	53300	1460

M_c values in *italic type* are governed by $1.2p_y Z$ and a higher value may be used in some circumstances.

For explanation of table see Section 8.6.

Table 51

BENDING

**CHANNELS
SUBJECT TO BENDING**

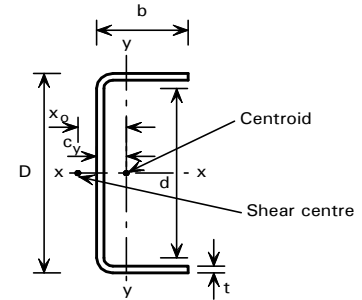

MOMENT CAPACITY AND BUCKLING RESISTANCE MOMENT FOR GRADE 1.4401 (316) and 1.4404 (316L)

D x b mm	t mm	Section Classification	Moment Capacity		Buckling Resistance Moment, M_b (kNm)													Shear Capacity P_v kN
			M_{cx} kNm	M_{cy} kNm	for Effective lengths, L_E (m)													
					1.0	1.5	2.0	2.5	3.0	3.5	4.0	5.0	6.0	7.0	8.0	9.0	10.0	
50 x 25	2.0	Slender Plastic	0.596	0.132	0.449	0.346	0.275	0.228	0.194	0.169	0.149	0.122	0.103	0.089	0.078	0.070	0.063	13.2
	3.0		<i>0.976</i>	<i>0.238</i>	0.785	0.645	0.534	0.451	0.389	0.342	0.304	0.250	0.212	0.184	0.163	0.146	0.132	
75 x 35	3.0	Semi-compact	1.92	0.410	1.66	1.38	1.15	0.964	0.829	0.725	0.645	0.527	0.446	0.387	0.342	0.306	0.278	29.7
	4.0	Plastic	<i>2.86</i>	<i>0.633</i>	2.50	2.13	1.81	1.55	1.35	1.19	1.07	0.878	0.747	0.650	0.575	0.516	0.468	39.6
	5.0	Plastic	<i>3.31</i>	<i>0.764</i>	3.06	2.72	2.40	2.12	1.88	1.68	1.52	1.26	1.08	0.945	0.839	0.754	0.685	49.5
100 x 50	3.0	Slender	3.36	0.513	3.21	2.84	2.45	2.08	1.79	1.56	1.37	1.11	0.937	0.809	0.713	0.637	0.577	39.6
	4.0	Slender	4.77	1.06	4.54	4.07	3.59	3.15	2.77	2.46	2.20	1.82	1.55	1.35	1.19	1.07	0.973	52.8
	5.0	Compact	<i>6.87</i>	<i>1.62</i>	6.45	5.79	5.14	4.55	4.03	3.60	3.25	2.70	2.31	2.02	1.79	1.61	1.46	66.0
125 x 50	3.0	Slender	4.59	0.524	4.34	3.76	3.12	2.56	2.14	1.82	1.59	1.26	1.05	0.897	0.785	0.699	0.631	49.5
	4.0	Slender	6.50	1.09	6.11	5.34	4.53	3.83	3.28	2.86	2.53	2.05	1.73	1.49	1.32	1.18	1.07	66.0
	5.0	Compact	<i>9.41</i>	<i>1.69</i>	8.75	7.60	6.48	5.52	4.77	4.19	3.72	3.05	2.58	2.24	1.98	1.77	1.61	82.5
	6.0	Plastic	<i>10.8</i>	<i>1.98</i>	10.2	9.12	8.02	7.03	6.20	5.51	4.96	4.11	3.51	3.06	2.71	2.43	2.21	99.0
150 x 60	4.0	Slender	9.02	1.18	8.84	7.98	6.98	5.99	5.12	4.43	3.89	3.12	2.60	2.23	1.96	1.75	1.58	79.2
	5.0	Semi-compact	11.7	2.06	11.4	10.4	9.18	8.03	7.01	6.17	5.50	4.49	3.80	3.29	2.90	2.60	2.35	99.0
	6.0	Compact	<i>16.3</i>	<i>2.91</i>	15.8	14.1	12.5	10.9	9.54	8.44	7.54	6.21	5.27	4.58	4.05	3.63	3.29	118
	8.0	Plastic	<i>20.0</i>	<i>3.74</i>	20.0	18.4	16.8	15.3	13.9	12.6	11.5	9.73	8.40	7.37	6.57	5.92	5.39	158
175 x 60	5.0	Semi-compact	14.6	2.11	14.2	12.7	11.0	9.42	8.07	7.00	6.16	4.96	4.15	3.57	3.14	2.80	2.53	115
	6.0	Compact	<i>20.3</i>	<i>2.98</i>	19.7	17.4	14.9	12.7	10.9	9.52	8.42	6.84	5.76	4.98	4.38	3.92	3.55	138
	8.0	Plastic	<i>25.2</i>	<i>3.83</i>	25.1	22.7	20.3	18.1	16.1	14.4	13.0	10.8	9.24	8.07	7.16	6.43	5.84	184
	10.0	Plastic	<i>29.2</i>	<i>4.62</i>	29.2	27.6	25.4	23.3	21.3	19.4	17.8	15.2	13.1	11.6	10.3	9.32	8.49	231
200 x 75	5.0	Slender	19.3	2.32	19.3	18.2	16.6	14.8	13.0	11.3	9.99	7.98	6.62	5.65	4.94	4.39	3.95	132
	6.0	Slender	24.0	3.73	24.0	22.5	20.5	18.5	16.4	14.5	13.0	10.6	8.89	7.67	6.75	6.03	5.45	158
	8.0	Plastic	<i>36.6</i>	<i>6.08</i>	36.6	34.2	31.2	28.2	25.2	22.7	20.5	17.0	14.5	12.6	11.2	10.1	9.13	211
	10.0	Plastic	<i>43.0</i>	<i>7.38</i>	43.0	41.4	38.5	35.6	32.7	30.1	27.7	23.7	20.5	18.1	16.2	14.6	13.3	264
225 x 75	6.0	Slender	28.4	3.78	28.4	26.4	24.0	21.3	18.6	16.3	14.4	11.5	9.62	8.25	7.22	6.43	5.80	178
	8.0	Plastic	<i>43.4</i>	<i>6.18</i>	43.4	40.5	36.5	32.4	28.6	25.3	22.6	18.5	15.7	13.6	12.0	10.7	9.72	237
	10.0	Plastic	<i>51.3</i>	<i>7.51</i>	51.3	49.1	45.1	41.1	37.3	33.8	30.8	25.9	22.3	19.5	17.4	15.6	14.2	297
	12.0	Plastic	<i>58.0</i>	<i>8.77</i>	58.0	57.1	53.3	49.5	45.8	42.3	39.2	33.7	29.4	26.0	23.3	21.0	19.2	356
250 x 100	6.0	Slender	36.7	4.19	36.7	36.7	34.7	32.5	30.1	27.5	25.0	20.5	17.1	14.6	12.7	11.2	10.1	198
	8.0	Slender	52.0	8.75	52.0	51.6	48.8	45.9	42.7	39.4	36.3	30.7	26.3	22.9	20.2	18.1	16.4	264
	10.0	Compact	<i>75.3</i>	<i>13.5</i>	75.3	74.3	70.0	65.5	60.8	56.2	51.8	44.2	38.2	33.5	29.8	26.8	24.4	330
	12.0	Plastic	<i>86.2</i>	<i>15.8</i>	86.2	86.2	82.0	77.5	73.0	68.5	64.1	56.2	49.6	44.1	39.6	36.0	32.9	396
300 x 100	8.0	Slender	67.3	8.97	67.3	66.5	62.6	58.3	53.6	48.8	44.1	36.3	30.4	26.1	22.8	20.3	18.3	316
	10.0	Compact	<i>97.8</i>	<i>13.8</i>	97.8	97.0	90.6	83.6	76.3	69.2	62.6	51.9	43.9	38.0	33.5	30.0	27.1	396
	12.0	Plastic	<i>112</i>	<i>16.3</i>	112	112	106	99.2	91.9	84.8	78.0	66.4	57.4	50.3	44.8	40.3	36.7	475
	15.0	Plastic	<i>131</i>	<i>19.7</i>	131	131	128	121	114	107	101	89.0	78.8	70.3	63.3	57.5	52.6	594
350 x 125	8.0	Slender	91.2	9.72	91.2	91.2	89.8	85.7	81.2	76.2	70.9	60.2	50.8	43.4	37.7	33.2	29.7	369
	10.0	Slender	119	17.4	119	119	116	111	105	99.2	92.7	80.0	68.9	59.9	52.8	47.1	42.5	462
	12.0	Compact	<i>167</i>	<i>25.8</i>	167	167	163	154	145	135	126	108	93.4	81.5	72.2	64.7	58.6	554
	15.0	Plastic	<i>198</i>	<i>31.4</i>	198	198	197	188	178	169	159	141	125	111	100	91.3	83.5	693
400 x 150	8.0	Slender	117	10.7	117	117	117	115	111	106	101	90.1	78.3	67.6	58.7	51.5	45.7	422
	10.0	Slender	154	18.5	154	154	154	151	145	139	132	118	103	90.7	79.9	71.0	63.8	528
	12.0	Slender	192	29.8	192	192	192	187	179	172	164	147	131	116	103	93.2	84.5	633
	15.0	Compact	<i>278</i>	<i>45.9</i>	278	278	278	269	258	246	234	210	186	166	149	135	123	792

Section classification applies to bending about both the x-x and y-y axis.

Moment capacity values in *italic type* are governed by $1.2p_y Z$ and a higher value may be used in some circumstances.

M_b is obtained using an equivalent slenderness = $uv\lambda(\beta_w^{0.5})$.

In certain cases, M_b may be greater than M_{cx} , which implies that lateral torsional buckling is not critical.

For explanation of table see Section 8.6.

Table 52

BENDING

**DOUBLE CHANNELS BACK TO BACK
SUBJECT TO BENDING**

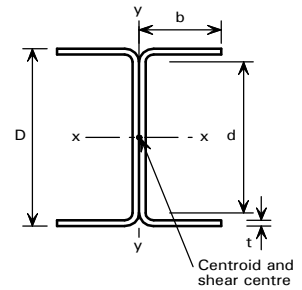

MOMENT CAPACITY AND BUCKLING RESISTANCE MOMENT FOR GRADE 1.4401 (316) and 1.4404 (316L)

D x 2b mm	t mm	Section Classification	Moment Capacity		Buckling Resistance Moment, M_b (kNm)														Shear Capacity P_v kN
			M_{cx} kNm	M_{cy} kNm	for Effective lengths, L_E (m)														
					1.0	1.5	2.0	2.5	3.0	3.5	4.0	5.0	6.0	7.0	8.0	9.0	10.0		
50 x 50	2.0	Slender	1.16	0.345	0.925	0.733	0.602	0.511	0.444	0.393	0.353	0.294	0.252	0.221	0.197	0.178	0.162	26.4	
	3.0	Compact	<i>1.95</i>	<i>0.670</i>	1.63	1.36	1.17	1.02	0.903	0.811	0.736	0.622	0.538	0.475	0.426	0.386	0.353	39.6	
75 x 70	3.0	Slender	3.80	1.06	3.46	2.85	2.40	2.07	1.81	1.61	1.45	1.22	1.05	0.922	0.824	0.745	0.681	59.4	
	4.0	Compact	5.72	1.75	5.22	4.41	3.80	3.33	2.97	2.67	2.43	2.06	1.79	1.58	1.42	1.29	1.18	79.2	
	5.0	Plastic	6.62	2.21	6.42	5.62	5.00	4.49	4.08	3.73	3.43	2.96	2.60	2.32	2.10	1.91	1.76	99.0	
100 x 100	3.0	Slender	6.58	1.72	6.58	5.96	5.16	4.48	3.92	3.47	3.10	2.56	2.19	1.91	1.70	1.53	1.40	79.2	
	4.0	Slender	9.28	2.76	9.28	8.42	7.40	6.56	5.86	5.29	4.82	4.09	3.55	3.15	2.82	2.56	2.35	105	
	5.0	Semi-compact	11.4	3.70	11.4	10.6	9.52	8.61	7.86	7.21	6.67	5.78	5.10	4.57	4.14	3.78	3.48	132	
125 x 100	3.0	Slender	9.01	1.71	9.01	7.76	6.52	5.49	4.67	4.04	3.55	2.85	2.38	2.05	1.81	1.62	1.46	99.0	
	4.0	Slender	12.7	2.76	12.7	10.9	9.26	7.95	6.92	6.10	5.46	4.51	3.85	3.37	2.99	2.70	2.46	132	
	5.0	Semi-compact	15.7	3.71	15.7	13.7	11.9	10.5	9.30	8.36	7.59	6.41	5.56	4.91	4.40	3.99	3.66	165	
	6.0	Compact	21.5	5.38	21.8	18.7	16.3	14.4	12.9	11.6	10.6	9.03	7.86	6.97	6.26	5.69	5.21	198	
150 x 120	4.0	Slender	17.7	3.52	17.7	16.5	14.3	12.4	10.8	9.53	8.46	6.89	5.81	5.03	4.44	3.98	3.62	158	
	5.0	Slender	23.0	5.11	23.0	21.4	18.7	16.4	14.5	12.9	11.6	9.71	8.33	7.30	6.51	5.88	5.37	198	
	6.0	Semi-compact	27.1	6.42	27.1	25.5	22.6	20.1	18.1	16.4	15.0	12.7	11.1	9.82	8.83	8.02	7.36	237	
	8.0	Plastic	40.0	10.4	41.3	38.3	34.3	31.1	28.3	26.0	24.0	20.8	18.4	16.4	14.9	13.6	12.5	316	
175 x 120	5.0	Slender	28.6	5.11	28.6	25.9	22.3	19.2	16.7	14.7	13.1	10.7	9.04	7.86	6.96	6.25	5.69	231	
	6.0	Semi-compact	33.8	6.43	33.8	30.9	26.9	23.6	20.8	18.6	16.8	14.0	12.1	10.6	9.45	8.55	7.81	277	
	8.0	Plastic	50.3	10.4	52.3	46.7	41.0	36.4	32.7	29.6	27.0	23.0	20.0	17.8	16.0	14.5	13.3	369	
	10.0	Plastic	58.3	13.2	61.8	57.1	51.4	46.8	42.9	39.5	36.7	32.0	28.4	25.5	23.1	21.2	19.5	462	
200 x 150	5.0	Slender	37.8	6.87	37.8	37.8	34.0	30.2	26.8	23.8	21.3	17.4	14.6	12.6	11.0	9.86	8.92	264	
	6.0	Slender	46.9	9.31	46.9	46.9	41.9	37.4	33.4	30.0	27.0	22.5	19.2	16.7	14.9	13.4	12.2	316	
	8.0	Compact	73.2	16.1	74.5	72.2	64.4	57.5	51.7	46.8	42.6	36.1	31.3	27.7	24.8	22.5	20.6	422	
	10.0	Plastic	86.0	20.3	88.9	87.6	79.3	72.2	66.2	61.0	56.5	49.2	43.6	39.1	35.5	32.5	29.9	528	
225 x 150	6.0	Slender	55.5	9.32	55.5	54.8	48.5	42.9	37.9	33.7	30.1	24.6	20.7	17.9	15.8	14.2	12.8	356	
	8.0	Compact	86.8	16.1	89.0	84.7	74.6	65.9	58.4	52.3	47.1	39.3	33.7	29.6	26.4	23.8	21.7	475	
	10.0	Plastic	102	20.3	106	102	92.0	82.8	75.0	68.4	62.8	53.9	47.2	42.0	37.8	34.5	31.7	594	
	12.0	Plastic	115	24.7	122	120	108	99.7	91.8	85.0	79.1	69.4	61.8	55.6	50.6	46.4	42.9	712	
250 x 200	6.0	Slender	72.1	13.7	72.1	72.1	72.1	67.6	62.1	57.0	52.2	43.9	37.4	32.3	28.4	25.3	22.8	396	
	8.0	Slender	101	22.1	101	101	101	94.3	87.0	80.2	74.1	63.6	55.3	48.8	43.7	39.5	36.1	528	
	10.0	Semi-compact	125	29.7	125	125	125	117	109	102	95.3	83.7	74.4	66.9	60.7	55.6	51.3	660	
	12.0	Compact	172	43.0	176	176	174	161	149	139	130	115	103	93.2	84.9	78.1	72.2	792	
300 x 200	8.0	Slender	131	22.1	131	131	129	118	108	98.6	89.9	75.3	64.2	55.7	49.2	44.0	39.8	633	
	10.0	Semi-compact	163	29.8	163	163	161	148	136	125	115	99.0	86.3	76.3	68.4	62.0	56.7	792	
	12.0	Compact	225	43.2	232	232	222	203	186	171	158	136	119	106	95.5	86.9	79.8	950	
	15.0	Plastic	263	54.6	276	276	269	249	231	216	202	179	161	145	133	122	113	1190	
350 x 250	8.0	Slender	178	29.7	178	178	178	178	167	155	144	124	107	93.6	82.3	73.2	65.8	739	
	10.0	Slender	232	43.1	232	232	232	231	216	201	187	163	142	125	111	100	91.7	924	
	12.0	Semi-compact	279	55.7	279	279	279	277	260	243	228	200	177	159	143	130	120	1110	
	15.0	Compact	397	84.2	408	408	408	395	369	346	324	287	256	231	210	192	178	1390	
400 x 300	8.0	Slender	231	38.3	231	231	231	231	231	222	209	186	164	145	128	114	102	844	
	10.0	Slender	302	54.9	302	302	302	302	302	287	271	241	214	190	170	153	138	1060	
	12.0	Slender	374	74.5	374	374	374	374	374	354	335	299	267	239	216	196	179	1270	
	15.0	Semi-compact	464	100	464	464	464	464	464	442	419	379	343	313	286	264	244	1580	

Section classification applies to bending about both the x-x and y-y axis.

Moment capacity values in *italic type* are governed by $1.2p_y Z$ and a higher value may be used in some circumstances.

M_b is obtained using an equivalent slenderness $= \nu \lambda (\beta_w^{0.5})$.

In certain cases, M_b may be greater than M_{cx} , which implies that lateral torsional buckling is not critical.

For explanation of table see Section 8.6.

[Blank Page]

E. MEMBER CAPACITIES

GRADE 1.4362 (SAF 2304)

Note: Sections in duplex stainless steel grade 1.4362 (SAF 2304) are less widely available on an ex-stock supply basis. Before proceeding with designs it is advisable to check availability with suppliers.

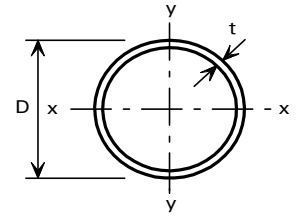
Table 53**COMPRESSION****CIRCULAR HOLLOW SECTIONS
SUBJECT TO AXIAL COMPRESSION****COMPRESSION RESISTANCE FOR GRADE 1.4362 (SAF 2304)**

D mm	t mm	Mass per Metre kg	Compression Resistance P_c (kN)												
			for Effective Length L_e (m)												
			1.0	1.5	2.0	2.5	3.0	3.5	4.0	5.0	6.0	7.0	8.0	9.0	10.0
21.3	1.0	0.50	5.21	2.49	1.45	0.950	0.669	0.497	0.383	0.248	0.174	0.128	0.099	0.078	0.063
	1.2	0.60	6.09	2.91	1.70	1.11	0.781	0.580	0.447	0.289	0.203	0.150	0.115	0.091	0.074
	1.6	0.78	7.70	3.68	2.14	1.40	0.985	0.731	0.564	0.365	0.255	0.188	0.145	0.115	0.093
	2.0	0.96	9.12	4.35	2.53	1.65	1.16	0.864	0.666	0.431	0.301	0.223	0.171	0.136	0.110
	2.3	1.08	10.1	4.80	2.79	1.82	1.28	0.952	0.734	0.475	0.332	0.245	0.188	0.149	0.121
33.7	1.0	0.81	18.3	9.49	5.68	3.77	2.68	2.00	1.55	1.01	0.708	0.525	0.404	0.321	0.261
	1.6	1.27	28.0	14.5	8.64	5.72	4.06	3.03	2.35	1.53	1.07	0.796	0.613	0.487	0.396
	2.0	1.57	33.9	17.5	10.4	6.91	4.91	3.66	2.84	1.85	1.30	0.961	0.740	0.588	0.478
	2.5	1.94	40.9	21.0	12.5	8.27	5.87	4.38	3.39	2.21	1.55	1.15	0.885	0.702	0.571
	3.2	2.42	49.6	25.3	15.1	9.96	7.07	5.27	4.08	2.66	1.86	1.38	1.06	0.844	0.687
42.4	1.0	1.03	31.4	17.8	11.0	7.36	5.27	3.95	3.07	2.01	1.41	1.05	0.811	0.645	0.525
	1.6	1.62	48.8	27.5	16.9	11.3	8.09	6.06	4.71	3.08	2.17	1.61	1.24	0.989	0.805
	2.0	2.01	59.7	33.5	20.6	13.8	9.84	7.38	5.73	3.75	2.64	1.96	1.51	1.20	0.978
	2.6	2.57	75.3	42.0	25.7	17.2	12.3	9.20	7.15	4.67	3.29	2.44	1.88	1.50	1.22
	3.2	3.11	89.7	49.7	30.4	20.3	14.5	10.9	8.44	5.51	3.88	2.88	2.22	1.77	1.44
48.3	1.0	1.17	41.2	25.1	15.8	10.7	7.69	5.79	4.51	2.96	2.09	1.55	1.20	0.954	0.777
	1.6	1.85	64.3	38.9	24.4	16.5	11.9	8.93	6.96	4.56	3.22	2.39	1.85	1.47	1.20
	2.0	2.30	79.1	47.6	29.8	20.2	14.5	10.9	8.49	5.57	3.93	2.92	2.26	1.79	1.46
	2.6	2.95	100	59.9	37.5	25.3	18.2	13.7	10.6	6.98	4.92	3.66	2.83	2.25	1.83
	3.2	3.58	120	71.4	44.6	30.1	21.6	16.2	12.6	8.28	5.84	4.34	3.35	2.67	2.17
60.3	1.6	2.33	96.2	66.8	44.6	31.0	22.5	17.1	13.4	8.84	6.26	4.67	3.61	2.88	2.35
	2.0	2.89	118	82.2	54.8	38.0	27.7	21.0	16.4	10.8	7.68	5.72	4.43	3.53	2.88
	2.6	3.72	152	104	69.4	48.1	35.0	26.5	20.7	13.7	9.69	7.22	5.59	4.46	3.63
	3.2	4.53	184	125	83.3	57.6	41.8	31.7	24.8	16.4	11.6	8.63	6.68	5.32	4.34
	4.0	5.59	224	152	100	69.4	50.4	38.1	29.8	19.7	13.9	10.4	8.03	6.40	5.22
5.0	6.86	273	183	120	82.8	60.1	45.4	35.5	23.4	16.6	12.3	9.55	7.61	6.20	
76.1	1.6	2.96	136	108	79.7	58.0	43.2	33.2	26.2	17.5	12.5	9.32	7.23	5.78	4.72
	2.0	3.68	169	134	98.4	71.5	53.2	40.9	32.3	21.5	15.3	11.5	8.91	7.11	5.81
	2.6	4.74	218	171	125	91.0	67.7	52.0	41.0	27.3	19.5	14.6	11.3	9.03	7.38
	3.2	5.79	265	208	151	109	81.6	62.6	49.4	32.9	23.4	17.5	13.6	10.9	8.87
	4.0	7.16	327	255	184	133	99.1	76.0	59.9	39.9	28.4	21.2	16.5	13.2	10.8
5.0	8.82	401	310	224	161	119	91.5	72.1	48.0	34.2	25.6	19.8	15.8	12.9	
88.9	2.0	4.31	210	176	139	105	80.9	63.0	50.1	33.7	24.2	18.2	14.1	11.3	9.25
	2.6	5.57	270	226	178	135	103	80.4	64.0	43.0	30.8	23.1	18.0	14.4	11.8
	3.2	6.81	330	276	216	164	124	97.1	77.3	51.9	37.2	27.9	21.7	17.4	14.2
	4.0	8.43	407	340	265	200	152	118	94.2	63.3	45.3	34.0	26.5	21.2	17.3
	5.0	10.4	502	417	323	243	185	143	114	76.6	54.8	41.1	32.0	25.6	20.9
101.6	2.6	6.39	322	280	233	185	145	115	92.8	63.1	45.5	34.3	26.7	21.4	17.6
	3.2	7.81	393	342	283	225	176	139	112	76.4	55.0	41.5	32.3	25.9	21.2
	4.0	9.69	487	423	349	276	216	171	137	93.4	67.3	50.7	39.5	31.7	25.9
	5.0	12.0	601	520	428	338	264	208	167	113	81.7	61.6	48.0	38.5	31.5
114.3	2.6	7.21	364	333	288	239	193	156	127	87.9	63.8	48.3	37.7	30.3	24.9
	3.2	8.82	446	407	351	291	235	190	154	106	77.4	58.5	45.8	36.7	30.2
	4.0	10.9	554	504	434	359	290	233	189	130	94.8	71.7	56.1	45.0	36.9
	5.0	13.6	686	622	534	440	355	285	232	159	115	87.4	68.3	54.9	45.0

Only the sections which are non slender under axial compression are given in the table.

For explanation of table see Section 8.4.

COMPRESSION

CIRCULAR HOLLOW SECTIONS SUBJECT TO AXIAL COMPRESSION

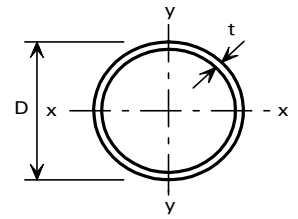

COMPRESSION RESISTANCE FOR GRADE 1.4362 (SAF 2304)

D mm	t mm	Mass per Metre kg	Compression Resistance P_c (kN)												
			for Effective Length L_e (m)												
			2.0	3.0	4.0	5.0	6.0	7.0	8.0	9.0	10.0	11.0	12.0	13.0	14.0
139.7	3.2	10.8	483	366	259	184	136	104	82.0	66.1	54.4	45.6	38.7	33.3	28.9
	4.0	13.5	599	452	319	227	167	128	100	81.3	66.9	56.0	47.6	40.9	35.6
	5.0	16.7	741	558	392	279	205	157	123	99.6	82.0	68.6	58.3	50.1	43.5
168.3	4.0	16.3	781	643	494	369	279	216	171	139	115	96.8	82.4	71.0	61.8
	5.0	20.3	968	796	610	455	344	266	211	171	141	118	101	87.2	75.9
219.1	5.0	26.6	1350	1210	1030	844	676	541	438	360	301	254	217	188	164

Only the sections which are non slender under axial compression are given in the table.

For explanation of table see Section 8.4.

Table 54

COMPRESSION

**RECTANGULAR HOLLOW SECTIONS
SUBJECT TO AXIAL COMPRESSION**

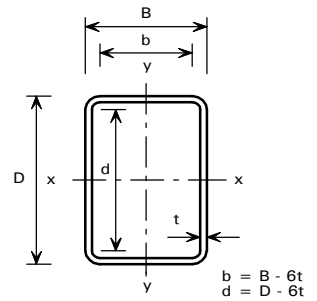

COMPRESSION RESISTANCE FOR GRADE 1.4362 (SAF 2304)

D x B mm	t mm	Mass per Metre kg	Axis	Compression Resistance, P_{cx} , P_{cy} (kN)												
				for Effective Length L_E (m)												
				1.0	1.5	2.0	2.5	3.0	3.5	4.0	5.0	6.0	7.0	8.0	9.0	10.0
50 x 25	* 1.5	1.63	P_{cx}	57.5	36.8	23.7	16.2	11.7	8.81	6.87	4.52	3.20	2.38	1.84	1.46	1.19
			P_{cy}	30.4	15.4	9.19	6.07	4.31	3.21	2.49	1.62	1.13	0.840	0.647	0.514	0.418
	2.0	2.11	P_{cx}	76.0	47.1	29.9	20.3	14.6	11.0	8.58	5.64	3.98	2.96	2.29	1.82	1.48
			P_{cy}	38.4	19.3	11.4	7.53	5.33	3.97	3.08	2.00	1.40	1.04	0.799	0.634	0.515
60 x 30	* 2.0	2.58	P_{cx}	106	74.5	50.1	34.9	25.4	19.3	15.1	9.99	7.08	5.28	4.09	3.26	2.66
			P_{cy}	62.9	33.3	20.1	13.4	9.50	7.10	5.51	3.59	2.53	1.87	1.44	1.15	0.932
	3.0	3.68	P_{cx}	149	102	67.7	46.8	34.0	25.8	20.2	13.3	9.42	7.02	5.43	4.33	3.53
			P_{cy}	84.9	44.3	26.6	17.6	12.5	9.35	7.25	4.72	3.32	2.46	1.89	1.50	1.22
80 x 40	* 2.0	3.53	P_{cx}	147	123	97.7	74.4	56.8	44.2	35.2	23.7	17.0	12.8	9.93	7.94	6.50
			P_{cy}	113	72.0	46.1	31.5	22.7	17.1	13.4	8.78	6.21	4.62	3.57	2.84	2.32
	3.0	5.10	P_{cx}	240	194	146	108	81.2	62.6	49.6	33.1	23.7	17.7	13.8	11.0	9.00
			P_{cy}	173	103	64.9	43.8	31.5	23.7	18.4	12.1	8.52	6.33	4.89	3.89	3.17
	4.0	6.54	P_{cx}	305	244	181	132	99.4	76.5	60.5	40.4	28.8	21.6	16.7	13.4	10.9
			P_{cy}	215	126	78.7	53.1	38.0	28.6	22.2	14.6	10.3	7.64	5.90	4.69	3.82
100 x 50	* 2.0	4.48	P_{cx}	174	161	141	118	97.2	79.0	64.6	44.8	32.6	24.7	19.3	15.5	12.7
			P_{cy}	153	116	82.1	58.5	43.1	32.9	25.9	17.2	12.2	9.14	7.08	5.65	4.62
	* 3.0	6.52	P_{cx}	308	273	229	185	147	117	94.6	64.6	46.7	35.2	27.5	22.1	18.1
			P_{cy}	255	180	121	84.7	61.8	46.9	36.8	24.3	17.2	12.8	9.94	7.93	6.47
	4.0	8.43	P_{cx}	423	368	304	240	188	148	119	81.2	58.5	44.0	34.3	27.5	22.5
			P_{cy}	341	232	153	106	77.1	58.4	45.7	30.1	21.3	15.9	12.3	9.80	7.99
	5.0	10.2	P_{cx}	510	440	361	283	220	173	139	94.5	68.0	51.2	39.9	31.9	26.2
			P_{cy}	406	272	178	123	89.2	67.5	52.8	34.8	24.6	18.3	14.2	11.3	9.21
	6.0	11.9	P_{cx}	589	505	410	319	247	194	155	105	75.5	56.8	44.3	35.4	29.0
			P_{cy}	463	305	198	136	98.8	74.6	58.3	38.4	27.2	20.2	15.6	12.5	10.2
150 x 75	* 3.0	10.1	P_{cx}	393	393	378	349	317	284	250	190	145	113	90.1	73.3	60.7
			P_{cy}	393	346	290	233	184	146	118	80.8	58.3	44.0	34.3	27.5	22.6
	* 4.0	13.2	P_{cx}	589	589	552	504	450	395	342	254	191	147	117	94.9	78.4
			P_{cy}	579	497	404	316	245	192	154	104	75.0	56.4	44.0	35.2	28.8
	* 5.0	16.1	P_{cx}	803	801	735	662	583	503	429	313	233	179	141	114	94.5
			P_{cy}	774	652	515	393	300	234	186	125	90.0	67.6	52.6	42.1	34.4
	6.0	19.0	P_{cx}	960	953	872	781	684	587	499	361	268	206	162	131	108
			P_{cy}	919	767	600	454	345	268	213	143	102	77.1	60.0	48.0	39.3
	8.0	24.2	P_{cx}	1230	1210	1100	980	851	725	612	440	326	249	197	159	131
			P_{cy}	1160	958	738	552	418	323	257	172	123	92.4	71.9	57.5	47.0
150 x 100	* 3.0	11.3	P_{cx}	431	431	421	392	359	325	289	224	173	135	108	88.2	73.1
			P_{cy}	431	419	378	331	283	238	199	141	104	79.7	62.7	50.5	41.6
	* 4.0	14.8	P_{cx}	669	669	635	583	525	465	406	305	231	179	142	115	95.5
			P_{cy}	669	631	557	476	396	325	268	187	136	103	81.5	65.6	53.9
	* 5.0	18.1	P_{cx}	903	903	841	764	680	594	512	377	283	218	173	140	115
			P_{cy}	903	834	726	609	497	404	330	228	166	125	98.5	79.1	65.0
	6.0	21.3	P_{cx}	1080	1080	999	904	801	696	598	438	328	252	200	161	133
			P_{cy}	1080	990	857	714	580	469	382	263	191	145	113	91.1	74.8
	8.0	27.4	P_{cx}	1390	1390	1270	1150	1010	871	744	542	404	310	245	198	163
			P_{cy}	1390	1260	1080	892	719	579	470	323	234	177	138	111	91.3

* Section is slender under axial compression and allowance has been made in calculating the compression resistance.

For explanation of table see Section 8.4.

Table 54

COMPRESSION

**RECTANGULAR HOLLOW SECTIONS
SUBJECT TO AXIAL COMPRESSION**

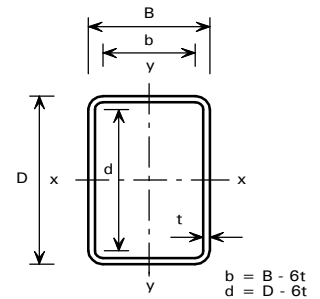

COMPRESSION RESISTANCE FOR GRADE 1.4362 (SAF 2304)

D x B mm	t mm	Mass per Metre kg	Axis	Compression Resistance, P_{cx} , P_{cy} (kN)												
				for Effective Length L_E (m)												
				1.0	1.5	2.0	2.5	3.0	3.5	4.0	5.0	6.0	7.0	8.0	9.0	10.0
200 x 100	* 4.0	17.9	P_{cx}	699	699	699	684	647	607	564	474	388	316	258	213	179
			P_{cy}	699	680	615	541	464	391	328	233	172	131	103	83.6	68.8
	* 5.0	22.1	P_{cx}	957	957	957	921	865	805	742	610	491	394	320	263	220
			P_{cy}	957	915	816	706	595	494	409	288	211	160	126	101	83.5
	* 6.0	26.1	P_{cx}	1230	1230	1230	1170	1090	1010	919	742	589	469	378	310	258
			P_{cy}	1230	1160	1020	870	721	591	486	338	247	187	147	118	97.1
	8.0	33.7	P_{cx}	1710	1710	1700	1590	1470	1350	1220	963	753	595	478	390	324
			P_{cy}	1710	1570	1360	1140	929	752	614	424	308	233	182	146	120
	10.0	40.8	P_{cx}	2070	2070	2040	1910	1760	1610	1440	1130	883	695	557	455	377
			P_{cy}	2070	1890	1630	1350	1090	878	714	492	356	269	211	169	139
200 x 125	* 4.0	19.5	P_{cx}	759	759	759	750	712	670	626	532	440	360	296	245	206
			P_{cy}	759	759	722	664	599	531	464	349	265	205	163	132	109
	* 5.0	24.0	P_{cx}	1060	1060	1060	1030	966	903	835	694	562	454	370	305	255
			P_{cy}	1060	1060	983	892	793	692	596	439	329	253	200	162	134
	* 6.0	28.5	P_{cx}	1350	1350	1350	1300	1220	1130	1030	845	676	541	438	360	300
			P_{cy}	1350	1350	1240	1110	977	842	717	521	388	298	235	190	157
	8.0	36.9	P_{cx}	1870	1870	1870	1760	1640	1510	1370	1100	871	691	557	456	380
			P_{cy}	1870	1840	1670	1490	1290	1100	925	664	491	376	296	239	197
	10.0	44.8	P_{cx}	2270	2270	2260	2120	1970	1810	1640	1310	1030	815	655	536	446
			P_{cy}	2270	2220	2010	1780	1530	1300	1090	780	576	440	346	279	230
250 x 125	* 6.0	33.2	P_{cx}	1410	1410	1410	1410	1380	1320	1250	1100	950	803	674	568	481
			P_{cy}	1410	1410	1330	1210	1090	954	827	615	463	358	284	230	190
	* 8.0	43.2	P_{cx}	2110	2110	2110	2110	2010	1910	1790	1550	1300	1080	891	743	626
			P_{cy}	2110	2100	1920	1730	1510	1300	1110	805	599	460	363	293	242
	10.0	52.7	P_{cx}	2670	2670	2670	2650	2520	2370	2220	1900	1580	1300	1070	888	746
			P_{cy}	2670	2630	2390	2130	1850	1580	1330	959	711	544	429	346	285
	12.0	61.7	P_{cx}	3120	3120	3120	3090	2930	2760	2580	2190	1810	1480	1220	1010	848
			P_{cy}	3120	3060	2780	2460	2130	1800	1520	1090	803	614	484	390	321
	15.0	74.1	P_{cx}	3750	3750	3750	3680	3480	3270	3040	2560	2100	1710	1400	1160	970
			P_{cy}	3750	3650	3290	2900	2480	2090	1750	1240	914	698	549	442	364
250 x 150	* 6.0	35.6	P_{cx}	1530	1530	1530	1530	1510	1440	1370	1220	1050	894	754	637	541
			P_{cy}	1530	1530	1510	1410	1300	1190	1070	837	651	512	410	335	278
	* 8.0	46.4	P_{cx}	2270	2270	2270	2270	2180	2070	1960	1700	1440	1200	1000	836	706
			P_{cy}	2270	2270	2190	2030	1850	1650	1460	1120	853	665	530	431	356
	10.0	56.6	P_{cx}	2870	2870	2870	2870	2730	2590	2430	2100	1760	1460	1210	1010	846
			P_{cy}	2870	2870	2740	2520	2280	2030	1780	1350	1020	794	631	513	424
	12.0	66.4	P_{cx}	3360	3360	3360	3350	3190	3010	2830	2430	2030	1670	1380	1150	966
			P_{cy}	3360	3360	3200	2930	2650	2350	2050	1540	1170	904	718	583	482
	15.0	80.1	P_{cx}	4050	4050	4050	4010	3810	3590	3360	2860	2370	1950	1600	1330	1120
			P_{cy}	4050	4050	3820	3490	3130	2760	2390	1780	1350	1040	825	669	553

* Section is slender under axial compression and allowance has been made in calculating the compression resistance.

For explanation of table see Section 8.4.

Table 54

COMPRESSION

**RECTANGULAR HOLLOW SECTIONS
SUBJECT TO AXIAL COMPRESSION**

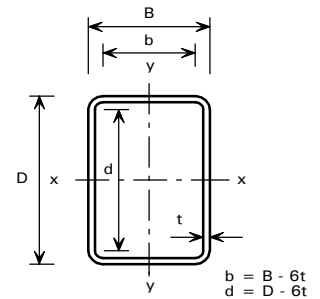

COMPRESSION RESISTANCE FOR GRADE 1.4362 (SAF 2304)

D x B mm	t mm	Mass per Metre kg	Axis	Compression Resistance, P_{cx} , P_{cy} (kN)												
				for Effective Length L_E (m)												
				2.0	3.0	4.0	5.0	6.0	7.0	8.0	9.0	10.0	11.0	12.0	13.0	14.0
300 x 150	* 6.0	40.3	P_{cx}	1570	1570	1510	1400	1270	1140	1000	874	761	664	581	511	452
			P_{cy}	1570	1380	1160	934	738	587	473	388	323	272	233	201	175
	* 8.0	52.7	P_{cx}	2360	2360	2210	2020	1800	1580	1370	1180	1020	879	765	670	591
			P_{cy}	2320	1990	1620	1260	980	770	616	502	417	351	299	258	225
	* 10.0	64.5	P_{cx}	3210	3210	2940	2650	2330	2010	1720	1470	1250	1080	934	815	717
			P_{cy}	3100	2610	2060	1570	1200	936	745	606	502	422	359	310	270
	12.0	75.9	P_{cx}	3840	3810	3490	3130	2740	2350	2000	1700	1450	1240	1080	938	825
			P_{cy}	3680	3070	2400	1820	1380	1070	854	693	574	482	411	354	308
	15.0	91.9	P_{cx}	4650	4590	4190	3730	3250	2770	2350	1990	1690	1450	1250	1090	960
			P_{cy}	4420	3660	2830	2120	1610	1250	989	802	663	557	474	409	356
300 x 200	* 6.0	45.0	P_{cx}	1730	1730	1690	1570	1440	1300	1160	1020	897	787	692	611	542
			P_{cy}	1730	1680	1510	1330	1140	954	798	670	567	484	417	363	318
	* 8.0	59.0	P_{cx}	2680	2680	2540	2330	2100	1860	1630	1410	1220	1060	924	811	716
			P_{cy}	2680	2530	2230	1910	1590	1300	1070	892	749	637	547	474	415
	* 10.0	72.4	P_{cx}	3610	3610	3370	3060	2720	2380	2050	1760	1510	1300	1130	992	874
			P_{cy}	3610	3340	2910	2440	1990	1620	1320	1090	914	774	664	575	503
	12.0	85.4	P_{cx}	4320	4320	4000	3620	3210	2790	2390	2050	1760	1510	1310	1150	1010
			P_{cy}	4320	3960	3430	2860	2320	1880	1530	1260	1060	894	766	663	580
	15.0	103	P_{cx}	5250	5250	4830	4350	3840	3320	2840	2420	2070	1790	1550	1350	1190
			P_{cy}	5250	4780	4110	3400	2750	2210	1800	1480	1240	1050	898	777	679
350 x 175	* 6.0	47.4	P_{cx}	1720	1720	1720	1640	1540	1420	1310	1180	1060	951	848	758	678
			P_{cy}	1720	1630	1450	1240	1040	857	708	589	495	421	362	314	275
	* 8.0	62.2	P_{cx}	2580	2580	2570	2400	2230	2040	1840	1640	1460	1290	1140	1010	901
			P_{cy}	2580	2380	2070	1740	1420	1150	938	775	649	550	471	408	357
	* 10.0	76.4	P_{cx}	3530	3530	3450	3210	2950	2660	2370	2090	1840	1610	1420	1250	1110
			P_{cy}	3530	3180	2710	2220	1780	1420	1150	948	791	668	572	495	432
	* 12.0	90.1	P_{cx}	4550	4550	4370	4030	3670	3280	2890	2520	2190	1910	1670	1470	1300
			P_{cy}	4550	3990	3340	2680	2110	1680	1350	1110	920	777	664	573	500
	15.0	109	P_{cx}	5550	5550	5310	4890	4420	3930	3450	3000	2610	2270	1980	1740	1540
			P_{cy}	5530	4820	4000	3180	2500	1970	1590	1300	1080	910	778	672	586
350 x 200	* 6.0	49.8	P_{cx}	1760	1760	1760	1690	1590	1480	1370	1250	1130	1010	907	813	729
			P_{cy}	1760	1730	1580	1410	1220	1040	881	745	634	543	470	409	360
	* 8.0	65.3	P_{cx}	2740	2740	2730	2570	2380	2190	1980	1770	1580	1400	1240	1100	980
			P_{cy}	2740	2630	2360	2050	1730	1440	1200	1000	844	719	619	538	471
	* 10.0	80.3	P_{cx}	3730	3730	3660	3420	3140	2850	2550	2260	1990	1750	1540	1360	1210
			P_{cy}	3730	3510	3100	2650	2200	1800	1480	1230	1040	879	755	655	573
	* 12.0	94.8	P_{cx}	4790	4790	4630	4290	3910	3510	3110	2730	2380	2080	1820	1610	1420
			P_{cy}	4790	4420	3850	3230	2640	2140	1750	1450	1210	1030	881	763	667
	15.0	115	P_{cx}	5850	5850	5630	5200	4730	4230	3730	3260	2840	2480	2170	1910	1690
			P_{cy}	5850	5370	4650	3870	3150	2540	2070	1710	1430	1210	1040	899	786

* Section is slender under axial compression and allowance has been made in calculating the compression resistance.

For explanation of table see Section 8.4.

Table 54

COMPRESSION

**RECTANGULAR HOLLOW SECTIONS
SUBJECT TO AXIAL COMPRESSION**

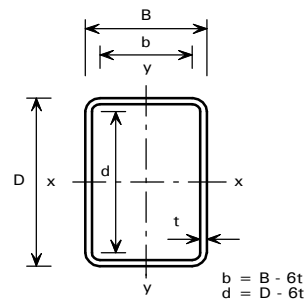

COMPRESSION RESISTANCE FOR GRADE 1.4362 (SAF 2304)

D x B mm	t mm	Mass per Metre kg	Axis	Compression Resistance, P_{cx} , P_{cy} (kN)												
				for Effective Length L_E (m)												
				2.0	3.0	4.0	5.0	6.0	7.0	8.0	9.0	10.0	11.0	12.0	13.0	14.0
400 x 200	* 6.0	54.5	P_{cx}	1780	1780	1780	1780	1700	1620	1520	1420	1320	1210	1110	1010	922
			P_{cy}	1780	1780	1630	1470	1300	1120	957	816	698	600	520	454	400
	* 8.0	71.6	P_{cx}	2800	2800	2800	2740	2590	2430	2260	2080	1900	1720	1560	1400	1260
			P_{cy}	2800	2720	2460	2170	1860	1570	1310	1100	935	799	689	600	526
	* 10.0	88.2	P_{cx}	3830	3830	3830	3690	3460	3220	2970	2700	2440	2190	1970	1760	1580
			P_{cy}	3830	3660	3270	2830	2380	1980	1640	1370	1150	981	844	733	642
	* 12.0	104	P_{cx}	4940	4940	4940	4680	4370	4030	3680	3320	2970	2650	2360	2100	1880
			P_{cy}	4940	4640	4090	3480	2880	2370	1940	1610	1360	1150	988	857	750
	15.0	127	P_{cx}	6450	6450	6420	6010	5580	5110	4620	4130	3660	3240	2870	2550	2270
			P_{cy}	6450	5950	5180	4340	3540	2870	2340	1940	1620	1370	1180	1020	892
400 x 250	* 6.0	59.3	P_{cx}	1840	1840	1840	1840	1790	1700	1620	1520	1420	1320	1220	1120	1030
			P_{cy}	1840	1840	1810	1690	1560	1420	1280	1130	999	880	776	687	610
	* 8.0	78.0	P_{cx}	3040	3040	3040	3000	2850	2680	2510	2320	2130	1940	1760	1590	1440
			P_{cy}	3040	3040	2890	2660	2400	2130	1860	1610	1400	1220	1060	931	822
	* 10.0	96.1	P_{cx}	4230	4230	4230	4100	3870	3610	3340	3060	2780	2500	2250	2020	1820
			P_{cy}	4230	4230	3930	3570	3170	2770	2390	2050	1760	1520	1320	1150	1020
	* 12.0	113	P_{cx}	5420	5420	5420	5190	4860	4510	4140	3760	3380	3030	2710	2420	2170
			P_{cy}	5420	5400	4950	4450	3910	3370	2870	2440	2090	1800	1560	1360	1190
	15.0	139	P_{cx}	7050	7050	7050	6660	6210	5720	5210	4690	4190	3730	3310	2950	2630
			P_{cy}	7050	6950	6330	5630	4890	4160	3520	2970	2530	2170	1870	1630	1430

* Section is slender under axial compression and allowance has been made in calculating the compression resistance.

For explanation of table see Section 8.4.

Table 55

COMPRESSION

**SQUARE HOLLOW SECTIONS
SUBJECT TO AXIAL COMPRESSION**

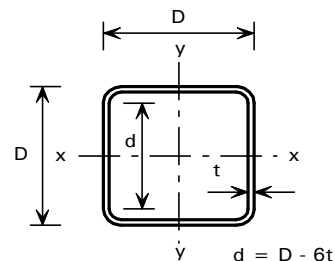

COMPRESSION RESISTANCE FOR GRADE 1.4362 (SAF 2304)

D x D mm	t mm	Mass per Metre kg	Compression Resistance P_c (kN)												
			for Effective Length L_e (m)												
			1.0	1.5	2.0	2.5	3.0	3.5	4.0	5.0	6.0	7.0	8.0	9.0	10.0
40 x 40	2.0	2.27	72.5	41.9	26.0	17.5	12.5	9.39	7.30	4.78	3.37	2.50	1.93	1.54	1.25
	3.0	3.20	98.0	55.6	34.2	22.9	16.4	12.3	9.57	6.26	4.41	3.27	2.53	2.01	1.64
50 x 50	2.0	2.90	114	75.8	49.5	34.1	24.7	18.7	14.6	9.61	6.80	5.06	3.92	3.12	2.54
	3.0	4.15	159	104	67.5	46.3	33.5	25.3	19.7	13.0	9.19	6.84	5.29	4.21	3.43
	4.0	5.27	198	126	81.3	55.5	40.0	30.2	23.6	15.5	11.0	8.16	6.30	5.02	4.09
60 x 60	* 2.0	3.53	152	114	80.4	57.1	42.0	32.1	25.2	16.7	11.9	8.89	6.89	5.50	4.49
	3.0	5.10	221	163	112	79.6	58.4	44.5	34.9	23.1	16.4	12.3	9.51	7.58	6.19
	4.0	6.54	280	203	139	97.7	71.5	54.4	42.7	28.2	20.0	15.0	11.6	9.24	7.54
	5.0	7.84	331	236	160	111	81.7	62.0	48.6	32.2	22.8	17.0	13.2	10.5	8.57
80 x 80	* 2.0	4.79	191	167	139	112	88.3	70.0	56.4	38.4	27.7	20.9	16.3	13.1	10.7
	3.0	6.99	341	288	228	174	133	103	82.7	55.7	39.9	30.0	23.3	18.7	15.3
	4.0	9.06	440	369	289	219	167	130	103	69.8	50.0	37.5	29.2	23.4	19.1
	5.0	11.0	531	442	344	259	197	153	121	81.8	58.6	43.9	34.2	27.3	22.4
100 x 100	* 3.0	8.89	407	378	330	278	228	186	152	105	76.8	58.2	45.6	36.7	30.1
	4.0	11.6	586	532	456	376	303	243	198	136	98.7	74.6	58.3	46.8	38.4
	5.0	14.2	717	646	552	452	363	291	236	162	117	88.7	69.3	55.6	45.6
	6.0	16.6	840	752	639	522	417	333	270	185	133	101	79.0	63.4	52.0
125 x 125	8.0	21.1	1070	942	792	639	506	402	325	221	160	120	94.3	75.7	62.0
	* 3.0	11.3	436	436	408	372	333	292	253	187	141	109	86.4	70.0	57.9
	* 4.0	14.8	707	697	634	565	490	418	353	254	188	144	113	91.7	75.5
	5.0	18.1	917	894	809	713	613	517	434	309	228	174	137	110	91.2
	6.0	21.3	1080	1050	948	833	714	600	503	357	263	201	158	127	105
150 x 150	8.0	27.4	1390	1340	1200	1050	894	747	623	441	324	247	194	156	128
	* 3.0	13.6	456	456	456	433	404	374	341	276	219	175	141	115	96.6
	* 4.0	17.9	752	752	734	683	627	567	506	392	302	237	189	154	128
	* 5.0	22.1	1090	1090	1040	952	860	763	667	502	381	295	234	190	157
	6.0	26.1	1320	1320	1250	1140	1030	906	789	589	445	345	273	222	183
8.0	33.7	1710	1710	1600	1460	1310	1150	997	740	558	431	341	277	228	

* Section is slender under axial compression and allowance has been made in calculating the compression resistance.

For explanation of table see Section 8.4.

Table 55

COMPRESSION

**SQUARE HOLLOW SECTIONS
SUBJECT TO AXIAL COMPRESSION**

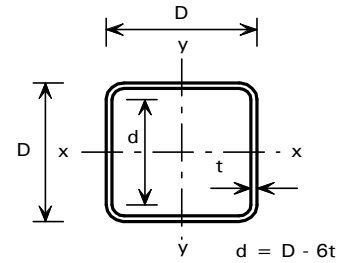

COMPRESSION RESISTANCE FOR GRADE 1.4362 (SAF 2304)

D x D mm	t mm	Mass per Metre kg	Compression Resistance P_c (kN)												
			for Effective Length L_e (m)												
			2.0	3.0	4.0	5.0	6.0	7.0	8.0	9.0	10.0	11.0	12.0	13.0	14.0
175 x 175	* 4.0	21.1	785	723	629	526	429	348	284	234	196	166	142	123	108
	* 5.0	26.0	1150	1020	863	699	556	443	358	293	244	206	176	152	133
	* 6.0	30.8	1540	1330	1100	865	676	533	427	349	290	244	209	180	157
	8.0	40.0	2000	1720	1410	1100	858	675	541	441	366	308	263	227	198
	10.0	48.7	2420	2080	1690	1310	1020	798	639	521	432	364	310	268	233
200 x 200	* 4.0	24.2	811	793	719	636	548	464	390	329	279	238	206	179	157
	* 5.0	30.0	1200	1140	1010	874	733	607	502	418	352	299	257	224	196
	* 6.0	35.6	1630	1510	1320	1110	914	744	609	504	422	358	307	266	232
	8.0	46.4	2350	2130	1830	1510	1210	975	792	652	544	461	394	341	298
	10.0	56.6	2870	2580	2210	1810	1450	1170	945	777	648	548	469	406	354
250 x 250	* 5.0	37.9	1270	1270	1220	1120	1020	912	803	701	610	531	465	409	362
	* 6.0	45.0	1740	1740	1640	1490	1330	1170	1010	871	750	649	564	494	436
	* 8.0	59.0	2830	2790	2540	2260	1960	1670	1410	1200	1020	871	752	656	576
	10.0	72.4	3670	3580	3240	2850	2450	2070	1740	1460	1240	1060	913	795	697
	12.0	85.4	4320	4200	3790	3340	2860	2400	2010	1690	1430	1220	1050	917	805
300 x 300	* 5.0	45.8	1320	1320	1320	1280	1210	1130	1040	956	868	784	705	633	570
	* 6.0	54.5	1830	1830	1830	1730	1620	1500	1370	1230	1110	986	878	783	700
	* 8.0	71.6	3010	3010	2940	2730	2510	2270	2030	1790	1570	1380	1210	1070	949
	* 10.0	88.2	4360	4360	4150	3810	3440	3050	2670	2320	2010	1750	1520	1340	1180
	12.0	104	5280	5280	4990	4570	4110	3630	3160	2730	2360	2050	1780	1560	1380
350 x 350	* 6.0	64.0	1890	1890	1890	1890	1810	1720	1620	1520	1410	1300	1190	1090	994
	* 8.0	84.3	3140	3140	3140	3070	2900	2710	2520	2310	2110	1910	1720	1550	1390
	* 10.0	104	4600	4600	4600	4370	4090	3780	3450	3120	2800	2500	2220	1980	1770
	* 12.0	123	6210	6210	6150	5760	5330	4870	4390	3910	3460	3060	2700	2400	2130
	15.0	151	7650	7650	7550	7060	6520	5940	5340	4740	4190	3690	3260	2890	2570
400 x 400	* 6.0	73.5	1930	1930	1930	1930	1930	1880	1800	1720	1640	1550	1460	1370	1270
	* 8.0	96.9	3250	3250	3250	3250	3180	3030	2880	2720	2550	2370	2190	2020	1860
	* 10.0	119	4790	4790	4790	4790	4560	4320	4060	3780	3500	3210	2930	2670	2430
	* 12.0	142	6520	6520	6520	6400	6050	5680	5290	4880	4460	4040	3660	3300	2980
	15.0	174	8850	8850	8850	8550	8040	7490	6910	6300	5700	5130	4600	4120	3700

* Section is slender under axial compression and allowance has been made in calculating the compression resistance.

For explanation of table see Section 8.4.

Table 56

COMPRESSION

CHANNELS
SUBJECT TO AXIAL COMPRESSION

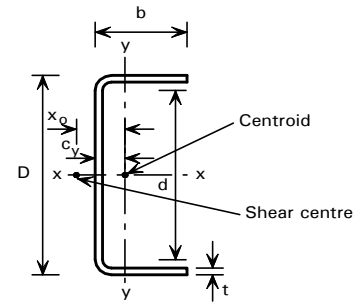

COMPRESSION RESISTANCE FOR GRADE 1.4362 (SAF 2304)

D x b mm	t mm	Mass per Metre kg	Axis	Compression Resistance, P _{cx} , P _{oxz} , P _{cy} (kN)													
				for Effective Length L _E (m)													
				1.0	1.5	2.0	2.5	3.0	3.5	4.0	5.0	6.0	7.0	8.0	9.0	10.0	
50 x 25	* 2.0	1.45	P _{cx}	53.2	36.5	24.2	16.8	12.2	9.24	7.24	4.77	3.38	2.52	1.95	1.55	1.27	
			P _{oxz}	25.6	20.2	16.3	13.0	10.3	8.26	6.69	4.58	3.31	2.49	1.94	1.55	1.27	
			P _{cy}	17.0	8.28	4.85	3.18	2.25	1.67	1.29	0.836	0.585	0.433	0.333	0.264	0.214	
	3.0	2.08	P _{cx}	80.0	52.1	33.8	23.1	16.7	12.6	9.87	6.49	4.59	3.42	2.64	2.11	1.72	
			P _{oxz}	54.1	41.0	29.6	21.5	16.1	12.4	9.76	6.50	4.62	3.45	2.67	2.13	1.73	
			P _{cy}	24.0	11.6	6.75	4.42	3.12	2.31	1.79	1.16	0.810	0.599	0.460	0.365	0.296	
75 x 35	* 3.0	3.14	P _{cx}	140	116	90.8	68.4	52.0	40.4	32.1	21.5	15.4	11.6	9.00	7.20	5.89	
			P _{oxz}	73.2	57.9	49.6	43.1	37.1	31.7	26.9	19.5	14.5	11.2	8.80	7.10	5.84	
			P _{cy}	62.8	32.4	19.3	12.8	9.09	6.79	5.26	3.42	2.40	1.78	1.37	1.09	0.886	
	4.0	4.06	P _{cx}	192	156	118	87.7	66.0	50.9	40.3	27.0	19.3	14.4	11.2	8.97	7.34	
			P _{oxz}	118	100	84.8	70.0	56.8	46.1	37.7	26.2	19.0	14.4	11.2	9.01	7.38	
			P _{cy}	81.2	41.3	24.6	16.2	11.5	8.58	6.65	4.32	3.03	2.25	1.73	1.37	1.12	
	5.0	4.91	P _{cx}	230	186	139	102	77.0	59.3	46.9	31.4	22.4	16.8	13.0	10.4	8.51	
			P _{oxz}	165	142	116	92.0	72.1	57.1	45.9	31.3	22.5	16.9	13.2	10.5	8.62	
			P _{cy}	96.2	48.8	29.0	19.1	13.6	10.1	7.83	5.09	3.58	2.65	2.04	1.62	1.32	
	100 x 50	* 3.0	4.45	P _{cx}	174	166	148	127	107	88.8	73.4	51.5	37.7	28.7	22.5	18.1	14.9
				P _{oxz}	107	75.5	59.4	50.4	44.7	40.6	37.2	31.5	26.6	22.3	18.8	15.8	13.4
				P _{cy}	128	81.1	51.8	35.3	25.5	19.2	15.0	9.85	6.96	5.18	4.01	3.19	2.60
* 4.0		5.80	P _{cx}	264	244	212	178	146	118	97.0	67.1	48.8	37.0	28.9	23.3	19.1	
			P _{oxz}	160	122	102	90.2	80.9	72.8	65.4	52.1	41.4	33.0	26.8	22.0	18.3	
			P _{cy}	180	108	68.2	46.1	33.1	24.9	19.4	12.7	8.98	6.68	5.16	4.10	3.34	
* 5.0		7.08	P _{cx}	346	314	270	222	179	144	117	80.7	58.5	44.2	34.6	27.8	22.8	
			P _{oxz}	219	180	156	138	122	107	93.7	70.6	53.9	42.0	33.4	27.2	22.5	
			P _{cy}	226	133	82.8	55.8	40.0	30.1	23.4	15.3	10.8	8.04	6.20	4.93	4.02	
125 x 50		* 3.0	5.04	P _{cx}	181	181	170	155	139	122	105	78.7	59.2	45.8	36.3	29.4	24.3
				P _{oxz}	124	89.7	69.2	57.6	50.6	46.0	42.6	37.7	33.8	30.2	26.7	23.5	20.5
				P _{cy}	135	86.4	55.4	37.9	27.3	20.6	16.1	10.6	7.48	5.57	4.30	3.43	2.79
	* 4.0	6.59	P _{cx}	294	290	264	235	204	174	147	106	78.6	60.2	47.4	38.3	31.6	
			P _{oxz}	191	143	117	103	93.7	86.7	80.8	70.0	59.6	50.0	41.8	35.0	29.6	
			P _{cy}	197	118	73.9	49.9	35.8	27.0	21.0	13.8	9.71	7.22	5.57	4.43	3.61	
	* 5.0	8.07	P _{cx}	396	384	346	304	260	218	182	129	95.5	72.9	57.3	46.2	38.0	
			P _{oxz}	260	208	180	163	150	138	126	103	83.3	66.8	54.2	44.5	37.1	
			P _{cy}	251	145	90.4	60.8	43.6	32.7	25.4	16.7	11.7	8.72	6.73	5.36	4.36	
	6.0	9.49	P _{cx}	480	462	414	360	305	255	212	150	110	83.9	65.9	53.1	43.7	
			P _{oxz}	330	281	253	232	212	192	171	133	102	80.7	64.5	52.5	43.5	
			P _{cy}	297	170	105	70.6	50.5	37.9	29.5	19.3	13.6	10.1	7.79	6.20	5.04	
150 x 60	* 4.0	8.01	P _{cx}	313	313	306	285	262	237	211	164	126	99.4	79.4	64.7	53.7	
			P _{oxz}	234	177	139	116	102	92.6	85.7	76.0	68.7	62.1	55.7	49.6	43.8	
			P _{cy}	256	178	119	83.0	60.4	45.8	35.9	23.7	16.8	12.5	9.70	7.73	6.30	
	* 5.0	9.85	P _{cx}	452	452	431	396	358	318	278	209	158	123	98.0	79.6	65.8	
			P _{oxz}	326	251	206	179	161	149	139	123	109	94.7	81.3	69.6	59.6	
			P _{cy}	349	230	150	103	74.7	56.4	44.1	29.0	20.5	15.3	11.8	9.42	7.68	
	* 6.0	11.6	P _{cx}	571	571	536	489	438	385	333	247	186	144	114	92.7	76.6	
			P _{oxz}	412	331	284	255	235	219	204	176	149	124	103	86.5	73.0	
			P _{cy}	427	275	177	121	87.5	66.1	51.6	33.9	24.0	17.9	13.8	11.0	8.96	
	8.0	15.0	P _{cx}	757	757	702	637	565	492	423	311	233	179	142	115	94.9	
			P _{oxz}	573	504	462	430	401	370	337	271	215	171	138	113	94.4	
			P _{cy}	554	350	224	152	110	83.1	64.8	42.6	30.1	22.4	17.3	13.8	11.2	

See Section 8.4.2 for guidance on calculating an effective length which allows for both the effects of end fixity and nominal end moments due to eccentricity of connection.

Slender sections must also be checked for the combined effects of the axial load and moment caused by the shift of neutral axis, see Section 8.4.2.

* Section is slender under axial compression and allowance has been made in calculating the compression resistance.

For explanation of table see Section 8.4

Table 56

COMPRESSION

CHANNELS
SUBJECT TO AXIAL COMPRESSION

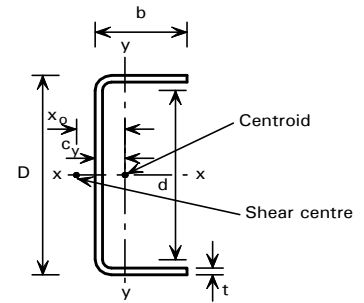

COMPRESSION RESISTANCE FOR GRADE 1.4362 (SAF 2304)

D x b mm	t mm	Mass per Metre kg	Axis	Compression Resistance, P_{cx} , P_{czz} , P_{cy} (kN)												
				for Effective Length L_E (m)												
				1.0	1.5	2.0	2.5	3.0	3.5	4.0	5.0	6.0	7.0	8.0	9.0	10.0
175 x 60	* 5.0	10.8	P_{cx}	468	468	466	438	407	374	339	270	212	168	135	110	92.2
			P_{czz}	352	274	221	189	170	156	147	133	122	111	100	89.8	79.2
			P_{cy}	363	240	157	107	78.2	59.1	46.2	30.4	21.5	16.0	12.4	9.88	8.06
	* 6.0	12.8	P_{cx}	628	628	615	573	527	477	426	331	256	200	160	130	108
			P_{czz}	462	366	307	272	250	234	222	201	180	158	137	117	100
			P_{cy}	462	293	187	128	92.5	69.7	54.4	35.8	25.3	18.8	14.5	11.6	9.43
	8.0	16.5	P_{cx}	837	837	812	753	688	618	548	421	323	252	201	163	135
			P_{czz}	637	550	499	465	440	417	394	341	285	234	192	159	133
			P_{cy}	601	375	238	162	116	88.0	68.6	45.1	31.8	23.7	18.3	14.6	11.9
	10.0	20.0	P_{cx}	1010	1010	977	903	822	735	649	494	378	294	234	190	157
			P_{czz}	807	742	703	671	639	600	555	454	362	289	233	191	159
			P_{cy}	719	445	282	191	137	103	81.0	53.2	37.5	27.9	21.6	17.2	14.0
200 x 75	* 5.0	13.0	P_{cx}	495	495	495	493	468	443	415	356	297	245	202	168	141
			P_{czz}	413	341	274	226	194	172	157	137	124	115	107	100	93.0
			P_{cy}	451	356	261	190	141	108	85.8	57.2	40.8	30.5	23.7	18.9	15.4
	* 6.0	15.4	P_{cx}	671	671	671	655	619	580	539	451	368	299	244	201	168
			P_{czz}	547	447	365	309	272	247	229	205	187	173	159	145	131
			P_{cy}	594	452	321	229	169	129	101	67.7	48.2	36.0	27.9	22.3	18.2
	* 8.0	20.0	P_{cx}	1000	1000	1000	955	894	828	758	616	491	392	317	260	217
			P_{czz}	801	670	576	515	474	444	420	380	342	303	264	229	197
			P_{cy}	854	621	427	300	220	167	131	87.0	61.8	46.1	35.7	28.5	23.3
	10.0	24.4	P_{cx}	1230	1230	1230	1170	1090	1010	917	739	586	466	376	308	257
			P_{czz}	1000	881	801	747	707	672	639	568	490	414	348	293	248
			P_{cy}	1040	750	512	359	263	199	156	103	73.7	55.0	42.6	33.9	27.7
225 x 75	* 6.0	16.6	P_{cx}	687	687	687	687	661	628	593	517	438	366	304	255	215
			P_{czz}	573	475	388	326	285	256	236	210	194	181	170	160	149
			P_{cy}	610	465	331	237	175	134	105	70.1	49.9	37.3	28.9	23.1	18.9
	* 8.0	21.6	P_{cx}	1080	1080	1080	1060	1010	945	880	742	609	496	406	336	281
			P_{czz}	875	728	618	545	497	463	439	403	373	343	311	278	246
			P_{cy}	912	656	448	314	229	174	137	90.6	64.3	48.0	37.2	29.6	24.2
	10.0	26.3	P_{cx}	1330	1330	1330	1300	1230	1150	1070	895	731	593	484	400	334
			P_{czz}	1090	950	853	789	745	711	682	628	567	500	433	371	319
			P_{cy}	1120	794	539	376	275	209	163	108	76.9	57.3	44.4	35.4	28.9
	12.0	30.8	P_{cx}	1560	1560	1560	1520	1430	1340	1240	1030	837	676	551	455	380
			P_{czz}	1300	1180	1100	1050	1010	973	936	846	738	626	527	443	376
			P_{cy}	1300	918	620	432	315	239	187	124	88.1	65.7	50.9	40.6	33.1
250 x 100	* 6.0	20.2	P_{cx}	727	727	727	727	727	710	683	623	557	489	423	365	314
			P_{czz}	655	582	499	421	358	311	276	230	202	184	170	159	150
			P_{cy}	727	642	540	436	345	274	221	151	109	82.5	64.4	51.6	42.3
	* 8.0	26.3	P_{cx}	1180	1180	1180	1180	1160	1110	1060	941	818	697	589	498	424
			P_{czz}	1030	900	766	655	573	513	470	412	374	346	323	301	279
			P_{cy}	1150	981	790	612	472	369	295	199	143	107	84.0	67.2	55.0
	* 10.0	32.3	P_{cx}	1590	1590	1590	1590	1540	1470	1390	1220	1040	873	730	613	518
			P_{czz}	1370	1200	1040	921	834	770	722	652	600	552	506	460	414
			P_{cy}	1520	1280	1010	764	583	454	361	243	174	130	101	81.4	66.6
	12.0	37.9	P_{cx}	1920	1920	1920	1920	1850	1760	1660	1440	1220	1020	849	710	600
			P_{czz}	1660	1480	1320	1210	1130	1060	1010	928	849	768	685	605	532
			P_{cy}	1830	1530	1190	896	680	528	420	282	202	151	117	94.3	77.1

See Section 8.4.2 for guidance on calculating an effective length which allows for both the effects of end fixity and nominal end moments due to eccentricity of connection.

Slender sections must also be checked for the combined effects of the axial load and moment caused by the shift of neutral axis, see Section 8.4.2.

* Section is slender under axial compression and allowance has been made in calculating the compression resistance.

For explanation of table see Section 8.4

Table 56

COMPRESSION

**CHANNELS
SUBJECT TO AXIAL COMPRESSION**

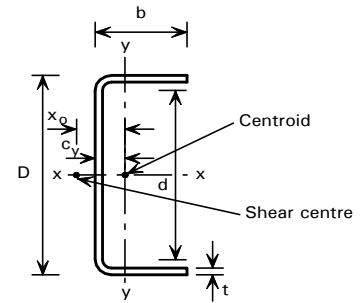

COMPRESSION RESISTANCE FOR GRADE 1.4362 (SAF 2304)

D x b mm	t mm	Mass per Metre kg	Axis	Compression Resistance, P_{cx} , P_{cxz} , P_{cy} (kN)												
				for Effective Length L_E (m)												
				1.0	1.5	2.0	2.5	3.0	3.5	4.0	5.0	6.0	7.0	8.0	9.0	10.0
300 x 100	* 8.0	29.5	P_{cx}	1220	1220	1220	1220	1220	1220	1180	1090	988	884	779	681	593
			P_{cxz}	1100	976	845	726	630	559	506	437	394	366	345	328	313
			P_{cy}	1200	1020	828	643	497	389	311	210	151	113	88.7	71.0	58.2
	* 10.0	36.2	P_{cx}	1760	1760	1760	1760	1760	1710	1650	1500	1340	1170	1010	871	750
			P_{cxz}	1550	1360	1180	1030	920	838	778	699	647	609	576	544	512
			P_{cy}	1680	1400	1090	822	624	485	385	259	185	139	108	86.6	70.8
	12.0	42.7	P_{cx}	2160	2160	2160	2160	2160	2090	2000	1810	1600	1390	1200	1020	877
			P_{cxz}	1900	1680	1490	1340	1240	1160	1100	1010	951	895	838	777	712
			P_{cy}	2040	1680	1300	968	732	567	450	301	215	161	125	100	82.3
	15.0	51.9	P_{cx}	2630	2630	2630	2630	2630	2520	2410	2180	1920	1660	1420	1210	1040
			P_{cxz}	2310	2100	1940	1820	1740	1670	1620	1530	1430	1330	1210	1080	955
			P_{cy}	2480	2030	1550	1160	872	674	535	358	256	192	149	119	97.6
350 x 125	* 8.0	35.8	P_{cx}	1290	1290	1290	1290	1290	1290	1290	1250	1180	1100	1010	927	839
			P_{cxz}	1220	1130	1030	914	804	708	629	515	443	395	362	337	319
			P_{cy}	1290	1230	1100	946	794	657	544	382	279	212	167	134	110
	* 10.0	44.1	P_{cx}	1880	1880	1880	1880	1880	1880	1880	1770	1650	1520	1380	1240	1100
			P_{cxz}	1750	1600	1440	1280	1130	1000	906	771	686	629	588	557	530
			P_{cy}	1880	1740	1520	1270	1040	844	690	477	347	263	205	165	135
	* 12.0	52.2	P_{cx}	2530	2530	2530	2530	2530	2530	2490	2320	2140	1940	1740	1540	1360
			P_{cxz}	2320	2110	1890	1680	1500	1360	1250	1100	1000	937	884	840	798
			P_{cy}	2530	2280	1940	1590	1280	1020	828	568	411	310	242	194	159
	15.0	63.7	P_{cx}	3230	3230	3230	3230	3230	3230	3140	2910	2670	2410	2140	1880	1650
			P_{cxz}	2940	2690	2440	2230	2060	1920	1820	1670	1570	1480	1400	1320	1230
			P_{cy}	3230	2860	2420	1960	1560	1240	1000	685	495	373	291	234	191
400 x 150	* 8.0	42.1	P_{cx}	1350	1350	1350	1350	1350	1350	1350	1310	1250	1190	1120	1050	
			P_{cxz}	1310	1240	1160	1070	975	878	786	636	531	458	406	369	341
			P_{cy}	1350	1350	1270	1160	1040	918	798	594	448	347	275	223	184
	* 10.0	52.0	P_{cx}	1980	1980	1980	1980	1980	1980	1980	1970	1880	1770	1660	1550	1430
			P_{cxz}	1900	1780	1650	1510	1360	1220	1100	906	777	689	628	582	548
			P_{cy}	1980	1970	1810	1620	1430	1230	1050	760	566	434	343	277	228
	* 12.0	61.6	P_{cx}	2690	2690	2690	2690	2690	2690	2690	2620	2480	2320	2160	1980	1810
			P_{cxz}	2550	2380	2190	1990	1790	1610	1460	1240	1090	989	917	863	820
			P_{cy}	2690	2630	2380	2100	1810	1530	1290	918	678	518	407	329	270
	* 15.0	75.6	P_{cx}	3720	3720	3720	3720	3720	3720	3720	3560	3340	3100	2840	2580	2320
			P_{cxz}	3490	3240	2970	2710	2460	2260	2090	1840	1680	1560	1470	1400	1330
			P_{cy}	3720	3560	3190	2770	2340	1940	1610	1140	833	634	498	401	329

See Section 8.4.2 for guidance on calculating an effective length which allows for both the effects of end fixity and nominal end moments due to eccentricity of connection.

Slender sections must also be checked for the combined effects of the axial load and moment caused by the shift of neutral axis, see Section 8.4.2.

* Section is slender under axial compression and allowance has been made in calculating the compression resistance.

For explanation of table see Section 8.4

Table 57

COMPRESSION

**DOUBLE CHANNELS BACK TO BACK
SUBJECT TO AXIAL COMPRESSION**

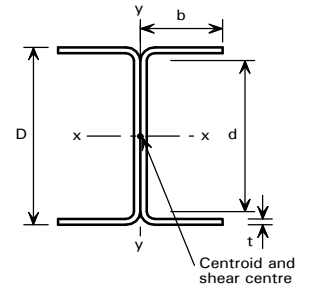

COMPRESSION RESISTANCE FOR GRADE 1.4362 (SAF 2304)

D x 2b mm	t mm	Mass per Metre kg	Axis	Compression Resistance, P_{cx} , P_{cy} , P_{cz} (kN)													
				for Effective Length L_E (m)													
				1.0	1.5	2.0	2.5	3.0	3.5	4.0	5.0	6.0	7.0	8.0	9.0	10.0	
50 x 50	* 2.0	2.90	P_{cx}	84.2	58.1	40.3	28.9	21.5	16.6	13.2	8.86	6.35	4.78	3.72	2.98	2.44	
			P_{cy}	46.2	25.4	15.7	10.6	7.64	5.76	4.50	2.96	2.09	1.56	1.20	0.958	0.781	
			P_{cz}	82.7	69.9	64.2	61.2	59.6	58.5	57.9	57.0	56.6	56.3	56.2	56.0	55.9	
	3.0	4.15	P_{cx}	127	84.4	57.1	40.4	29.9	23.0	18.2	12.1	8.69	6.52	5.07	4.06	3.32	
			P_{cy}	71.5	38.9	24.0	16.2	11.6	8.76	6.83	4.49	3.17	2.36	1.82	1.45	1.18	
			P_{cz}	154	146	143	141	140	139	139	139	138	138	138	138	138	
75 x 70	* 3.0	6.28	P_{cx}	230	184	143	110	86.7	69.0	55.9	38.6	28.1	21.4	16.8	13.5	11.1	
			P_{cy}	147	90.0	58.4	40.4	29.5	22.5	17.7	11.7	8.34	6.24	4.84	3.86	3.15	
			P_{cz}	213	178	159	148	142	138	135	132	130	129	128	128	127	
	* 4.0	8.12	P_{cx}	315	246	188	143	111	87.9	70.9	48.7	35.4	26.9	21.1	16.9	13.9	
			P_{cy}	201	122	79.0	54.6	39.8	30.3	23.8	15.8	11.2	8.39	6.50	5.19	4.24	
			P_{cz}	311	282	268	260	256	253	251	249	247	247	246	246	246	
	5.0	9.82	P_{cx}	381	295	223	169	130	102	82.9	56.8	41.2	31.3	24.5	19.7	16.2	
			P_{cy}	251	153	99.1	68.5	50.0	38.1	29.9	19.8	14.1	10.6	8.19	6.54	5.34	
			P_{cz}	403	385	376	372	370	368	367	366	365	365	365	364	364	
100 x 100	* 3.0	8.89	P_{cx}	314	274	236	201	169	142	120	87.6	65.9	51.1	40.7	33.1	27.5	
			P_{cy}	247	182	132	97.8	74.1	57.8	46.2	31.3	22.6	17.1	13.3	10.7	8.78	
			P_{cz}	293	250	211	182	162	148	138	126	120	115	113	111	109	
	* 4.0	11.6	P_{cx}	462	397	336	280	232	192	161	115	86.1	66.5	52.7	42.8	35.4	
			P_{cy}	359	259	184	134	101	78.8	62.8	42.5	30.6	23.0	18.0	14.4	11.8	
			P_{cz}	434	376	330	300	279	266	256	244	238	234	231	229	228	
	* 5.0	14.2	P_{cx}	595	507	424	350	287	236	196	139	103	79.9	63.3	51.3	42.4	
			P_{cy}	463	331	235	170	128	99.6	79.3	53.5	38.5	29.0	22.6	18.1	14.9	
			P_{cz}	567	507	466	440	423	412	405	395	390	387	384	383	382	
125 x 100	* 3.0	10.1	P_{cx}	345	312	280	249	219	192	168	128	99.7	78.9	63.7	52.4	43.8	
			P_{cy}	254	186	134	98.9	74.8	58.2	46.5	31.5	22.7	17.1	13.4	10.7	8.81	
			P_{cz}	310	265	222	187	163	146	134	119	110	105	101	99.1	97.3	
	* 4.0	13.2	P_{cx}	544	484	427	372	321	276	237	176	134	105	84.6	69.2	57.6	
			P_{cy}	387	273	191	138	103	80.3	63.9	43.0	30.9	23.3	18.1	14.5	11.9	
			P_{cz}	485	413	352	309	280	261	247	231	221	216	212	209	207	
	* 5.0	16.1	P_{cx}	720	636	555	478	408	347	295	217	165	128	102	83.9	69.7	
			P_{cy}	509	353	245	176	131	101	80.9	54.4	39.0	29.4	22.9	18.3	15.0	
			P_{cz}	646	561	498	457	430	412	399	384	375	370	366	364	362	
	6.0	19.0	P_{cx}	880	773	670	573	485	410	347	254	191	149	118	96.9	80.5	
			P_{cy}	623	431	298	214	159	123	97.9	65.8	47.2	35.5	27.6	22.1	18.1	
			P_{cz}	800	715	660	625	603	588	578	566	559	555	552	550	549	
150 x 120	* 4.0	16.0	P_{cx}	610	559	510	463	417	373	333	263	208	167	136	113	95.3	
			P_{cy}	473	366	276	209	161	127	102	70.1	50.9	38.6	30.2	24.3	20.0	
			P_{cz}	552	489	424	367	322	290	266	235	217	206	198	193	189	
	* 5.0	19.7	P_{cx}	865	786	710	636	566	499	439	339	265	211	171	140	118	
			P_{cy}	659	497	367	274	209	163	131	89.5	64.7	49.0	38.3	30.8	25.3	
			P_{cz}	781	687	599	530	479	444	418	385	366	354	347	341	337	
	* 6.0	23.2	P_{cx}	1080	976	877	781	689	604	528	404	313	248	200	165	138	
			P_{cy}	819	613	450	334	254	199	159	108	78.3	59.2	46.3	37.2	30.5	
			P_{cz}	975	866	774	706	658	625	601	571	553	542	535	530	527	
	8.0	29.9	P_{cx}	1450	1300	1160	1030	897	781	678	513	395	312	251	206	172	
			P_{cy}	1110	827	607	450	343	268	214	146	105	79.7	62.3	50.1	41.1	
			P_{cz}	1320	1210	1140	1090	1060	1040	1020	1000	989	983	978	975	973	

* Section is slender under axial compression and allowance has been made in calculating the compression resistance.
For explanation of table see Section 8.4.

Table 57

COMPRESSION

**DOUBLE CHANNELS BACK TO BACK
SUBJECT TO AXIAL COMPRESSION**

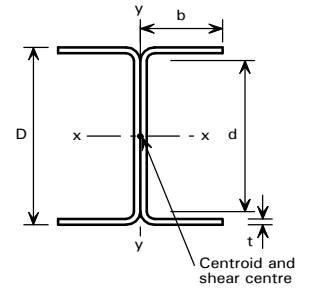

COMPRESSION RESISTANCE FOR GRADE 1.4362 (SAF 2304)

D x 2b mm	t mm	Mass per Metre kg	Axis	Compression Resistance, P_{cx} , P_{cy} , P_{cz} (kN)												
				for Effective Length L_E (m)												
				1.0	1.5	2.0	2.5	3.0	3.5	4.0	5.0	6.0	7.0	8.0	9.0	10.0
175 x 120	* 5.0	21.7	P_{cx}	921	851	783	717	653	591	533	429	345	280	230	191	161
			P_{cy}	675	506	372	277	211	165	132	90.0	65.0	49.2	38.4	30.9	25.3
			P_{cz}	812	714	618	538	479	437	406	367	345	331	321	315	310
	* 6.0	25.6	P_{cx}	1220	1120	1020	929	838	751	670	529	420	338	276	229	192
			P_{cy}	880	646	467	344	260	202	162	109	79.2	59.8	46.7	37.5	30.7
			P_{cz}	1070	940	822	733	670	625	594	554	531	517	508	501	496
	8.0	33.1	P_{cx}	1640	1500	1360	1230	1100	982	870	681	536	429	349	288	242
			P_{cy}	1190	874	631	464	351	273	218	148	106	80.7	63.0	50.6	41.5
			P_{cz}	1450	1310	1210	1140	1090	1060	1030	1000	985	975	968	963	960
	10.0	40.1	P_{cx}	1980	1800	1640	1470	1320	1170	1030	802	630	502	408	337	282
			P_{cy}	1460	1080	787	581	441	344	275	187	135	101	79.7	64.0	52.5
			P_{cz}	1780	1660	1590	1540	1510	1490	1480	1460	1460	1450	1450	1440	1440
200 x 150	* 5.0	26.0	P_{cx}	977	945	885	828	771	716	662	561	471	395	332	282	241
			P_{cy}	818	675	545	434	346	280	229	160	117	90.0	70.9	57.3	47.3
			P_{cz}	911	837	756	672	596	533	483	413	370	343	324	311	301
	* 6.0	30.8	P_{cx}	1320	1260	1170	1090	1010	930	853	710	587	487	406	342	291
			P_{cy}	1080	881	698	548	433	347	283	196	144	109	86.3	69.7	57.4
			P_{cz}	1220	1110	998	890	799	726	670	594	548	518	498	484	474
	* 8.0	40.0	P_{cx}	1970	1840	1700	1570	1440	1310	1190	972	791	647	535	447	378
			P_{cy}	1580	1270	987	766	600	478	388	268	195	148	117	94.3	77.6
			P_{cz}	1790	1630	1480	1360	1260	1190	1140	1060	1020	993	975	962	953
	10.0	48.7	P_{cx}	2470	2290	2110	1940	1770	1610	1460	1180	953	776	639	533	451
			P_{cy}	1980	1590	1240	964	756	602	488	338	246	187	147	118	97.8
			P_{cz}	2240	2070	1930	1820	1750	1700	1660	1600	1570	1550	1540	1530	1530
225 x 150	* 6.0	33.2	P_{cx}	1350	1320	1250	1170	1090	1020	950	814	691	585	496	423	363
			P_{cy}	1100	895	707	554	437	349	284	197	144	110	86.6	69.9	57.5
			P_{cz}	1250	1140	1030	911	811	730	667	582	530	496	474	458	447
	* 8.0	43.2	P_{cx}	2130	2040	1900	1770	1640	1510	1390	1170	968	804	673	568	484
			P_{cy}	1680	1330	1030	789	614	487	394	271	197	150	118	95.1	78.2
			P_{cz}	1930	1750	1570	1420	1300	1210	1140	1050	1000	967	944	928	916
	10.0	52.7	P_{cx}	2670	2540	2360	2190	2030	1870	1710	1420	1170	970	809	681	579
			P_{cy}	2110	1670	1290	994	774	614	497	342	249	189	148	119	98.6
			P_{cz}	2410	2210	2040	1910	1810	1740	1680	1610	1570	1550	1530	1520	1510
	12.0	61.7	P_{cx}	3120	2960	2750	2550	2350	2160	1980	1640	1350	1110	924	776	659
			P_{cy}	2490	1980	1540	1190	930	740	599	414	301	229	180	145	119
			P_{cz}	2830	2640	2490	2390	2320	2270	2230	2190	2160	2140	2130	2130	2120
250 x 200	* 6.0	40.3	P_{cx}	1440	1440	1380	1320	1250	1190	1120	997	879	770	673	587	514
			P_{cy}	1330	1170	1020	876	746	633	538	395	299	232	186	151	126
			P_{cz}	1400	1320	1240	1160	1060	973	888	750	652	584	536	502	476
	* 8.0	52.7	P_{cx}	2320	2300	2180	2060	1940	1820	1710	1490	1290	1100	948	816	706
			P_{cy}	2090	1810	1550	1310	1090	913	767	554	415	321	255	207	172
			P_{cz}	2220	2090	1940	1800	1650	1520	1410	1240	1120	1050	991	953	925
	* 10.0	64.5	P_{cx}	3120	3060	2880	2710	2550	2380	2220	1920	1640	1390	1180	1010	871
			P_{cy}	2780	2400	2040	1700	1420	1180	983	707	527	407	323	262	217
			P_{cz}	2960	2770	2590	2410	2250	2110	2000	1830	1720	1650	1600	1560	1540
	12.0	75.9	P_{cx}	3840	3750	3520	3310	3090	2890	2680	2290	1940	1640	1390	1190	1020
			P_{cy}	3420	2940	2490	2080	1720	1430	1190	857	639	493	391	317	263
			P_{cz}	3630	3410	3200	3020	2860	2740	2640	2500	2410	2360	2320	2290	2270

* Section is slender under axial compression and allowance has been made in calculating the compression resistance.

For explanation of table see Section 8.4.

Table 57

COMPRESSION

DOUBLE CHANNELS BACK TO BACK
SUBJECT TO AXIAL COMPRESSION

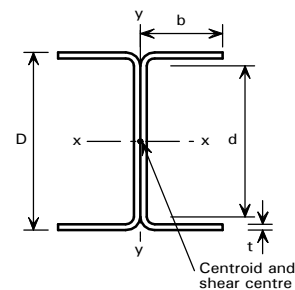

COMPRESSION RESISTANCE FOR GRADE 1.4362 (SAF 2304)

D x 2b mm	t mm	Mass per Metre kg	Axis	Compression Resistance, P_{cx} , P_{cy} , P_{cz} (kN)												
				for Effective Length L_E (m)												
				1.0	1.5	2.0	2.5	3.0	3.5	4.0	5.0	6.0	7.0	8.0	9.0	10.0
300 x 200	* 8.0	59.0	P_{cx}	2410	2410	2350	2250	2150	2050	1950	1750	1570	1390	1230	1090	958
			P_{cy}	2160	1870	1590	1340	1110	927	777	560	418	323	257	208	173
			P_{cz}	2320	2180	2030	1880	1720	1570	1440	1240	1100	1010	942	896	861
	* 10.0	72.4	P_{cx}	3460	3460	3320	3160	3000	2840	2690	2390	2110	1840	1610	1400	1230
			P_{cy}	3040	2600	2180	1800	1480	1220	1020	724	538	414	328	266	220
			P_{cz}	3290	3080	2850	2630	2420	2240	2080	1860	1710	1610	1540	1500	1460
	12.0	85.4	P_{cx}	4320	4320	4120	3900	3700	3500	3300	2910	2550	2210	1920	1670	1450
			P_{cy}	3780	3220	2690	2220	1820	1490	1240	881	654	503	398	322	266
			P_{cz}	4080	3820	3560	3310	3100	2920	2770	2560	2430	2340	2280	2240	2200
	15.0	103	P_{cx}	5250	5250	4980	4720	4470	4220	3970	3490	3050	2640	2280	1980	1720
			P_{cy}	4630	3960	3320	2750	2260	1860	1550	1110	822	633	501	406	336
			P_{cz}	4950	4660	4400	4190	4020	3880	3780	3640	3550	3490	3450	3420	3400
350 x 250	* 8.0	71.6	P_{cx}	2550	2550	2550	2500	2410	2330	2240	2080	1920	1760	1600	1460	1320
			P_{cy}	2460	2220	2000	1780	1570	1370	1200	918	712	564	455	374	313
			P_{cz}	2530	2430	2320	2200	2080	1950	1820	1570	1360	1210	1090	1000	937
	* 10.0	88.2	P_{cx}	3710	3710	3710	3570	3440	3300	3170	2900	2650	2400	2170	1950	1750
			P_{cy}	3520	3150	2800	2460	2150	1860	1610	1210	928	729	586	480	400
			P_{cz}	3650	3480	3310	3130	2940	2740	2560	2230	1990	1810	1670	1580	1500
	* 12.0	104	P_{cx}	4980	4980	4930	4730	4530	4330	4140	3770	3400	3060	2730	2430	2170
			P_{cy}	4670	4150	3660	3190	2750	2360	2020	1500	1150	897	718	587	489
			P_{cz}	4860	4620	4370	4120	3860	3620	3390	3020	2750	2560	2430	2330	2250
	15.0	127	P_{cx}	6450	6450	6340	6060	5800	5530	5280	4770	4280	3820	3390	3000	2660
			P_{cy}	6030	5350	4700	4080	3510	3010	2570	1910	1450	1140	909	743	618
			P_{cz}	6260	5940	5640	5340	5060	4810	4590	4250	4020	3860	3740	3660	3590
400 x 300	* 8.0	84.3	P_{cx}	2670	2670	2670	2670	2620	2550	2470	2330	2190	2050	1910	1780	1650
			P_{cy}	2670	2480	2290	2110	1930	1760	1590	1290	1050	854	704	588	497
			P_{cz}	2670	2610	2520	2430	2340	2240	2140	1910	1690	1500	1330	1200	1100
	* 10.0	104	P_{cx}	3910	3910	3910	3900	3780	3660	3540	3310	3090	2870	2650	2440	2250
			P_{cy}	3880	3570	3270	2980	2700	2430	2180	1740	1390	1120	917	761	641
			P_{cz}	3910	3780	3650	3500	3350	3190	3020	2690	2390	2130	1930	1780	1660
	* 12.0	123	P_{cx}	5290	5290	5290	5220	5040	4870	4700	4370	4040	3720	3410	3120	2840
			P_{cy}	5200	4760	4340	3920	3520	3150	2790	2200	1730	1390	1130	937	787
			P_{cz}	5270	5070	4870	4670	4450	4220	4000	3560	3200	2910	2680	2510	2380
	* 15.0	151	P_{cx}	7310	7310	7310	7110	6850	6600	6350	5860	5380	4910	4470	4050	3660
			P_{cy}	7120	6490	5880	5280	4710	4170	3680	2860	2240	1790	1450	1200	1000
			P_{cz}	7230	6940	6650	6350	6050	5750	5470	4970	4570	4270	4050	3880	3750

* Section is slender under axial compression and allowance has been made in calculating the compression resistance.

For explanation of table see Section 8.4.

Table 58

COMPRESSION

**EQUAL ANGLES
SUBJECT TO AXIAL COMPRESSION**

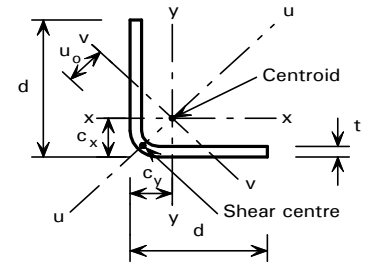

COMPRESSION RESISTANCE FOR GRADE 1.4362 (SAF 2304)

d x d mm	t mm	Mass per Metre kg	Axis	Compression Resistance, P_{cx} , P_{cy} , P_{ouz} , P_{cv} (kN)													
				for Effective Length L_E (m)													
				1.0	1.5	2.0	2.5	3.0	3.5	4.0	5.0	6.0	7.0	8.0	9.0	10.0	
50 x 50	* 5.0	3.54	P_{cx}, P_{cy}	99.8	62.7	40.0	27.2	19.6	14.8	11.5	7.58	5.36	3.98	3.08	2.45	2.00	
			P_{ouz}	101	80.2	58.2	42.1	31.2	23.9	18.9	12.5	8.89	6.63	5.13	4.09	3.33	
			P_{cv}	50.4	25.4	15.0	9.92	7.03	5.24	4.06	2.64	1.85	1.37	1.05	0.836	0.680	
75 x 75	* 6.0	6.52	P_{cx}, P_{cy}	202	166	128	95.9	72.5	56.2	44.6	29.9	21.4	16.0	12.5	9.96	8.15	
			P_{ouz}	162	153	137	117	98.0	80.7	66.6	46.6	34.1	25.9	20.3	16.3	13.4	
			P_{cv}	151	93.6	59.3	40.3	29.0	21.8	17.0	11.2	7.89	5.87	4.53	3.61	2.94	
100 x 100	* 8.0	11.6	P_{cx}, P_{cy}	380	345	296	244	197	158	128	88.7	64.3	48.6	38.0	30.5	25.0	
			P_{ouz}	294	285	272	252	227	200	174	130	98.5	76.3	60.6	49.1	40.6	
			P_{cv}	326	240	166	117	86.2	65.6	51.5	34.1	24.2	18.1	14.0	11.2	9.13	
120 x 120	* 8.0	14.1	P_{cx}, P_{cy}	401	395	360	320	278	237	200	144	106	81.9	64.5	52.1	42.9	
			P_{ouz}	293	287	281	271	258	242	223	183	148	119	97.4	80.3	67.2	
			P_{cv}	384	320	250	189	143	111	88.8	59.7	42.7	32.1	24.9	20.0	16.3	

See Section 8.4.2 for guidance on calculating an effective length which allows for both the effects of end fixity and nominal end moments due to eccentricity of connection.

Slender sections must also be checked for the combined effects of the axial load and moment caused by the shift of neutral axis, see Section 8.4.2

* Section is slender under axial compression and allowance has been made in calculating the compression resistance.

For explanation of table see Section 8.4

Table 58

COMPRESSION

**EQUAL ANGLES
SUBJECT TO AXIAL COMPRESSION**

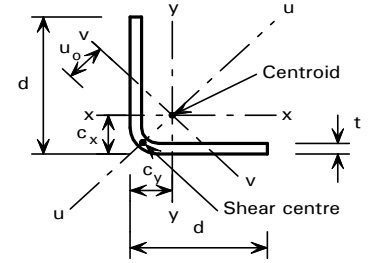

COMPRESSION RESISTANCE FOR GRADE 1.4362 (SAF 2304)

d x d mm	t mm	Mass per Metre kg	Axis	Compression Resistance, P_{cx} , P_{cy} , P_{ouz} , P_{cv} (kN)												
				for Effective Length L_E (m)												
				1.0	1.5	2.0	2.5	3.0	3.5	4.0	5.0	6.0	7.0	8.0	9.0	10.0
150 x 150	* 8.0	17.9	P_{cx}, P_{cy}	425	425	422	395	367	335	303	240	188	148	119	97.7	81.2
			P_{ouz}	282	278	274	269	264	257	250	229	205	179	155	133	115
			P_{cv}	425	397	348	295	243	198	163	113	82.7	62.7	49.1	39.5	32.4
	* 10.0	22.1	P_{cx}, P_{cy}	627	627	607	563	514	461	409	313	240	187	149	121	100
			P_{ouz}	462	455	448	439	427	412	394	349	299	252	212	179	152
			P_{cv}	627	562	478	390	312	250	202	138	100	75.8	59.2	47.5	39.0
	* 12.0	26.1	P_{cx}, P_{cy}	855	855	809	741	667	589	513	383	290	224	178	144	119
			P_{ouz}	672	662	650	634	612	584	550	471	391	322	266	221	186
			P_{cv}	848	735	606	479	374	295	237	161	115	87.3	68.1	54.6	44.7
	* 15.0	31.9	P_{cx}, P_{cy}	1240	1230	1130	1020	898	775	662	482	359	276	218	176	145
			P_{ouz}	1030	1020	994	961	915	858	792	651	523	420	341	281	234
			P_{cv}	1190	996	783	594	453	352	280	188	135	101	79.1	63.3	51.8
200 x 200	* 8.0	24.2	P_{cx}, P_{cy}	451	451	451	451	449	431	411	369	324	279	238	202	172
			P_{ouz}	257	251	248	245	243	241	238	232	225	215	205	192	179
			P_{cv}	451	451	440	408	374	338	300	232	179	140	111	91.1	75.5
	* 10.0	30.0	P_{cx}, P_{cy}	674	674	674	674	654	623	589	517	442	371	310	260	220
			P_{ouz}	440	430	425	421	417	412	406	391	373	350	323	295	268
			P_{cv}	674	674	636	582	522	460	400	298	225	174	138	112	92.8
	* 12.0	35.6	P_{cx}, P_{cy}	929	929	929	926	881	832	781	671	560	462	381	317	267
			P_{ouz}	663	651	644	637	629	620	609	580	542	497	448	400	355
			P_{cv}	929	927	850	765	673	580	495	360	268	206	163	131	108
	* 15.0	43.7	P_{cx}, P_{cy}	1360	1360	1360	1330	1250	1170	1080	902	733	592	483	398	333
			P_{ouz}	1060	1050	1030	1020	1010	986	962	898	816	726	635	553	480
			P_{cv}	1360	1320	1190	1050	892	749	626	444	327	249	196	158	130

See Section 8.4.2 for guidance on calculating an effective length which allows for both the effects of end fixity and nominal end moments due to eccentricity of connection.

Slender sections must also be checked for the combined effects of the axial load and moment caused by the shift of neutral axis, see Section 8.4.2

* Section is slender under axial compression and allowance has been made in calculating the compression resistance.

For explanation of table see Section 8.4

Table 59

COMPRESSION

**DOUBLE ANGLES BACK TO BACK
SUBJECT TO AXIAL COMPRESSION**

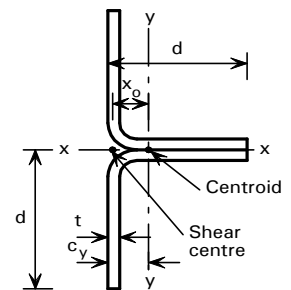

COMPRESSION RESISTANCE FOR GRADE 1.4362 (SAF 2304)

2d x d mm	t mm	Mass per Metre kg	Axis	Compression Resistance, P_{cx} , P_{czz} , P_{cy} (kN)												
				for Effective Length L_E (m)												
				1.0	1.5	2.0	2.5	3.0	3.5	4.0	5.0	6.0	7.0	8.0	9.0	10.0
100 x 50	* 5.0	7.08	P_{cx}	199	149	109	80.8	61.5	48.0	38.4	26.1	18.9	14.3	11.1	8.95	7.35
			P_{czz}	212	177	133	97.8	73.0	56.0	44.2	29.4	20.9	15.6	12.1	9.61	7.83
			P_{cy}	158	102	68.2	47.9	35.3	27.0	21.3	14.2	10.2	7.61	5.92	4.73	3.87
	* 6.0	8.30	P_{cx}	259	189	136	100	75.8	59.0	47.1	31.9	23.0	17.3	13.5	10.9	8.91
			P_{czz}	289	232	168	121	89.9	68.7	54.0	35.7	25.3	18.9	14.6	11.6	9.48
			P_{cy}	197	123	81.3	56.6	41.5	31.6	24.9	16.6	11.8	8.83	6.86	5.48	4.48
	8.0	10.5	P_{cx}	368	265	189	137	103	80.5	64.2	43.4	31.2	23.5	18.4	14.7	12.1
			P_{czz}	429	332	236	167	123	93.8	73.5	48.5	34.3	25.6	19.8	15.7	12.8
			P_{cy}	263	159	102	71.0	51.7	39.3	30.9	20.5	14.6	10.9	8.44	6.74	5.50
	10.0	12.5	P_{cx}	446	325	234	171	129	101	80.7	54.6	39.4	29.7	23.2	18.6	15.3
			P_{czz}	523	410	295	211	155	118	93.0	61.4	43.5	32.4	25.0	19.9	16.2
			P_{cy}	306	183	117	81.2	59.2	44.9	35.3	23.4	16.6	12.4	9.62	7.68	6.27
150 x 75	* 6.0	13.0	P_{cx}	377	322	271	224	184	152	126	90.7	67.4	51.9	41.1	33.4	27.6
			P_{czz}	324	314	294	260	220	182	151	106	77.6	58.9	46.1	37.0	30.4
			P_{cy}	336	265	204	156	122	96.7	78.2	53.8	39.2	29.7	23.3	18.8	15.5
	* 8.0	16.9	P_{cx}	588	493	405	328	265	216	178	125	92.9	71.2	56.3	45.5	37.6
			P_{czz}	561	535	477	401	326	263	214	147	106	80.5	62.8	50.3	41.2
			P_{cy}	509	386	286	213	163	128	102	70.1	50.7	38.4	30.0	24.1	19.8
	* 10.0	20.4	P_{cx}	817	676	546	436	349	282	231	161	119	91.0	71.7	57.9	47.8
			P_{czz}	830	771	666	544	433	345	278	189	136	102	79.7	63.7	52.1
			P_{cy}	688	502	362	265	201	156	124	84.6	61.0	46.0	35.9	28.8	23.6
	12.0	23.7	P_{cx}	1010	829	668	532	425	343	281	196	144	110	86.9	70.2	57.9
			P_{czz}	1060	966	826	670	531	421	339	230	165	124	96.6	77.3	63.2
			P_{cy}	826	593	422	307	231	179	142	96.6	69.5	52.4	40.9	32.8	26.9
200 x 100	* 8.0	23.2	P_{cx}	720	645	573	504	439	380	328	247	189	149	119	98.2	81.9
			P_{czz}	581	573	559	534	495	445	391	295	224	174	138	111	92.3
			P_{cy}	664	565	472	388	318	261	216	154	114	88.0	69.7	56.5	46.7
	* 10.0	28.3	P_{cx}	1030	910	799	693	596	509	436	323	245	192	153	125	104
			P_{czz}	895	880	849	791	710	620	533	391	291	224	176	142	117
			P_{cy}	932	777	633	509	409	332	272	191	141	108	85.3	69.0	56.9
	* 12.0	33.2	P_{cx}	1350	1190	1040	891	758	643	546	400	303	235	188	153	127
			P_{czz}	1250	1220	1160	1060	928	796	675	486	359	274	215	173	142
			P_{cy}	1210	992	791	624	495	398	325	226	165	126	99.6	80.4	66.3
	15.0	40.0	P_{cx}	1850	1620	1390	1190	999	841	710	517	388	301	240	195	162
			P_{czz}	1790	1740	1620	1440	1250	1050	884	627	461	350	274	221	181
			P_{cy}	1620	1290	1010	779	609	485	393	271	198	150	118	95.4	78.5
240 x 120	* 8.0	28.2	P_{cx}	797	733	672	612	554	499	446	356	284	229	187	155	131
			P_{czz}	576	570	563	554	539	517	487	411	334	269	219	180	150
			P_{cy}	752	668	588	512	441	378	324	241	183	143	115	94.3	78.5
	* 10.0	34.6	P_{cx}	1150	1050	953	860	770	685	607	474	374	299	243	201	168
			P_{czz}	912	902	889	867	830	777	711	570	449	355	285	233	193
			P_{cy}	1070	941	814	695	588	496	420	307	231	179	143	116	96.9
	* 12.0	40.8	P_{cx}	1530	1390	1260	1130	998	880	773	596	465	369	299	246	206
			P_{czz}	1300	1280	1260	1210	1140	1040	937	729	563	440	351	285	236
			P_{cy}	1420	1230	1050	879	733	611	512	369	276	213	169	137	114
	* 15.0	49.5	P_{cx}	2160	1950	1740	1540	1360	1180	1030	783	605	478	385	316	264
			P_{czz}	1940	1910	1860	1760	1620	1450	1280	967	734	569	451	365	301
			P_{cy}	1970	1680	1400	1150	940	772	640	455	337	259	205	166	137

See Section 8.4.2 for guidance on calculating an effective length which allows for both the effects of end fixity and nominal end moments due to eccentricity of connection.

Slender sections must also be checked for the combined effects of the axial load and moment caused by the shift of neutral axis, see Section 8.4.2.

* Section is slender under axial compression and allowance has been made in calculating the compression resistance.

Table 59

COMPRESSION

**DOUBLE ANGLES BACK TO BACK
SUBJECT TO AXIAL COMPRESSION**

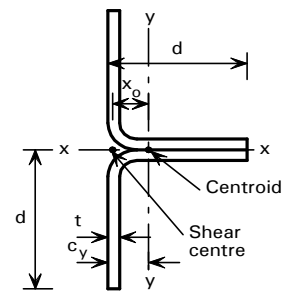

COMPRESSION RESISTANCE FOR GRADE 1.4362 (SAF 2304)

2d x d mm	t mm	Mass per Metre kg	Axis	Compression Resistance, P_{cx} , P_{cxz} , P_{cy} (kN)												
				for Effective Length L_E (m)												
				1.0	1.5	2.0	2.5	3.0	3.5	4.0	5.0	6.0	7.0	8.0	9.0	10.0
300 x 150	* 8.0	35.8	P_{cx}	850	829	779	731	684	638	593	507	430	363	307	262	225
			P_{cxz}	554	547	542	538	532	526	517	491	451	401	348	300	258
			P_{cy}	846	780	716	654	593	535	481	384	308	249	204	170	143
	* 10.0	44.1	P_{cx}	1260	1210	1130	1050	975	902	831	698	582	485	406	343	293
			P_{cxz}	907	897	889	880	869	853	830	761	667	568	478	403	342
			P_{cy}	1230	1120	1020	920	824	733	649	507	399	319	259	214	180
	* 12.0	52.2	P_{cx}	1710	1620	1510	1400	1290	1190	1080	898	739	610	507	426	362
			P_{cxz}	1320	1310	1300	1280	1260	1230	1180	1040	881	731	606	505	425
			P_{cy}	1650	1500	1350	1200	1060	933	817	627	488	386	312	257	215
	* 15.0	63.7	P_{cx}	2470	2310	2130	1960	1800	1640	1480	1210	981	801	662	553	468
			P_{cxz}	2030	2020	2000	1960	1910	1830	1720	1460	1200	974	795	656	549
			P_{cy}	2340	2100	1860	1640	1420	1230	1060	800	614	482	387	317	264
400 x 200	* 8.0	48.5	P_{cx}	903	903	898	862	827	792	759	692	628	566	508	454	406
			P_{cxz}	505	492	487	484	482	479	477	470	462	451	437	418	396
			P_{cy}	903	900	852	807	762	719	676	592	514	444	383	331	287
	* 10.0	59.9	P_{cx}	1350	1350	1320	1260	1210	1150	1100	989	886	789	699	618	546
			P_{cxz}	862	845	837	832	827	822	816	801	779	749	707	656	599
			P_{cy}	1350	1320	1250	1170	1100	1030	957	823	702	596	507	433	372
	* 12.0	71.1	P_{cx}	1860	1860	1800	1710	1630	1550	1470	1310	1160	1020	898	787	691
			P_{cxz}	1300	1280	1270	1260	1250	1240	1230	1200	1150	1080	994	895	797
			P_{cy}	1860	1800	1680	1570	1470	1360	1260	1060	892	748	629	533	456
	* 15.0	87.4	P_{cx}	2730	2730	2600	2460	2330	2210	2080	1840	1600	1390	1210	1050	913
			P_{cxz}	2080	2060	2040	2030	2010	1990	1970	1890	1770	1610	1430	1250	1090
			P_{cy}	2730	2590	2410	2230	2060	1890	1730	1430	1180	972	809	680	577

See Section 8.4.2 for guidance on calculating an effective length which allows for both the effects of end fixity and nominal end moments due to eccentricity of connection.

Slender sections must also be checked for the combined effects of the axial load and moment caused by the shift of neutral axis, see Section 8.4.2.

* Section is slender under axial compression and allowance has been made in calculating the compression resistance.

Table 60

TENSION

**EQUAL ANGLES
SUBJECT TO AXIAL TENSION**

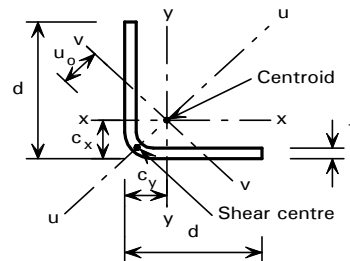

TENSION CAPACITY FOR GRADE 1.4362 (SAF 2304)

d x d mm	t mm	Mass per Metre kg	Radius of Gyration v-v axis cm	Gross Area cm ²	Weld or Bolt Size	Holes Deducted From Angle		Equivalent Tension Area cm ²	Tension Capacity kN
						No.	Diameter mm		
50 x 50	5.0	3.54	0.892	4.48	Weld	0	-	3.89	155
					M12	1	13	2.84	113
50 x 50	6.0	4.15	0.861	5.25	Weld	0	-	4.58	183
					M12	1	13	3.35	133
50 x 50	8.0	5.27	0.797	6.67	Weld	0	-	5.87	234
					M12	1	13	4.30	171
50 x 50	10.0	6.26	0.732	7.93	Weld	0	-	7.05	281
					M12	1	13	5.16	206
75 x 75	6.0	6.52	1.38	8.25	Weld	0	-	7.13	285
					M16	1	18	5.30	211
					M20	1	22	5.06	202
75 x 75	8.0	8.43	1.32	10.7	Weld	0	-	9.27	370
					M16	1	18	6.90	275
					M20	1	22	6.58	263
75 x 75	10.0	10.2	1.26	12.9	Weld	0	-	11.3	451
					M16	1	18	8.41	336
					M20	1	22	8.01	320
75 x 75	12.0	11.9	1.20	15.0	Weld	0	-	13.2	528
					M16	1	18	9.85	393
					M20	1	22	9.37	374
100 x 100	8.0	11.6	1.84	14.7	Weld	0	-	12.7	506
					M20	1	22	9.58	383
					M24	1	26	9.26	370
100 x 100	10.0	14.2	1.78	17.9	Weld	0	-	15.5	621
					M20	1	22	11.8	470
					M24	1	26	11.4	454
100 x 100	12.0	16.6	1.72	21.0	Weld	0	-	18.3	732
					M20	1	22	13.9	554
					M24	1	26	13.4	535
100 x 100	15.0	20.0	1.63	25.3	Weld	0	-	22.2	889
					M20	1	22	16.9	674
					M24	1	26	16.3	650
120 x 120	8.0	14.1	2.25	17.9	Weld	0	-	15.4	615
					M20	1	22	12.0	479
					M24	1	26	11.7	466
120 x 120	10.0	17.3	2.20	21.9	Weld	0	-	18.9	757
					M20	1	22	14.8	590
					M24	1	26	14.4	574
120 x 120	12.0	20.4	2.14	25.8	Weld	0	-	22.4	895
					M20	1	22	17.5	698
					M24	1	26	17.0	679
120 x 120	15.0	24.8	2.05	31.3	Weld	0	-	27.3	1090
					M20	1	22	21.4	854
					M24	1	26	20.8	830
150 x 150	8.0	17.9	2.87	22.7	Weld	0	-	19.5	778
					M20	1	22	15.6	623
					M20	2	22	13.8	552
					M24	1	26	15.3	610
150 x 150	10.0	22.1	2.82	27.9	Weld	0	-	24.0	961
					M20	1	22	19.3	770
					M20	2	22	17.1	682
					M24	1	26	18.9	754

The capacity of the bolts must also be checked.

For explanation of table see Section 8.5

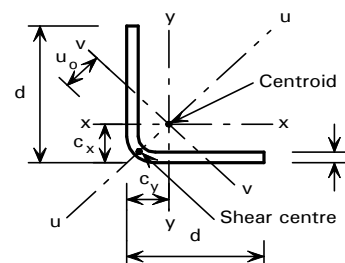
Table 60**TENSION****EQUAL ANGLES
SUBJECT TO AXIAL TENSION****TENSION CAPACITY FOR GRADE 1.4362 (SAF 2304)**

d x d mm	t mm	Mass per Metre kg	Radius of Gyration v-v axis cm	Gross Area cm ²	Weld or Bolt Size	Holes Deducted From Angle		Equivalent Tension Area cm ²	Tension Capacity kN
						No.	Diameter mm		
150 x 150	12.0	26.1	2.76	33.0	Weld	0	-	28.5	1140
					M20	1	22	22.9	914
					M20	2	22	20.2	809
					M24	1	26	22.4	895
150 x 150	15.0	31.9	2.67	40.3	Weld	0	-	35.0	1400
					M20	1	22	28.1	1120
					M20	2	22	24.8	992
					M24	1	26	27.5	1100
200 x 200	8.0	24.2	3.90	30.7	Weld	0	-	26.3	1050
					M20	3	22	18.1	722
					M24	1	26	21.3	850
					M24	2	26	19.2	767
200 x 200	10.0	30.0	3.85	37.9	Weld	0	-	32.5	1300
					M20	3	22	22.4	894
					M24	1	26	26.4	1050
					M24	2	26	23.8	950
200 x 200	12.0	35.6	3.79	45.0	Weld	0	-	38.7	1550
					M20	3	22	26.6	1060
					M24	1	26	31.4	1260
					M24	2	26	28.3	1130
200 x 200	15.0	43.7	3.71	55.3	Weld	0	-	47.7	1910
					M20	3	22	32.8	1310
					M24	1	26	38.8	1550
					M24	2	26	34.9	1390

The capacity of the bolts must also be checked.

For explanation of table see Section 8.5

Table 61

TENSION
TWO EQUAL ANGLES
BACK TO BACK
SUBJECT TO AXIAL TENSION

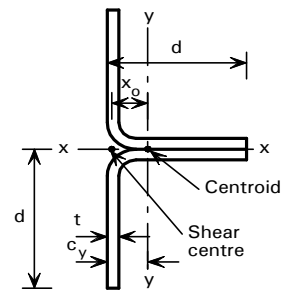

TENSION CAPACITY FOR GRADE 1.4362 (SAF 2304)

2d x d mm	t mm	Mass per Metre kg	Radius of Gyration		Gross Area cm ²	Weld or Bolt Size	Holes Deducted From Angle		Gusset Between Angles		Gusset On Back of Angles	
			Axis x-x cm	Axis y-y cm			No.	Diameter mm	Equivalent Tension Area cm ²	Tension Capacity kN	Equivalent Tension Area cm ²	Tension Capacity kN
100 x 50	5.0	7.08	2.17	1.55	8.96	Weld M12	0	-	8.37	334	7.77	310
							1	13	6.67	266	5.68	227
100 x 50	6.0	8.30	2.20	1.53	10.5	Weld M12	0	-	9.83	393	9.16	366
							1	13	7.82	312	6.69	267
100 x 50	8.0	10.5	2.26	1.50	13.3	Weld M12	0	-	12.5	501	11.7	469
							1	13	9.93	397	8.59	343
100 x 50	10.0	12.5	2.34	1.47	15.9	Weld M12	0	-	15.0	599	14.1	563
							1	13	11.8	471	10.3	413
150 x 75	6.0	13.0	3.21	2.34	16.5	Weld M16	0	-	15.4	615	14.3	570
							1	18	12.5	498	10.6	423
							1	22	12.0	479	10.1	404
150 x 75	8.0	16.9	3.27	2.31	21.3	Weld M16	0	-	19.9	797	18.5	741
							1	18	16.1	645	13.8	551
							1	22	15.5	619	13.2	526
150 x 75	10.0	20.4	3.33	2.28	25.9	Weld M16	0	-	24.2	969	22.6	903
							1	18	19.5	781	16.8	673
							1	22	18.7	749	16.0	641
150 x 75	12.0	23.7	3.40	2.25	30.0	Weld M16	0	-	28.2	1130	26.4	1060
							1	18	22.7	908	19.7	787
							1	22	21.7	869	18.7	749
200 x 100	8.0	23.2	4.28	3.12	29.3	Weld M20	0	-	27.3	1090	25.3	1010
							1	22	22.5	899	19.2	766
							1	26	21.8	873	18.5	740
200 x 100	10.0	28.3	4.33	3.09	35.9	Weld M20	0	-	33.5	1340	31.1	1240
							1	22	27.5	1100	23.5	941
							1	26	26.7	1070	22.7	909
200 x 100	12.0	33.2	4.40	3.06	42.0	Weld M20	0	-	39.3	1570	36.6	1460
							1	22	32.2	1290	27.7	1110
							1	26	31.3	1250	26.8	1070
200 x 100	15.0	40.0	4.49	3.02	50.7	Weld M20	0	-	47.6	1900	44.5	1780
							1	22	38.9	1560	33.7	1350
							1	26	37.7	1510	32.5	1300
240 x 120	8.0	28.2	5.09	3.77	35.7	Weld M20	0	-	33.3	1330	30.8	1230
							1	22	28.1	1120	24.0	958
							1	26	27.4	1100	23.3	932
240 x 120	10.0	34.6	5.14	3.74	43.9	Weld M20	0	-	40.9	1640	37.9	1520
							1	22	34.5	1380	29.5	1180
							1	26	33.7	1350	28.7	1150
240 x 120	12.0	40.8	5.20	3.71	51.6	Weld M20	0	-	48.2	1930	44.8	1790
							1	22	40.6	1630	34.9	1400
							1	26	39.7	1590	34.0	1360
240 x 120	15.0	49.5	5.29	3.67	62.7	Weld M20	0	-	58.7	2350	54.7	2190
							1	22	49.4	1980	42.7	1710
							1	26	48.2	1930	41.5	1660
300 x 150	8.0	35.8	6.31	4.74	45.3	Weld M20	0	-	42.1	1690	38.9	1560
							1	22	36.5	1460	31.2	1250
							2	22	33.0	1320	27.6	1110
							1	26	35.8	1430	30.5	1220
300 x 150	10.0	44.1	6.36	4.71	55.9	Weld M20	0	-	52.0	2080	48.1	1920
							1	22	45.0	1800	38.5	1540
							2	22	40.6	1620	34.1	1370
							1	26	44.2	1770	37.7	1510

The capacity of the bolts must also be checked.

For explanation of table see Section 8.5

[Discuss me ...](#)

Table 61

TENSION
TWO EQUAL ANGLES
BACK TO BACK
SUBJECT TO AXIAL TENSION

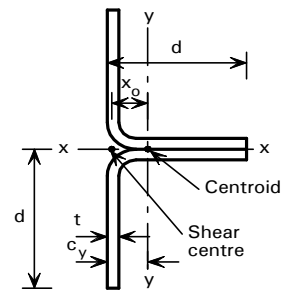

TENSION CAPACITY FOR GRADE 1.4362 (SAF 2304)

2d x d mm	t mm	Mass per Metre kg	Radius of Gyration		Gross Area cm ²	Weld or Bolt Size	Holes Deducted From Angle		Gusset Between Angles		Gusset On Back of Angles	
			Axis x-x cm	Axis y-y cm			No.	Diameter mm	Equivalent Tension Area cm ²	Tension Capacity kN	Equivalent Tension Area cm ²	Tension Capacity kN
300 x 150	12.0	52.2	6.42	4.68	66.0	Weld	0	-	61.5	2460	57.0	2280
						M20	1	22	53.2	2130	45.7	1830
						M20	2	22	48.0	1920	40.5	1620
						M24	1	26	52.3	2090	44.8	1790
300 x 150	15.0	63.7	6.50	4.64	80.7	Weld	0	-	75.3	3010	70.0	2800
						M20	1	22	65.2	2610	56.2	2250
						M20	2	22	58.6	2340	49.6	1990
						M24	1	26	64.0	2560	55.0	2200
400 x 200	8.0	48.5	8.35	6.35	61.3	Weld	0	-	56.9	2280	52.5	2100
						M20	3	22	43.4	1740	36.1	1440
						M24	1	26	49.8	1990	42.5	1700
						M24	2	26	45.7	1830	38.4	1530
400 x 200	10.0	59.9	8.40	6.32	75.9	Weld	0	-	70.5	2820	65.1	2600
						M20	3	22	53.7	2150	44.7	1790
						M24	1	26	61.7	2470	52.7	2110
						M24	2	26	56.5	2260	47.5	1900
400 x 200	12.0	71.1	8.45	6.30	90.0	Weld	0	-	83.7	3350	77.4	3100
						M20	3	22	63.7	2550	53.2	2130
						M24	1	26	73.3	2930	62.8	2510
						M24	2	26	67.0	2680	56.5	2260
400 x 200	15.0	87.4	8.53	6.26	110	Weld	0	-	103	4120	95.5	3820
						M20	3	22	78.2	3130	65.5	2620
						M24	1	26	90.2	3610	77.5	3100
						M24	2	26	82.4	3300	69.7	2790

The capacity of the bolts must also be checked.

For explanation of table see Section 8.5

Table 62

BENDING

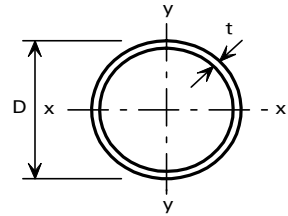
CIRCULAR HOLLOW SECTIONS
SUBJECT TO BENDING

MOMENT AND SHEAR CAPACITY FOR GRADE 1.4362 (SAF 2304)

D mm	t mm	Mass per Metre kg	Section Classification	Moment Capacity M_c kNm	Second Moment Of Area I_x, I_y cm ⁴	Shear Capacity P_v kN
21.3	1.0	0.50	Plastic	<i>0.148</i>	0.329	9.18
	1.2	0.60	Plastic	<i>0.173</i>	0.384	10.9
	1.6	0.78	Plastic	<i>0.218</i>	0.484	14.3
	2.0	0.96	Plastic	<i>0.257</i>	0.571	17.5
	2.3	1.08	Plastic	<i>0.283</i>	0.629	19.8
33.7	1.0	0.81	Compact	<i>0.392</i>	1.37	14.8
	1.6	1.27	Plastic	<i>0.593</i>	2.08	23.2
	2.0	1.57	Plastic	<i>0.716</i>	2.51	28.7
	2.5	1.94	Plastic	<i>0.855</i>	3.00	35.3
	3.2	2.42	Plastic	<i>1.03</i>	3.60	44.2
42.4	1.0	1.03	Semi-compact	<i>0.526</i>	2.79	18.7
	1.6	1.62	Plastic	<i>0.968</i>	4.27	29.5
	2.0	2.01	Plastic	<i>1.18</i>	5.19	36.6
	2.6	2.57	Plastic	<i>1.46</i>	6.46	46.8
	3.2	3.11	Plastic	<i>1.73</i>	7.62	56.7
48.3	1.0	1.17	Semi-compact	<i>0.689</i>	4.16	21.4
	1.6	1.85	Compact	<i>1.27</i>	6.41	33.8
	2.0	2.30	Plastic	<i>1.55</i>	7.81	41.9
	2.6	2.95	Plastic	<i>1.94</i>	9.78	53.8
	3.2	3.58	Plastic	<i>2.30</i>	11.6	65.3
60.3	1.0	1.47	Semi-compact	<i>1.09</i>	8.19	26.8
	1.6	2.33	Compact	<i>2.02</i>	12.7	42.5
	2.0	2.89	Compact	<i>2.48</i>	15.6	52.7
	2.6	3.72	Plastic	<i>3.13</i>	19.7	67.9
	3.2	4.53	Plastic	<i>3.74</i>	23.5	82.7
	4.0	5.59	Plastic	<i>4.49</i>	28.2	101
	5.0	6.86	Plastic	<i>5.33</i>	33.5	125
76.1	1.0	1.86	Semi-compact	<i>1.75</i>	16.6	34.0
	1.6	2.96	Semi-compact	<i>2.73</i>	26.0	53.9
	2.0	3.68	Compact	<i>4.03</i>	32.0	67.0
	2.6	4.74	Compact	<i>5.12</i>	40.6	86.5
	3.2	5.79	Plastic	<i>6.15</i>	48.8	105
	4.0	7.16	Plastic	<i>7.45</i>	59.1	130
	5.0	8.82	Plastic	<i>8.95</i>	70.9	160
88.9	1.0	2.18	Semi-compact	<i>2.40</i>	26.7	39.8
	1.6	3.47	Semi-compact	<i>3.76</i>	41.8	63.2
	2.0	4.31	Semi-compact	<i>4.64</i>	51.6	78.6
	2.6	5.57	Compact	<i>7.09</i>	65.7	101
	3.2	6.81	Compact	<i>8.55</i>	79.2	124
	4.0	8.43	Plastic	<i>10.4</i>	96.3	153
	5.0	10.4	Plastic	<i>12.6</i>	116	189
101.6	1.0	2.50	Semi-compact	<i>3.15</i>	40.0	45.5
	1.6	3.97	Semi-compact	<i>4.95</i>	62.8	72.4
	2.0	4.94	Semi-compact	<i>6.11</i>	77.6	90.1
	2.6	6.39	Semi-compact	<i>7.81</i>	99.1	116
	3.2	7.81	Compact	<i>11.3</i>	119	142
	4.0	9.69	Plastic	<i>13.8</i>	146	176
	5.0	12.0	Plastic	<i>16.8</i>	177	218

M_c values in *italic type* are governed by $1.2p_y Z$ and a higher value may be used in some circumstances.

For explanation of table see Section 8.6.

Table 62

BENDING

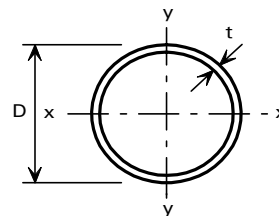
CIRCULAR HOLLOW SECTIONS
SUBJECT TO BENDING

MOMENT AND SHEAR CAPACITY FOR GRADE 1.4362 (SAF 2304)

D mm	t mm	Mass per Metre kg	Section Classification	Moment Capacity M_c kNm	Second Moment Of Area I_x, I_y cm ⁴	Shear Capacity P_v kN
114.3	1.2	3.37	Semi-compact	4.77	68.2	61.4
	1.6	4.48	Semi-compact	6.30	90.0	81.6
	2.0	5.57	Semi-compact	7.79	111	101
	2.6	7.21	Semi-compact	9.96	142	131
	3.2	8.82	Compact	14.5	172	160
	4.0	10.9	Compact	17.7	211	199
	5.0	13.6	Plastic	21.6	256	247
139.7	1.2	4.12	Semi-compact	7.17	125	75.2
	1.6	5.48	Semi-compact	9.48	165	100
	2.0	6.84	Semi-compact	11.7	205	124
	2.6	8.85	Semi-compact	15.1	263	161
	3.2	10.8	Semi-compact	18.3	319	197
	4.0	13.5	Compact	27.0	392	245
	5.0	16.7	Compact	33.0	480	304
168.3	1.6	6.62	Semi-compact	13.8	291	120
	2.0	8.25	Semi-compact	17.2	361	150
	2.6	10.7	Semi-compact	22.1	464	194
	3.2	13.1	Semi-compact	26.9	565	239
	4.0	16.3	Semi-compact	33.1	697	297
	5.0	20.3	Compact	48.8	855	369
219.1	2.0	10.8	Semi-compact	29.3	803	196
	2.6	14.0	Semi-compact	37.8	1040	254
	3.2	17.1	Semi-compact	46.2	1260	312
	4.0	21.4	Semi-compact	57.1	1560	389
	5.0	26.6	Semi-compact	70.4	1930	484
273	2.6	17.4	Semi-compact	59.2	2020	318
	3.2	21.4	Semi-compact	72.3	2470	390
	4.0	26.7	Semi-compact	89.6	3060	486
	5.0	33.3	Semi-compact	110	3780	606

M_c values in *italic type* are governed by $1.2p_y Z$ and a higher value may be used in some circumstances.

For explanation of table see Section 8.6.

Table 63

BENDING

**RECTANGULAR HOLLOW SECTIONS
SUBJECT TO BENDING**

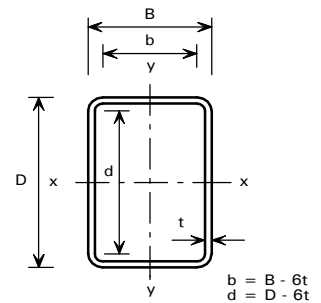

MOMENT CAPACITY AND LIMITING LENGTHS FOR GRADE 1.4362 (SAF 2304)

D x B mm	t mm	Mass per Metre kg	Section Classification		Moment Capacity		Limiting Length L _c m	Second Moment Of Area		Shear Capacity P _v kN
			Bending About x-x Axis	Bending About y-y Axis	M _{cx} kNm	M _{cy} kNm		I _x cm ⁴	I _y cm ⁴	
50 x 25	1.5	1.63	Plastic	Slender	1.23	0.650	2.54	6.41	2.19	33.0
	2.0	2.11	Plastic	Compact	1.53	1.01	2.53	7.95	2.70	42.7
60 x 30	2.0	2.58	Plastic	Slender	2.31	1.29	3.05	14.4	4.92	52.3
	3.0	3.68	Plastic	Plastic	3.05	2.06	3.01	19.1	6.44	74.5
80 x 40	2.0	3.53	Plastic	Slender	4.35	2.09	4.08	36.2	12.4	71.5
	3.0	5.10	Plastic	Semi-compact	5.97	3.38	4.05	49.7	16.9	103
	4.0	6.54	Plastic	Plastic	7.24	4.88	4.01	60.3	20.4	132
100 x 50	2.0	4.48	Compact	Slender	7.03	2.99	5.11	73.2	25.2	90.7
	3.0	6.52	Plastic	Slender	9.84	5.20	5.09	102	35.1	132
	4.0	8.43	Plastic	Compact	12.2	8.09	5.05	127	43.2	170
	5.0	10.2	Plastic	Plastic	14.1	9.54	5.01	147	49.7	206
	6.0	11.9	Plastic	Plastic	15.6	10.5	4.95	162	54.7	240
150 x 75	3.0	10.1	Compact	Slender	23.7	10.1	7.66	370	127	204
	4.0	13.2	Plastic	Slender	30.2	15.0	7.64	472	161	266
	5.0	16.1	Plastic	Slender	36.0	20.1	7.61	563	192	326
	6.0	19.0	Plastic	Compact	41.2	27.3	7.58	643	218	384
	8.0	24.2	Plastic	Plastic	49.5	33.4	7.49	774	260	491
150 x 100	3.0	11.3	Slender	Slender	22.9	14.8	23.8	451	243	205
	4.0	14.8	Compact	Slender	37.1	21.9	15.0	578	311	268
	5.0	18.1	Plastic	Slender	44.5	29.3	15.0	694	373	330
	6.0	21.3	Plastic	Compact	51.2	40.1	15.1	799	428	389
	8.0	27.4	Plastic	Plastic	62.5	50.0	15.1	976	521	499
200 x 100	4.0	17.9	Compact	Slender	56.3	23.9	10.2	1170	403	362
	5.0	22.1	Plastic	Slender	68.0	32.6	10.2	1420	485	446
	6.0	26.1	Plastic	Slender	78.7	41.6	10.2	1640	561	528
	8.0	33.7	Plastic	Compact	97.6	64.7	10.1	2030	690	683
	10.0	40.8	Plastic	Plastic	113	76.3	10.0	2360	795	827
200 x 125	4.0	19.5	Slender	Slender	53.1	32.2	26.1	1360	666	364
	5.0	24.0	Compact	Slender	79.4	43.7	16.9	1650	805	449
	6.0	28.5	Plastic	Slender	92.3	55.7	17.0	1920	935	531
	8.0	36.9	Plastic	Compact	115	87.1	17.0	2400	1160	689
	10.0	44.8	Plastic	Plastic	134	103	17.0	2810	1360	837
250 x 125	6.0	33.2	Plastic	Slender	128	60.2	12.7	3340	1150	672
	8.0	43.2	Plastic	Slender	161	88.4	12.7	4210	1440	875
	10.0	52.7	Plastic	Compact	190	126	12.6	4970	1690	1070
	12.0	61.7	Plastic	Plastic	215	144	12.5	5610	1900	1250
	15.0	74.1	Plastic	Plastic	244	164	12.4	6360	2140	1500
250 x 150	6.0	35.6	Compact	Slender	145	76.5	19.2	3790	1730	675
	8.0	46.4	Plastic	Slender	184	112	19.2	4800	2190	880
	10.0	56.6	Plastic	Compact	218	161	19.2	5690	2580	1080
	12.0	66.4	Plastic	Plastic	247	185	19.2	6460	2930	1260
	15.0	80.1	Plastic	Plastic	284	213	19.1	7400	3340	1520
300 x 150	6.0	40.3	Compact	Slender	189	80.7	15.3	5930	2040	816
	8.0	52.7	Plastic	Slender	241	120	15.3	7560	2590	1070
	10.0	64.5	Plastic	Slender	288	160	15.2	9010	3070	1310
	12.0	75.9	Plastic	Compact	329	218	15.2	10300	3500	1540
	15.0	91.9	Plastic	Plastic	381	257	15.0	11900	4030	1860
300 x 200	6.0	45.0	Slender	Slender	183	118	47.6	7230	3900	821
	8.0	59.0	Compact	Slender	296	175	29.9	9260	4990	1080
	10.0	72.4	Plastic	Slender	355	234	30.0	11100	5970	1320
	12.0	85.4	Plastic	Compact	409	320	30.1	12800	6850	1560
	15.0	103	Plastic	Plastic	479	381	30.2	15000	8000	1890

Moment capacity values in *italic type* are governed by 1.2p_yZ and a higher value may be used in some circumstances.

Lengths above the limiting length L_c should be checked for lateral torsional buckling.

For explanation of table see Section 8.6.

Table 63

BENDING

**RECTANGULAR HOLLOW SECTIONS
SUBJECT TO BENDING**

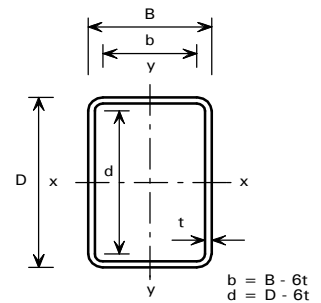

MOMENT CAPACITY AND LIMITING LENGTHS FOR GRADE 1.4362 (SAF 2304)

D x B mm	t mm	Mass per Metre kg	Section Classification		Moment Capacity		Limiting Length L _c m	Second Moment Of Area		Shear Capacity P _v kN
			Bending About x-x Axis	Bending About y-y Axis	M _{cx} kNm	M _{cy} kNm		I _x cm ⁴	I _y cm ⁴	
350 x 175	6.0	47.4	Slender	Slender	218	103	27.4	9600	3320	960
	8.0	62.2	Plastic	Slender	337	154	17.9	12300	4240	1260
	10.0	76.4	Plastic	Slender	405	209	17.8	14800	5070	1550
	12.0	90.1	Plastic	Slender	467	264	17.8	17100	5810	1820
	15.0	109	Plastic	Plastic	548	365	17.6	20000	6780	2220
350 x 200	6.0	49.8	Slender	Slender	228	123	38.9	10500	4460	962
	8.0	65.3	Compact	Slender	370	184	24.0	13500	5720	1260
	10.0	80.3	Plastic	Slender	445	248	24.0	16200	6870	1550
	12.0	94.8	Plastic	Slender	514	315	24.0	18800	7920	1830
	15.0	115	Plastic	Plastic	606	436	23.9	22100	9290	2240
400 x 200	6.0	54.5	Slender	Slender	270	127	35.7	14500	5030	1100
	8.0	71.6	Compact	Slender	450	191	20.4	18800	6460	1450
	10.0	88.2	Plastic	Slender	543	260	20.4	22700	7780	1790
	12.0	104	Plastic	Slender	629	332	20.3	26200	8980	2110
	15.0	127	Plastic	Semi-compact	745	423	20.2	31100	10600	2580
400 x 250	6.0	59.3	Slender	Slender	286	172	67.4	16900	8250	1110
	8.0	78.0	Slender	Slender	424	257	52.1	21800	10700	1460
	10.0	96.1	Compact	Slender	634	349	33.9	26500	12900	1800
	12.0	113	Plastic	Slender	738	445	33.9	30800	15000	2130
	15.0	139	Plastic	Semi-compact	879	568	34.0	36600	17800	2600

Moment capacity values in *italic type* are governed by 1.2p_yZ and a higher value may be used in some circumstances.

Lengths above the limiting length L_c should be checked for lateral torsional buckling.

For explanation of table see Section 8.6.

Table 64

BENDING

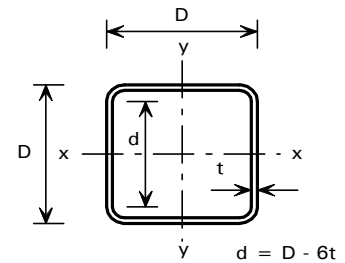
SQUARE HOLLOW SECTIONS
SUBJECT TO BENDING

MOMENT AND SHEAR CAPACITY FOR GRADE 1.4362 (SAF 2304)

D x D mm	t mm	Mass per Metre kg	Section Classification	Moment Capacity M_c kNm	Second Moment Of Area I_x, I_y cm ⁴	Shear Capacity P_v kN
40 x 40	2.0	2.27	Plastic	<i>1.60</i>	6.66	34.4
	3.0	3.20	Plastic	<i>2.09</i>	8.69	48.6
50 x 50	2.0	2.90	Compact	2.60	13.7	44.0
	3.0	4.15	Plastic	3.55	18.5	63.0
	4.0	5.27	Plastic	4.22	22.0	80.1
60 x 60	2.0	3.53	Slender	3.22	24.5	53.6
	3.0	5.10	Plastic	5.39	33.7	77.4
	4.0	6.54	Plastic	6.56	41.0	99.3
	5.0	7.84	Plastic	<i>7.44</i>	46.5	119
80 x 80	2.0	4.79	Slender	5.26	60.6	72.8
	3.0	6.99	Semi-compact	8.53	85.3	106
	4.0	9.06	Plastic	12.8	106	137
	5.0	11.0	Plastic	14.9	124	167
100 x 100	3.0	8.89	Slender	13.0	173	135
	4.0	11.6	Compact	20.8	219	176
	5.0	14.2	Plastic	25.0	260	215
	6.0	16.6	Plastic	28.4	295	252
	8.0	21.1	Plastic	33.7	351	320
125 x 125	3.0	11.3	Slender	19.0	348	171
	4.0	14.8	Slender	27.6	446	224
	5.0	18.1	Compact	40.6	535	275
	6.0	21.3	Plastic	47.2	616	324
	8.0	27.4	Plastic	57.8	752	416
150 x 150	3.0	13.6	Slender	25.8	613	207
	4.0	17.9	Slender	37.7	792	272
	5.0	22.1	Slender	50.3	957	335
	6.0	26.1	Compact	70.1	1110	396
	8.0	33.7	Plastic	88.3	1380	512
175 x 175	4.0	21.1	Slender	48.9	1280	320
	5.0	26.0	Slender	65.5	1560	395
	6.0	30.8	Slender	82.7	1820	468
	8.0	40.0	Plastic	124	2280	608
	10.0	48.7	Plastic	147	2680	740
200 x 200	4.0	24.2	Slender	61.2	1940	368
	5.0	30.0	Slender	82.2	2370	455
	6.0	35.6	Slender	104	2770	540
	8.0	46.4	Compact	166	3510	704
	10.0	56.6	Plastic	199	4160	860
250 x 250	5.0	37.9	Slender	119	4740	575
	6.0	45.0	Slender	152	5570	684
	8.0	59.0	Slender	221	7140	896
	10.0	72.4	Compact	324	8570	1100
	12.0	85.4	Plastic	377	9860	1300
300 x 300	5.0	45.8	Slender	161	8320	695
	6.0	54.5	Slender	206	9820	828
	8.0	71.6	Slender	301	12700	1090
	10.0	88.2	Slender	402	15300	1340
	12.0	104	Compact	560	17800	1580
350 x 350	6.0	64.0	Slender	266	15800	972
	8.0	84.3	Slender	391	20500	1280
	10.0	104	Slender	524	24900	1580
	12.0	123	Slender	661	29100	1870
	15.0	151	Plastic	943	34700	2300

M_c values in *italic type* are governed by $1.2p_y Z$ and a higher value may be used in some circumstances.

For explanation of table see Section 8.6.

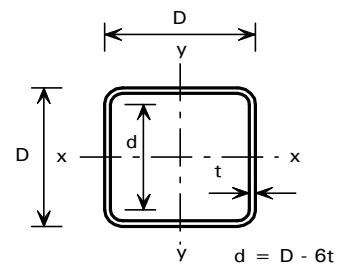
Table 64**BENDING****SQUARE HOLLOW SECTIONS
SUBJECT TO BENDING****MOMENT AND SHEAR CAPACITY FOR GRADE 1.4362 (SAF 2304)**

D x D mm	t mm	Mass per Metre kg	Section Classification	Moment Capacity M_c kNm	Second Moment Of Area I_x, I_y cm^4	Shear Capacity P_v kN
400 x 400	6.0	73.5	Slender	314	23900	1120
	8.0	96.9	Slender	489	31000	1470
	10.0	119	Slender	657	37900	1820
	12.0	142	Slender	833	44300	2160
	15.0	174	Semi-compact	1070	53300	2660

M_c values in *italic type* are governed by $1.2p_y Z$ and a higher value may be used in some circumstances.

For explanation of table see Section 8.6.

Table 65

BENDING

**CHANNELS
SUBJECT TO BENDING**

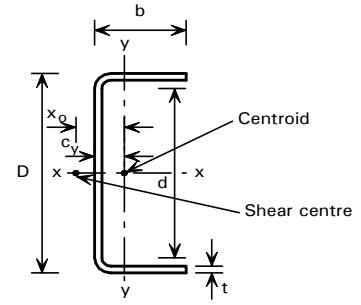

MOMENT CAPACITY AND BUCKLING RESISTANCE MOMENT FOR GRADE 1.4362 (SAF 2304)

D x b mm	t mm	Section Classification	Moment Capacity		Buckling Resistance Moment, M _b (kNm)													Shear Capacity P _v kN
			M _{cx} kNm	M _{cy} kNm	for Effective lengths, L _E (m)													
					1.0	1.5	2.0	2.5	3.0	3.5	4.0	5.0	6.0	7.0	8.0	9.0	10.0	
50 x 25	2.0	Slender	0.959	0.149	0.563	0.393	0.300	0.243	0.205	0.177	0.156	0.126	0.106	0.091	0.080	0.072	0.065	24.0
	3.0	Semi-compact	1.48	0.360	0.985	0.743	0.588	0.485	0.413	0.360	0.318	0.259	0.219	0.189	0.167	0.149	0.135	36.0
75 x 35	3.0	Slender	3.15	0.486	2.32	1.70	1.31	1.07	0.897	0.776	0.683	0.553	0.465	0.401	0.353	0.316	0.285	54.0
	4.0	Semi-compact	4.33	0.959	3.31	2.58	2.06	1.71	1.46	1.27	1.13	0.918	0.775	0.671	0.592	0.530	0.480	72.0
	5.0	Compact	6.02	1.39	4.70	3.72	3.01	2.51	2.15	1.88	1.67	1.36	1.15	0.999	0.881	0.789	0.714	90.0
100 x 50	3.0	Slender	5.40	0.647	4.79	3.86	3.01	2.41	1.99	1.70	1.48	1.18	0.982	0.843	0.739	0.659	0.595	72.0
	4.0	Slender	7.68	1.19	6.76	5.56	4.50	3.71	3.14	2.72	2.40	1.94	1.64	1.41	1.25	1.11	1.01	96.0
	5.0	Slender	9.97	2.06	8.79	7.42	6.18	5.22	4.49	3.93	3.50	2.86	2.42	2.10	1.86	1.66	1.51	120
125 x 50	3.0	Slender	7.47	0.641	6.50	5.02	3.74	2.89	2.33	1.95	1.68	1.32	1.09	0.928	0.811	0.720	0.648	90.0
	4.0	Slender	10.6	1.22	9.09	7.12	5.49	4.38	3.63	3.10	2.71	2.16	1.81	1.55	1.36	1.22	1.10	120
	5.0	Slender	13.7	2.13	11.7	9.42	7.49	6.13	5.17	4.47	3.94	3.18	2.68	2.31	2.04	1.82	1.65	150
	6.0	Semi-compact	16.3	2.99	14.1	11.7	9.60	8.03	6.87	6.00	5.32	4.34	3.67	3.18	2.81	2.51	2.27	180
150 x 60	4.0	Slender	14.7	1.38	13.5	11.3	8.94	7.09	5.79	4.88	4.21	3.31	2.73	2.33	2.03	1.81	1.63	144
	5.0	Slender	19.2	2.32	17.5	14.7	11.9	9.64	8.04	6.88	6.01	4.81	4.01	3.45	3.03	2.70	2.44	180
	6.0	Slender	23.7	3.69	21.6	18.3	15.1	12.5	10.6	9.17	8.09	6.54	5.50	4.75	4.19	3.74	3.38	216
	8.0	Compact	36.4	6.79	33.3	28.1	23.4	19.8	17.0	14.9	13.2	10.8	9.14	7.93	7.00	6.27	5.68	288
175 x 60	5.0	Slender	24.0	2.36	21.8	17.9	14.0	11.1	9.09	7.69	6.66	5.26	4.36	3.73	3.26	2.90	2.62	210
	6.0	Slender	29.6	3.76	26.7	22.1	17.6	14.3	11.9	10.2	8.92	7.14	5.97	5.14	4.51	4.02	3.63	252
	8.0	Compact	45.7	6.96	41.3	33.7	27.2	22.4	19.0	16.5	14.5	11.8	9.93	8.58	7.56	6.76	6.12	336
	10.0	Plastic	53.0	8.40	49.7	42.4	35.8	30.5	26.4	23.2	20.6	17.0	14.4	12.5	11.0	9.90	8.97	420
200 x 75	5.0	Slender	31.5	2.70	30.6	27.1	22.9	18.8	15.4	12.9	11.1	8.59	7.02	5.94	5.16	4.57	4.10	240
	6.0	Slender	39.2	4.13	37.8	33.5	28.4	23.5	19.7	16.7	14.5	11.5	9.48	8.10	7.08	6.30	5.67	288
	8.0	Slender	54.6	8.60	52.3	46.4	40.1	34.2	29.3	25.5	22.5	18.3	15.4	13.3	11.7	10.4	9.45	384
	10.0	Compact	78.2	13.4	75.7	66.4	57.0	48.7	42.1	36.9	32.8	26.9	22.7	19.7	17.4	15.6	14.1	480
225 x 75	6.0	Slender	46.6	4.17	44.8	39.3	32.8	26.8	22.0	18.5	15.9	12.4	10.2	8.67	7.55	6.69	6.02	324
	8.0	Slender	64.9	8.74	61.8	54.3	46.0	38.5	32.6	28.0	24.6	19.7	16.5	14.2	12.4	11.1	10.0	432
	10.0	Compact	93.2	13.7	90.0	77.7	65.1	54.6	46.5	40.4	35.7	28.9	24.3	21.0	18.5	16.6	15.0	540
	12.0	Plastic	105	15.9	103	91.6	79.3	68.4	59.6	52.6	46.9	38.6	32.7	28.4	25.2	22.6	20.4	648
250 x 100	6.0	Slender	59.8	5.13	59.8	56.9	52.0	46.2	40.2	34.6	29.9	23.1	18.7	15.6	13.5	11.8	10.6	360
	8.0	Slender	84.6	9.74	84.6	79.7	72.7	64.9	57.0	49.9	43.9	35.0	29.0	24.8	21.6	19.2	17.3	480
	10.0	Slender	109	17.1	109	102	94.0	84.6	75.4	67.0	59.9	49.0	41.4	35.7	31.5	28.2	25.5	600
	12.0	Semi-compact	130	24.0	130	122	112	103	93.5	84.6	76.8	64.2	55.0	48.0	42.6	38.2	34.7	720
300 x 100	8.0	Slender	110	9.88	110	103	93.2	81.7	70.3	60.3	52.2	40.6	33.1	27.9	24.2	21.3	19.1	576
	10.0	Slender	142	17.5	142	132	119	105	92.1	80.3	70.6	56.4	46.8	40.0	35.0	31.2	28.1	720
	12.0	Semi-compact	170	24.6	170	158	143	128	114	101	90.3	73.8	62.2	53.8	47.4	42.4	38.3	864
	15.0	Plastic	239	35.8	239	227	204	182	162	144	129	106	90.9	79.0	69.9	62.7	56.9	1080
350 x 125	8.0	Slender	149	11.4	149	147	138	128	116	103	91.2	71.2	57.3	47.6	40.6	35.4	31.4	672
	10.0	Slender	194	19.2	194	191	179	165	150	134	119	95.4	78.3	66.2	57.3	50.5	45.2	840
	12.0	Slender	240	30.5	240	235	220	203	185	167	150	122	102	87.6	76.6	68.1	61.3	1010
	15.0	Semi-compact	300	47.6	300	293	275	256	236	216	197	165	141	123	109	97.9	88.8	1260
400 x 150	8.0	Slender	192	13.7	192	192	187	178	167	154	141	114	93.1	76.8	64.8	55.9	49.0	768
	10.0	Slender	252	21.6	252	252	244	231	216	200	183	150	123	103	88.7	77.5	68.8	960
	12.0	Slender	313	33.0	313	313	302	286	267	247	227	188	157	133	116	102	91.7	1150
	15.0	Slender	406	58.1	406	406	389	368	345	321	296	251	214	185	163	145	131	1440

Section classification applies to bending about both the x-x and y-y axis.

Moment capacity values in *italic type* are governed by 1.2p_yZ and a higher value may be used in some circumstances.

M_b is obtained using an equivalent slenderness = $uv\lambda(\beta_w^{0.5})$.

In certain cases, M_b may be greater than M_{cx}, which implies that lateral torsional buckling is not critical.

For explanation of table see Section 8.6.

Table 66

BENDING

**DOUBLE CHANNELS BACK TO BACK
SUBJECT TO BENDING**

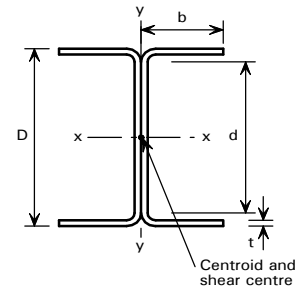

MOMENT CAPACITY AND BUCKLING RESISTANCE MOMENT FOR GRADE 1.4362 (SAF 2304)

D x 2b mm	t mm	Section Classification	Moment Capacity		Buckling Resistance Moment, M_b (kNm)														Shear Capacity P_v kN
			M_{cx} kNm	M_{cy} kNm	for Effective lengths, L_E (m)														
					1.0	1.5	2.0	2.5	3.0	3.5	4.0	5.0	6.0	7.0	8.0	9.0	10.0		
50 x 50	2.0	Slender	1.88	0.520	1.23	0.901	0.708	0.584	0.499	0.436	0.388	0.319	0.271	0.236	0.209	0.188	0.171	48.0	
	3.0	Semi-compact	2.96	1.01	2.11	1.66	1.37	1.17	1.02	0.902	0.811	0.675	0.579	0.508	0.453	0.408	0.372	72.0	
75 x 70	3.0	Slender	6.17	1.59	4.87	3.72	2.96	2.45	2.10	1.84	1.63	1.34	1.14	0.998	0.886	0.798	0.726	108	
	4.0	Slender	8.51	2.57	6.87	5.50	4.55	3.88	3.38	3.00	2.70	2.25	1.93	1.70	1.52	1.37	1.25	144	
	5.0	Semi-compact	10.0	3.34	8.55	7.16	6.15	5.38	4.78	4.29	3.90	3.30	2.86	2.53	2.27	2.05	1.88	180	
100 x 100	3.0	Slender	10.6	2.65	10.2	8.36	6.82	5.63	4.74	4.09	3.59	2.89	2.42	2.09	1.84	1.65	1.50	144	
	4.0	Slender	15.0	4.16	14.3	11.8	9.85	8.35	7.21	6.34	5.66	4.67	3.99	3.49	3.10	2.80	2.55	192	
	5.0	Slender	19.4	6.00	18.5	15.5	13.2	11.5	10.1	9.02	8.15	6.84	5.91	5.21	4.66	4.22	3.86	240	
125 x 100	3.0	Slender	14.7	2.64	13.6	10.7	8.41	6.71	5.50	4.64	4.00	3.14	2.60	2.22	1.94	1.73	1.56	180	
	4.0	Slender	20.7	4.15	18.9	15.0	12.0	9.80	8.23	7.09	6.23	5.03	4.24	3.67	3.24	2.90	2.64	240	
	5.0	Slender	26.8	6.00	24.3	19.5	16.0	13.4	11.5	10.0	8.93	7.34	6.25	5.46	4.85	4.37	3.98	300	
	6.0	Semi-compact	32.6	8.15	29.6	24.3	20.3	17.3	15.1	13.4	12.0	10.0	8.61	7.56	6.75	6.09	5.56	360	
150 x 120	4.0	Slender	28.9	5.36	28.5	23.6	19.3	15.9	13.3	11.3	9.83	7.77	6.44	5.51	4.82	4.30	3.88	288	
	5.0	Slender	37.6	7.66	36.8	30.5	25.2	21.1	17.9	15.5	13.7	11.1	9.31	8.07	7.13	6.39	5.80	360	
	6.0	Slender	46.2	10.4	45.0	37.6	31.5	26.7	23.1	20.3	18.1	14.9	12.7	11.1	9.85	8.87	8.08	432	
	8.0	Semi-compact	60.7	15.7	59.5	50.8	44.0	38.6	34.3	30.8	28.0	23.7	20.6	18.2	16.3	14.8	13.5	576	
175 x 120	5.0	Slender	47.1	7.65	45.2	36.8	29.7	24.3	20.3	17.3	15.1	12.0	10.0	8.59	7.55	6.74	6.10	420	
	6.0	Slender	57.9	10.4	55.2	45.1	36.9	30.6	26.0	22.5	19.8	16.1	13.6	11.8	10.4	9.35	8.49	504	
	8.0	Semi-compact	76.2	15.8	72.9	60.9	51.4	44.1	38.6	34.2	30.8	25.6	22.0	19.3	17.3	15.6	14.2	672	
	10.0	Plastic	106	24.0	104	87.1	74.3	64.4	56.9	50.9	46.1	38.8	33.5	29.6	26.5	24.0	21.9	840	
200 x 150	5.0	Slender	62.1	10.5	62.1	56.3	47.9	40.5	34.4	29.4	25.6	20.0	16.4	13.9	12.1	10.7	9.65	480	
	6.0	Slender	76.9	14.0	76.9	69.2	59.0	50.2	43.0	37.2	32.7	26.1	21.8	18.7	16.4	14.7	13.3	576	
	8.0	Slender	106	22.6	106	95.3	82.1	71.0	62.1	54.9	49.1	40.5	34.6	30.2	26.8	24.2	22.0	768	
	10.0	Semi-compact	130	30.7	130	118	103	91.6	81.8	73.8	67.1	56.8	49.3	43.6	39.2	35.5	32.6	960	
225 x 150	6.0	Slender	91.5	14.0	91.5	80.7	68.0	57.0	48.2	41.2	35.9	28.3	23.3	19.9	17.3	15.4	13.9	648	
	8.0	Slender	126	22.6	126	110	94.1	80.2	69.1	60.4	53.5	43.6	36.8	32.0	28.3	25.4	23.1	864	
	10.0	Semi-compact	155	30.8	155	137	118	103	91.1	81.2	73.2	61.2	52.6	46.2	41.3	37.3	34.1	1080	
	12.0	Compact	210	44.9	221	189	163	142	125	112	102	86.0	74.4	65.6	58.8	53.2	48.7	1300	
250 x 200	6.0	Slender	117	21.1	117	117	108	96.9	85.9	76.0	67.3	53.7	44.0	37.1	32.0	28.2	25.2	720	
	8.0	Slender	165	33.2	165	165	151	134	120	107	95.9	78.4	65.9	56.7	49.9	44.5	40.3	960	
	10.0	Slender	214	48.0	214	214	194	174	156	140	127	106	91.6	80.2	71.4	64.4	58.7	1200	
	12.0	Semi-compact	261	65.2	261	261	236	214	194	177	162	138	120	107	96.2	87.5	80.2	1440	
300 x 200	8.0	Slender	216	33.1	216	216	191	168	147	129	114	91.0	75.0	63.6	55.3	48.9	43.9	1150	
	10.0	Slender	279	48.0	279	276	244	216	190	169	150	122	103	89.3	78.6	70.4	63.7	1440	
	12.0	Semi-compact	341	65.4	341	335	298	264	236	211	190	158	135	118	105	95.4	86.9	1730	
	15.0	Compact	479	99.3	503	478	423	376	336	303	275	232	201	177	158	144	131	2160	
350 x 250	8.0	Slender	294	45.5	294	294	291	265	240	217	195	159	131	110	95.0	83.1	73.8	1340	
	10.0	Slender	382	64.8	382	382	375	341	309	280	253	208	174	149	130	115	103	1680	
	12.0	Slender	471	87.6	471	471	459	418	380	345	313	262	222	193	170	152	138	2020	
	15.0	Semi-compact	601	127	601	601	583	533	487	446	410	350	304	268	240	217	198	2520	
400 x 300	8.0	Slender	379	59.8	379	379	379	376	349	322	297	250	211	179	153	133	117	1540	
	10.0	Slender	496	83.7	496	496	496	486	450	416	383	324	274	235	204	179	160	1920	
	12.0	Slender	615	111	615	615	615	598	553	511	472	401	343	297	261	232	209	2300	
	15.0	Slender	793	162	793	793	793	765	710	658	609	525	456	401	357	322	293	2880	

Section classification applies to bending about both the x-x and y-y axis.

Moment capacity values in *italic type* are governed by $1.2p_y Z$ and a higher value may be used in some circumstances.

M_b is obtained using an equivalent slenderness $= \nu \lambda (\beta_w^{0.5})$.

In certain cases, M_b may be greater than M_{cx} , which implies that lateral torsional buckling is not critical.

For explanation of table see Section 8.6.

[Blank Page]

F. MEMBER CAPACITIES

GRADE 1.4462 (2205)

Note: Sections in duplex stainless steel grade 1.4462 (2205) are less widely available on an ex-stock supply basis. Before proceeding with designs it is advisable to check availability with suppliers.

Table 67

COMPRESSION

**CIRCULAR HOLLOW SECTIONS
SUBJECT TO AXIAL COMPRESSION**

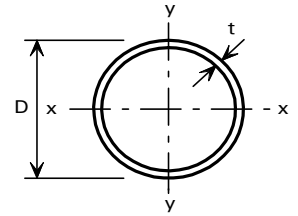

COMPRESSION RESISTANCE FOR GRADE 1.4462 (2205)

D mm	t mm	Mass per Metre kg	Compression Resistance P_c (kN)												
			for Effective Length L_e (m)												
			1.0	1.5	2.0	2.5	3.0	3.5	4.0	5.0	6.0	7.0	8.0	9.0	10.0
21.3	1.0	0.50	5.29	2.52	1.46	0.956	0.673	0.499	0.385	0.249	0.174	0.129	0.099	0.078	0.064
	1.2	0.60	6.18	2.94	1.71	1.12	0.785	0.582	0.449	0.290	0.203	0.150	0.115	0.091	0.074
	1.6	0.78	7.82	3.71	2.16	1.41	0.990	0.734	0.566	0.366	0.256	0.189	0.145	0.115	0.093
	2.0	0.96	9.26	4.39	2.55	1.66	1.17	0.867	0.668	0.432	0.302	0.223	0.171	0.136	0.110
	2.3	1.08	10.2	4.84	2.81	1.83	1.29	0.956	0.737	0.476	0.333	0.246	0.189	0.150	0.121
33.7	1.0	0.81	18.9	9.66	5.75	3.80	2.70	2.01	1.56	1.01	0.711	0.527	0.406	0.322	0.262
	1.6	1.27	29.0	14.7	8.74	5.78	4.09	3.05	2.36	1.54	1.08	0.799	0.615	0.488	0.397
	2.0	1.57	35.1	17.8	10.6	6.97	4.94	3.69	2.85	1.85	1.30	0.964	0.742	0.589	0.479
	2.5	1.94	42.2	21.3	12.6	8.35	5.91	4.41	3.41	2.22	1.56	1.15	0.887	0.704	0.572
	3.2	2.42	51.2	25.7	15.2	10.0	7.12	5.30	4.11	2.67	1.87	1.39	1.07	0.847	0.688
42.4	1.0	1.03	33.3	18.3	11.2	7.45	5.32	3.98	3.09	2.02	1.42	1.06	0.814	0.647	0.526
	1.6	1.62	51.6	28.2	17.2	11.4	8.17	6.11	4.75	3.10	2.18	1.62	1.25	0.992	0.807
	2.0	2.01	63.1	34.4	20.9	13.9	9.93	7.44	5.77	3.77	2.65	1.97	1.52	1.21	0.981
	2.6	2.57	79.4	43.0	26.1	17.4	12.4	9.27	7.20	4.70	3.31	2.45	1.89	1.50	1.22
	3.2	3.11	94.5	50.9	30.8	20.5	14.6	10.9	8.50	5.54	3.90	2.89	2.23	1.77	1.44
48.3	1.6	1.85	69.0	40.1	24.9	16.8	12.0	9.02	7.02	4.59	3.24	2.41	1.86	1.48	1.20
	2.0	2.30	84.8	49.1	30.4	20.5	14.7	11.0	8.56	5.60	3.95	2.93	2.27	1.80	1.47
	2.6	2.95	107	61.8	38.2	25.7	18.4	13.8	10.7	7.02	4.95	3.68	2.84	2.26	1.84
	3.2	3.58	128	73.6	45.4	30.5	21.8	16.4	12.7	8.33	5.87	4.36	3.37	2.68	2.18
60.3	1.6	2.33	105	70.3	45.9	31.6	22.9	17.3	13.5	8.91	6.31	4.70	3.63	2.89	2.36
	2.0	2.89	130	86.5	56.4	38.8	28.1	21.2	16.6	10.9	7.73	5.76	4.45	3.55	2.89
	2.6	3.72	166	109	71.4	49.0	35.5	26.8	21.0	13.8	9.76	7.27	5.62	4.48	3.65
	3.2	4.53	201	132	85.6	58.7	42.5	32.1	25.1	16.5	11.7	8.68	6.72	5.35	4.36
	4.0	5.59	246	159	103	70.7	51.1	38.6	30.1	19.8	14.0	10.4	8.07	6.43	5.24
5.0	6.86	298	191	123	84.3	60.9	46.0	35.9	23.6	16.7	12.4	9.60	7.64	6.23	
76.1	2.0	3.68	189	144	103	73.6	54.4	41.6	32.7	21.7	15.5	11.6	8.96	7.15	5.84
	2.6	4.74	244	185	131	93.7	69.2	52.9	41.6	27.6	19.6	14.7	11.4	9.09	7.42
	3.2	5.79	296	224	158	112	83.3	63.6	50.1	33.2	23.6	17.7	13.7	10.9	8.92
	4.0	7.16	365	274	193	137	101	77.2	60.7	40.3	28.6	21.4	16.6	13.2	10.8
	5.0	8.82	447	334	233	165	121	93.0	73.1	48.5	34.5	25.7	19.9	15.9	13.0
88.9	2.6	5.57	304	249	189	140	106	82.1	65.1	43.6	31.1	23.3	18.1	14.5	11.9
	3.2	6.81	371	302	230	170	128	99.2	78.6	52.6	37.6	28.2	21.9	17.5	14.3
	4.0	8.43	458	372	281	208	156	120	95.8	64.1	45.8	34.3	26.7	21.3	17.4
	5.0	10.4	564	456	343	253	190	146	116	77.6	55.4	41.5	32.2	25.8	21.1
101.6	2.6	6.39	364	311	251	195	151	118	94.8	64.1	46.0	34.6	27.0	21.6	17.7
	3.2	7.81	444	379	306	237	183	143	114	77.6	55.7	41.9	32.6	26.1	21.4
	4.0	9.69	550	468	377	291	224	175	140	94.8	68.1	51.2	39.8	31.9	26.1
	5.0	12.0	678	576	461	355	273	213	170	115	82.7	62.2	48.4	38.7	31.7
114.3	3.2	8.82	513	455	384	310	246	196	158	108	78.4	59.2	46.2	37.1	30.4
	4.0	10.9	637	563	474	382	303	241	194	133	96.1	72.5	56.6	45.4	37.2
	5.0	13.6	789	695	583	469	371	295	238	162	117	88.4	69.0	55.3	45.3
139.7	4.0	13.5	666	484	332	233	171	130	102	82.2	67.6	56.5	48.0	41.2	35.8
	5.0	16.7	824	596	408	286	209	159	125	100	82.7	69.2	58.7	50.5	43.8
168.3	4.0	16.3	877	702	523	383	286	220	174	141	116	97.8	83.2	71.6	62.3
	5.0	20.3	1090	868	645	472	352	271	214	173	143	120	102	88.0	76.5

Only the sections which are non slender under axial compression are given in the table.

For explanation of table see Section 8.4.

[Blank Page]

Table 68

COMPRESSION

**RECTANGULAR HOLLOW SECTIONS
SUBJECT TO AXIAL COMPRESSION**

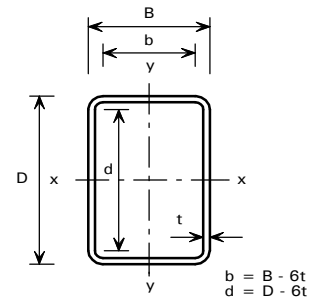

COMPRESSION RESISTANCE FOR GRADE 1.4462 (2205)

D x B mm	t mm	Mass per Metre kg	Axis	Compression Resistance, P_{cx} , P_{cy} (kN)												
				for Effective Length L_E (m)												
				1.0	1.5	2.0	2.5	3.0	3.5	4.0	5.0	6.0	7.0	8.0	9.0	10.0
50 x 25	* 1.5	1.63	P_{cx}	61.4	38.0	24.1	16.4	11.8	8.88	6.93	4.55	3.21	2.39	1.85	1.47	1.20
			P_{cy}	31.2	15.6	9.27	6.11	4.33	3.23	2.50	1.62	1.14	0.842	0.649	0.515	0.418
	2.0	2.11	P_{cx}	82.0	48.8	30.5	20.6	14.8	11.1	8.66	5.67	4.00	2.98	2.30	1.83	1.49
			P_{cy}	39.5	19.6	11.5	7.59	5.37	4.00	3.09	2.01	1.41	1.04	0.801	0.636	0.516
60 x 30	* 2.0	2.58	P_{cx}	114	77.8	51.4	35.5	25.8	19.5	15.3	10.1	7.13	5.31	4.11	3.27	2.67
			P_{cy}	65.0	33.9	20.3	13.5	9.57	7.14	5.54	3.61	2.53	1.88	1.45	1.15	0.934
	3.0	3.68	P_{cx}	163	107	69.6	47.7	34.5	26.1	20.4	13.4	9.48	7.06	5.46	4.35	3.54
			P_{cy}	88.1	45.1	26.9	17.8	12.6	9.41	7.29	4.74	3.33	2.47	1.90	1.51	1.23
80 x 40	* 2.0	3.53	P_{cx}	162	133	102	76.9	58.1	45.0	35.7	24.0	17.1	12.8	9.99	7.99	6.53
			P_{cy}	120	74.3	47.0	31.9	22.9	17.3	13.5	8.83	6.24	4.64	3.58	2.85	2.32
	3.0	5.10	P_{cx}	269	211	154	111	83.1	63.8	50.3	33.5	23.9	17.9	13.9	11.1	9.05
			P_{cy}	185	106	66.1	44.4	31.8	23.9	18.6	12.2	8.57	6.36	4.91	3.91	3.18
	4.0	6.54	P_{cx}	341	264	190	137	101	77.8	61.3	40.8	29.1	21.7	16.9	13.5	11.0
			P_{cy}	229	130	80.2	53.8	38.5	28.8	22.4	14.7	10.3	7.67	5.92	4.71	3.83
100 x 50	* 2.0	4.48	P_{cx}	195	177	152	125	101	81.4	66.1	45.5	33.0	24.9	19.5	15.6	12.8
			P_{cy}	167	122	84.7	59.7	43.8	33.3	26.2	17.3	12.3	9.19	7.12	5.68	4.63
	* 3.0	6.52	P_{cx}	342	297	245	194	152	120	96.4	65.5	47.2	35.5	27.7	22.2	18.2
			P_{cy}	276	188	124	86.1	62.6	47.4	37.1	24.5	17.3	12.9	9.99	7.96	6.49
	4.0	8.43	P_{cx}	478	407	327	253	195	152	122	82.4	59.2	44.5	34.6	27.7	22.7
			P_{cy}	373	243	157	108	78.2	59.1	46.1	30.4	21.5	16.0	12.4	9.85	8.03
	5.0	10.2	P_{cx}	576	487	388	297	228	178	142	95.9	68.8	51.7	40.2	32.2	26.3
			P_{cy}	444	285	183	125	90.5	68.3	53.3	35.0	24.8	18.4	14.3	11.3	9.25
	6.0	11.9	P_{cx}	664	558	439	334	255	198	158	106	76.4	57.3	44.6	35.7	29.2
			P_{cy}	504	318	203	138	100	75.5	58.9	38.7	27.3	20.3	15.7	12.5	10.2
150 x 75	* 3.0	10.1	P_{cx}	440	440	416	381	342	302	263	196	148	115	91.4	74.2	61.3
			P_{cy}	435	377	309	244	190	150	120	81.8	58.9	44.3	34.6	27.7	22.7
	* 4.0	13.2	P_{cx}	659	659	606	547	483	418	357	261	195	150	118	96.0	79.2
			P_{cy}	638	539	428	328	251	196	156	105	75.7	56.9	44.3	35.4	29.0
	* 5.0	16.1	P_{cx}	899	885	805	716	621	529	446	321	237	182	143	115	95.4
			P_{cy}	852	703	542	406	307	238	189	126	90.8	68.1	52.9	42.3	34.6
	6.0	19.0	P_{cx}	1100	1080	974	858	737	622	522	372	274	209	165	133	109
			P_{cy}	1030	841	637	472	355	274	217	145	103	77.8	60.5	48.3	39.5
	8.0	24.2	P_{cx}	1410	1370	1230	1070	914	766	639	452	333	253	199	160	132
			P_{cy}	1310	1050	781	573	428	330	261	174	124	93.2	72.4	57.8	47.3
150 x 100	* 3.0	11.3	P_{cx}	475	475	457	422	384	344	303	231	176	137	109	89.2	73.8
			P_{cy}	475	454	406	352	297	246	204	144	105	80.5	63.2	50.9	41.9
	* 4.0	14.8	P_{cx}	751	751	700	636	566	494	426	314	236	182	144	116	96.4
			P_{cy}	751	694	605	507	415	337	275	190	138	105	82.2	66.1	54.2
	* 5.0	18.1	P_{cx}	1010	1010	925	831	729	627	534	388	289	222	175	141	116
			P_{cy}	1010	916	785	645	518	416	338	232	168	127	99.3	79.7	65.4
	6.0	21.3	P_{cx}	1240	1230	1120	998	869	742	628	453	336	257	202	163	135
			P_{cy}	1240	1110	939	763	608	485	392	268	194	146	114	91.9	75.4
	8.0	27.4	P_{cx}	1600	1570	1420	1260	1090	925	780	559	413	316	249	201	165
			P_{cy}	1600	1410	1180	950	752	598	482	329	237	179	139	112	92.0

* Section is slender under axial compression and allowance has been made in calculating the compression resistance.

For explanation of table see Section 8.4.

Table 68

COMPRESSION

**RECTANGULAR HOLLOW SECTIONS
SUBJECT TO AXIAL COMPRESSION**

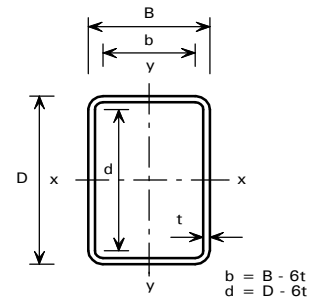

COMPRESSION RESISTANCE FOR GRADE 1.4462 (2205)

D x B mm	t mm	Mass per Metre kg	Axis	Compression Resistance, P_{cx} , P_{cy} (kN)												
				for Effective Length L_E (m)												
				1.0	1.5	2.0	2.5	3.0	3.5	4.0	5.0	6.0	7.0	8.0	9.0	10.0
200 x 100	* 4.0	17.9	P_{cx}	782	782	782	754	709	660	609	502	404	325	264	217	181
			P_{cy}	782	749	670	581	490	408	338	238	175	133	104	84.3	69.3
	* 5.0	22.1	P_{cx}	1070	1070	1070	1010	946	873	796	642	509	405	327	268	223
			P_{cy}	1070	1010	886	754	625	512	421	293	214	162	127	102	84.1
	* 6.0	26.1	P_{cx}	1380	1380	1370	1280	1190	1090	983	778	608	480	385	315	262
			P_{cy}	1380	1270	1110	924	753	610	498	344	250	189	148	119	97.8
	8.0	33.7	P_{cx}	1960	1960	1910	1780	1630	1470	1310	1010	780	611	488	397	329
			P_{cy}	1960	1760	1500	1220	974	779	631	432	312	236	184	148	121
	10.0	40.8	P_{cx}	2380	2380	2300	2140	1950	1750	1550	1190	913	713	568	462	383
			P_{cy}	2380	2110	1780	1440	1140	908	733	500	361	273	213	170	140
200 x 125	* 4.0	19.5	P_{cx}	836	836	836	816	770	721	669	560	457	370	302	250	209
			P_{cy}	836	836	783	714	638	559	484	358	270	208	165	133	110
	* 5.0	24.0	P_{cx}	1190	1190	1190	1130	1060	982	900	733	585	467	378	310	259
			P_{cy}	1190	1180	1080	969	849	730	622	451	335	257	203	164	135
	* 6.0	28.5	P_{cx}	1520	1520	1520	1430	1330	1220	1110	889	700	555	447	366	304
			P_{cy}	1520	1490	1360	1200	1040	885	746	535	395	302	238	192	158
	8.0	36.9	P_{cx}	2150	2150	2120	1980	1820	1660	1490	1170	905	711	570	465	386
			P_{cy}	2150	2070	1860	1630	1380	1160	964	682	501	382	300	242	199
	10.0	44.8	P_{cx}	2610	2610	2560	2380	2190	1990	1770	1380	1070	837	669	546	453
			P_{cy}	2610	2500	2240	1940	1640	1370	1140	800	587	447	351	282	232
250 x 125	* 6.0	33.2	P_{cx}	1580	1580	1580	1580	1520	1440	1360	1190	1000	837	696	582	491
			P_{cy}	1580	1580	1460	1320	1160	1010	865	633	473	364	287	232	192
	* 8.0	43.2	P_{cx}	2360	2360	2360	2330	2210	2080	1940	1650	1360	1120	916	759	637
			P_{cy}	2360	2320	2100	1860	1610	1370	1150	824	609	466	367	296	244
	10.0	52.7	P_{cx}	3070	3070	3070	2990	2820	2640	2450	2050	1670	1350	1100	911	762
			P_{cy}	3070	2970	2670	2340	1990	1670	1390	986	725	553	434	350	288
	12.0	61.7	P_{cx}	3590	3590	3590	3480	3280	3070	2840	2360	1910	1540	1260	1040	865
			P_{cy}	3590	3450	3090	2690	2280	1900	1580	1120	819	624	490	395	324
	15.0	74.1	P_{cx}	4320	4320	4320	4150	3900	3630	3340	2750	2210	1780	1440	1190	989
			P_{cy}	4320	4110	3660	3160	2650	2190	1810	1270	931	708	556	447	368
250 x 150	* 6.0	35.6	P_{cx}	1720	1720	1720	1720	1660	1580	1500	1310	1120	935	780	654	553
			P_{cy}	1720	1720	1670	1550	1420	1280	1130	871	669	523	417	339	281
	* 8.0	46.4	P_{cx}	2550	2550	2550	2530	2410	2270	2130	1820	1520	1250	1030	856	720
			P_{cy}	2550	2550	2420	2220	2000	1770	1540	1150	874	677	537	436	360
	10.0	56.6	P_{cx}	3300	3300	3300	3240	3070	2890	2690	2270	1870	1520	1250	1030	865
			P_{cy}	3300	3300	3080	2800	2500	2190	1890	1400	1050	811	642	520	429
	12.0	66.4	P_{cx}	3870	3870	3870	3790	3580	3360	3120	2620	2150	1740	1430	1180	987
			P_{cy}	3870	3870	3590	3260	2890	2520	2170	1600	1200	922	730	591	488
	15.0	80.1	P_{cx}	4660	4660	4660	4530	4280	4000	3700	3080	2510	2030	1650	1360	1140
			P_{cy}	4660	4660	4290	3870	3410	2960	2530	1850	1380	1060	838	678	559

* Section is slender under axial compression and allowance has been made in calculating the compression resistance.

For explanation of table see Section 8.4.

Table 68

COMPRESSION

**RECTANGULAR HOLLOW SECTIONS
SUBJECT TO AXIAL COMPRESSION**

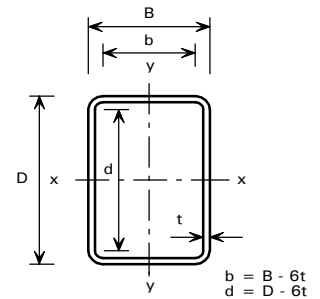

COMPRESSION RESISTANCE FOR GRADE 1.4462 (2205)

D x B mm	t mm	Mass per Metre kg	Axis	Compression Resistance, P_{cx} , P_{cy} (kN)												
				for Effective Length L_E (m)												
				2.0	3.0	4.0	5.0	6.0	7.0	8.0	9.0	10.0	11.0	12.0	13.0	14.0
300 x 150	* 6.0	40.3	P_{cx}	1760	1760	1660	1520	1370	1210	1050	911	787	682	595	522	460
			P_{cy}	1740	1510	1240	977	762	601	482	393	327	275	235	203	177
	* 8.0	52.7	P_{cx}	2640	2640	2430	2190	1930	1670	1430	1220	1050	900	780	682	600
			P_{cy}	2550	2160	1720	1310	1010	785	626	509	422	355	302	261	227
	* 10.0	64.5	P_{cx}	3600	3540	3220	2870	2490	2120	1790	1510	1280	1100	951	828	728
			P_{cy}	3410	2820	2170	1630	1230	953	756	613	507	426	363	312	272
	12.0	75.9	P_{cx}	4420	4310	3900	3440	2950	2490	2090	1760	1490	1270	1100	956	838
			P_{cy}	4140	3360	2550	1890	1420	1100	868	703	581	487	415	357	311
	15.0	91.9	P_{cx}	5350	5190	4670	4090	3490	2930	2450	2060	1740	1480	1280	1110	976
			P_{cy}	4970	4000	2990	2200	1650	1270	1010	814	671	563	479	412	359
300 x 200	* 6.0	45.0	P_{cx}	1900	1900	1830	1690	1540	1380	1220	1060	925	807	707	622	551
			P_{cy}	1900	1820	1630	1410	1190	987	819	684	577	491	423	367	322
	* 8.0	59.0	P_{cx}	3010	3010	2800	2550	2270	1980	1710	1460	1260	1090	944	827	728
			P_{cy}	3010	2780	2420	2030	1660	1350	1100	911	762	646	554	480	420
	* 10.0	72.4	P_{cx}	4060	4040	3700	3320	2920	2510	2140	1820	1550	1340	1160	1010	888
			P_{cy}	4060	3670	3140	2580	2080	1670	1350	1110	928	785	672	582	508
	12.0	85.4	P_{cx}	4970	4910	4480	3990	3480	2970	2510	2130	1810	1550	1340	1170	1030
			P_{cy}	4970	4430	3760	3050	2430	1940	1570	1290	1080	908	777	672	586
	15.0	103	P_{cx}	6040	5940	5400	4800	4150	3530	2980	2520	2140	1830	1580	1380	1210
			P_{cy}	6040	5340	4500	3630	2880	2290	1850	1520	1260	1070	911	787	687
350 x 175	* 6.0	47.4	P_{cx}	1890	1890	1890	1780	1660	1520	1380	1240	1110	984	873	777	693
			P_{cy}	1890	1770	1550	1310	1080	882	724	600	503	427	366	317	278
	* 8.0	62.2	P_{cx}	2890	2890	2830	2630	2420	2190	1960	1730	1520	1330	1170	1040	920
			P_{cy}	2890	2610	2230	1840	1470	1180	960	790	659	557	477	413	360
	* 10.0	76.4	P_{cx}	3960	3960	3800	3510	3190	2850	2510	2190	1910	1660	1450	1280	1130
			P_{cy}	3960	3470	2900	2330	1840	1460	1180	963	802	677	578	500	436
	* 12.0	90.1	P_{cx}	5090	5090	4810	4400	3960	3490	3040	2620	2270	1970	1710	1500	1330
			P_{cy}	5030	4340	3560	2800	2180	1720	1380	1120	932	785	670	579	505
	15.0	109	P_{cx}	6390	6390	5970	5430	4840	4240	3660	3150	2710	2340	2030	1780	1570
			P_{cy}	6250	5340	4320	3350	2590	2030	1620	1320	1100	923	787	679	592
350 x 200	* 6.0	49.8	P_{cx}	1930	1930	1930	1840	1720	1590	1450	1310	1180	1050	935	834	746
			P_{cy}	1930	1880	1700	1500	1280	1080	907	763	646	552	476	414	364
	* 8.0	65.3	P_{cx}	3080	3080	3020	2820	2600	2360	2110	1870	1650	1450	1280	1130	1000
			P_{cy}	3080	2900	2560	2190	1820	1500	1230	1020	860	731	628	545	477
	* 10.0	80.3	P_{cx}	4190	4190	4040	3740	3410	3060	2710	2370	2070	1810	1580	1390	1230
			P_{cy}	4190	3860	3360	2810	2300	1860	1520	1260	1050	892	765	663	579
	* 12.0	94.8	P_{cx}	5370	5370	5110	4690	4230	3750	3280	2850	2470	2140	1870	1640	1450
			P_{cy}	5370	4850	4160	3420	2750	2210	1790	1470	1230	1040	891	771	674
	15.0	115	P_{cx}	6730	6730	6340	5790	5190	4570	3970	3430	2960	2560	2230	1950	1720
			P_{cy}	6730	6000	5090	4140	3300	2630	2130	1750	1460	1230	1050	911	795

* Section is slender under axial compression and allowance has been made in calculating the compression resistance.

For explanation of table see Section 8.4.

Table 68

COMPRESSION

**RECTANGULAR HOLLOW SECTIONS
SUBJECT TO AXIAL COMPRESSION**

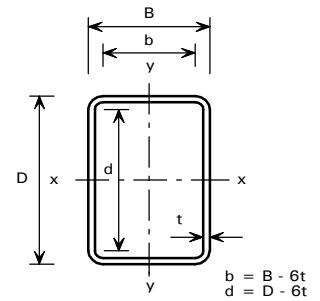

COMPRESSION RESISTANCE FOR GRADE 1.4462 (2205)

D x B mm	t mm	Mass per Metre kg	Axis	Compression Resistance, P_{cx} , P_{cy} (kN)												
				for Effective Length L_E (m)												
				2.0	3.0	4.0	5.0	6.0	7.0	8.0	9.0	10.0	11.0	12.0	13.0	14.0
400 x 200	* 6.0	54.5	P_{cx}	1960	1960	1960	1940	1840	1740	1630	1510	1390	1270	1160	1050	951
			P_{cy}	1960	1930	1760	1570	1370	1170	988	837	712	611	528	460	405
	* 8.0	71.6	P_{cx}	3130	3130	3130	3020	2840	2640	2440	2220	2010	1810	1620	1450	1300
			P_{cy}	3130	3000	2680	2330	1960	1630	1360	1130	955	813	700	608	533
	* 10.0	88.2	P_{cx}	4280	4280	4280	4050	3780	3490	3190	2870	2570	2290	2040	1810	1620
			P_{cy}	4280	4020	3550	3020	2500	2050	1680	1400	1170	997	856	742	650
	* 12.0	104	P_{cx}	5530	5530	5490	5140	4760	4360	3930	3510	3110	2750	2430	2160	1920
			P_{cy}	5530	5090	4420	3700	3010	2440	1990	1650	1380	1170	1000	867	758
	15.0	127	P_{cx}	7420	7420	7250	6740	6190	5590	4980	4400	3860	3380	2980	2630	2330
			P_{cy}	7420	6660	5680	4640	3720	2980	2410	1980	1650	1400	1200	1030	903
400 x 250	* 6.0	59.3	P_{cx}	2020	2020	2020	2020	1940	1840	1730	1620	1510	1390	1270	1160	1060
			P_{cy}	2020	2020	1960	1820	1670	1510	1340	1180	1030	904	794	700	621
	* 8.0	78.0	P_{cx}	3340	3340	3340	3260	3080	2890	2680	2460	2240	2030	1830	1650	1480
			P_{cy}	3340	3340	3130	2860	2550	2240	1940	1670	1440	1240	1080	946	834
	* 10.0	96.1	P_{cx}	4740	4740	4740	4530	4240	3930	3600	3260	2930	2620	2340	2090	1870
			P_{cy}	4740	4720	4320	3880	3400	2920	2490	2120	1810	1550	1340	1170	1030
	* 12.0	113	P_{cx}	6080	6080	6080	5710	5320	4890	4440	3990	3560	3160	2800	2490	2220
			P_{cy}	6080	5970	5430	4820	4170	3540	2980	2520	2140	1830	1580	1380	1210
	15.0	139	P_{cx}	8110	8110	8000	7470	6900	6280	5640	5010	4430	3900	3440	3050	2710
			P_{cy}	8110	7840	7050	6170	5250	4400	3670	3080	2600	2220	1910	1660	1460

* Section is slender under axial compression and allowance has been made in calculating the compression resistance.

For explanation of table see Section 8.4.

Table 69

COMPRESSION

**SQUARE HOLLOW SECTIONS
SUBJECT TO AXIAL COMPRESSION**

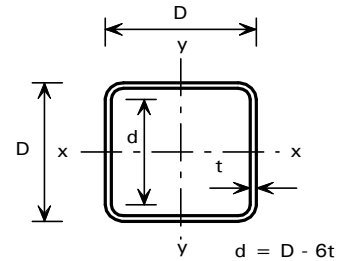

COMPRESSION RESISTANCE FOR GRADE 1.4462 (2205)

D x D mm	t mm	Mass per Metre kg	Compression Resistance P_c (kN)												
			for Effective Length L_e (m)												
			1.0	1.5	2.0	2.5	3.0	3.5	4.0	5.0	6.0	7.0	8.0	9.0	10.0
40 x 40	2.0	2.27	77.0	43.1	26.4	17.7	12.6	9.47	7.36	4.81	3.39	2.51	1.94	1.54	1.26
	3.0	3.20	103	57.1	34.8	23.2	16.6	12.4	9.64	6.30	4.43	3.29	2.54	2.02	1.64
50 x 50	2.0	2.90	124	79.3	50.8	34.7	25.0	18.9	14.7	9.68	6.84	5.09	3.94	3.13	2.55
	3.0	4.15	174	108	69.2	47.1	33.9	25.5	19.9	13.1	9.25	6.88	5.32	4.23	3.45
	4.0	5.27	214	131	83.1	56.4	40.6	30.5	23.8	15.6	11.0	8.20	6.33	5.04	4.11
60 x 60	* 2.0	3.53	164	120	82.6	58.1	42.6	32.4	25.5	16.9	12.0	8.93	6.92	5.52	4.50
	3.0	5.10	245	173	116	81.4	59.4	45.1	35.3	23.3	16.6	12.3	9.56	7.62	6.22
	4.0	6.54	310	215	143	99.9	72.7	55.1	43.2	28.5	20.2	15.1	11.7	9.29	7.58
	5.0	7.84	365	249	165	114	83.0	62.8	49.2	32.4	23.0	17.1	13.2	10.6	8.61
80 x 80	* 2.0	4.79	208	180	147	116	90.7	71.4	57.3	38.8	27.9	21.0	16.4	13.1	10.8
	3.0	6.99	384	316	242	181	137	106	84.2	56.4	40.4	30.3	23.5	18.8	15.4
	4.0	9.06	495	404	308	228	172	133	105	70.7	50.5	37.9	29.4	23.5	19.2
	5.0	11.0	597	484	365	269	202	156	123	82.8	59.2	44.3	34.4	27.5	22.5
100 x 100	* 3.0	8.89	449	409	353	292	236	191	155	107	77.7	58.8	45.9	36.9	30.3
	4.0	11.6	674	594	498	401	317	252	203	138	100	75.5	58.9	47.2	38.7
	5.0	14.2	824	720	601	481	379	300	242	165	119	89.7	70.0	56.1	46.0
	6.0	16.6	962	838	696	554	434	344	276	188	135	102	79.7	63.9	52.3
	8.0	21.1	1210	1050	859	676	526	414	332	225	162	122	95.2	76.3	62.5
125 x 125	* 3.0	11.3	479	479	442	399	353	306	262	192	143	110	87.4	70.7	58.3
	* 4.0	14.8	782	760	686	603	517	435	364	259	190	145	114	92.5	76.1
	5.0	18.1	1050	1010	899	778	655	544	451	317	232	177	139	111	92.0
	6.0	21.3	1240	1180	1050	909	762	631	522	366	268	204	160	129	106
	8.0	27.4	1600	1510	1340	1140	952	784	646	451	330	250	196	158	130
150 x 150	* 3.0	13.6	500	500	498	467	434	398	360	287	225	178	143	117	97.7
	* 4.0	17.9	828	828	798	738	672	601	531	405	309	241	192	156	129
	* 5.0	22.1	1200	1200	1130	1030	918	805	696	516	388	300	237	192	159
	6.0	26.1	1520	1520	1400	1270	1120	973	834	611	457	351	278	225	185
	8.0	33.7	1960	1960	1800	1620	1430	1230	1050	766	572	439	347	280	231

* Section is slender under axial compression and allowance has been made in calculating the compression resistance.

For explanation of table see Section 8.4.

Table 69

COMPRESSION

**SQUARE HOLLOW SECTIONS
SUBJECT TO AXIAL COMPRESSION**

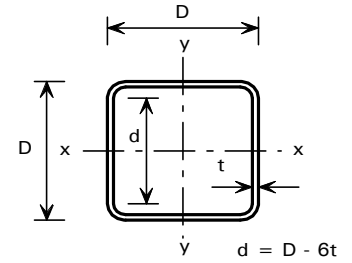

COMPRESSION RESISTANCE FOR GRADE 1.4462 (2205)

D x D mm	t mm	Mass per Metre kg	Compression Resistance P_c (kN)												
			for Effective Length L_e (m)												
			2.0	3.0	4.0	5.0	6.0	7.0	8.0	9.0	10.0	11.0	12.0	13.0	14.0
175 x 175	* 4.0	21.1	862	781	670	551	444	356	289	238	199	168	144	124	109
	* 5.0	26.0	1260	1100	915	728	572	452	364	297	247	209	178	154	134
	* 6.0	30.8	1680	1440	1160	898	693	543	434	354	293	247	210	181	158
	8.0	40.0	2260	1910	1510	1160	887	692	551	449	371	312	266	229	200
	10.0	48.7	2730	2300	1810	1380	1050	818	651	529	438	368	314	271	236
200 x 200	* 4.0	24.2	889	859	772	675	574	481	401	336	284	242	208	181	159
	* 5.0	30.0	1320	1240	1090	923	764	625	514	426	357	303	260	226	198
	* 6.0	35.6	1800	1640	1410	1170	947	764	621	512	428	362	310	268	235
	8.0	46.4	2700	2380	1990	1600	1270	1010	812	666	554	468	400	345	301
	10.0	56.6	3300	2880	2410	1930	1520	1200	968	793	660	557	476	411	358
250 x 250	* 5.0	37.9	1390	1390	1320	1210	1090	960	837	724	626	543	474	416	367
	* 6.0	45.0	1920	1920	1770	1600	1410	1230	1050	897	768	662	574	502	442
	* 8.0	59.0	3130	3040	2750	2420	2070	1740	1460	1220	1040	885	763	664	583
	10.0	72.4	4220	4030	3600	3120	2620	2180	1810	1510	1270	1080	930	808	708
	12.0	85.4	4970	4730	4210	3640	3050	2530	2090	1740	1470	1250	1070	932	817
300 x 300	* 5.0	45.8	1440	1440	1440	1380	1300	1210	1110	1010	907	813	727	650	583
	* 6.0	54.5	2000	2000	1990	1870	1740	1590	1440	1290	1150	1020	902	801	714
	* 8.0	71.6	3310	3310	3190	2950	2690	2410	2130	1860	1620	1410	1240	1090	965
	* 10.0	88.2	4820	4820	4510	4110	3680	3220	2790	2400	2070	1790	1550	1360	1200
	12.0	104	6070	6070	5610	5070	4490	3890	3340	2850	2450	2110	1830	1600	1410
350 x 350	* 6.0	64.0	2060	2060	2060	2060	1960	1850	1730	1610	1490	1360	1240	1130	1020
	* 8.0	84.3	3450	3450	3450	3330	3130	2910	2680	2440	2210	1980	1780	1590	1430
	* 10.0	104	5070	5070	5050	4740	4410	4040	3660	3280	2910	2580	2290	2030	1810
	* 12.0	123	6870	6870	6720	6250	5740	5190	4630	4090	3590	3150	2770	2450	2170
	15.0	151	8800	8800	8520	7900	7210	6480	5740	5030	4400	3850	3370	2970	2630
400 x 400	* 6.0	73.5	2110	2110	2110	2110	2110	2030	1940	1840	1750	1640	1540	1430	1330
	* 8.0	96.9	3560	3560	3560	3560	3440	3270	3090	2900	2700	2500	2300	2110	1920
	* 10.0	119	5270	5270	5270	5210	4940	4650	4350	4030	3700	3370	3060	2770	2500
	* 12.0	142	7190	7190	7190	6970	6560	6120	5660	5170	4690	4220	3790	3400	3060
	15.0	174	10200	10200	10200	9620	8980	8280	7540	6800	6070	5410	4810	4280	3820

* Section is slender under axial compression and allowance has been made in calculating the compression resistance.

For explanation of table see Section 8.4.

Table 70

COMPRESSION

CHANNELS
SUBJECT TO AXIAL COMPRESSION

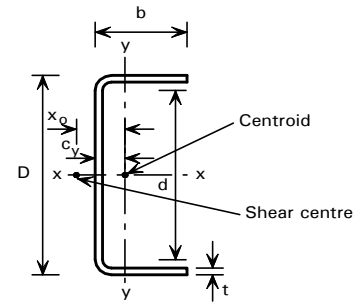

COMPRESSION RESISTANCE FOR GRADE 1.4462 (2205)

D x b mm	t mm	Mass per Metre kg	Axis	Compression Resistance, P _{cx} , P _{oxz} , P _{cy} (kN)													
				for Effective Length L _E (m)													
				1.0	1.5	2.0	2.5	3.0	3.5	4.0	5.0	6.0	7.0	8.0	9.0	10.0	
50 x 25	* 2.0	1.45	P _{cx}	57.5	38.1	24.8	17.1	12.4	9.34	7.30	4.81	3.40	2.53	1.96	1.56	1.27	
			P _{oxz}	26.3	20.6	16.6	13.2	10.4	8.33	6.73	4.61	3.32	2.50	1.95	1.56	1.27	
			P _{cy}	17.3	8.36	4.89	3.20	2.26	1.68	1.29	0.838	0.587	0.434	0.333	0.264	0.215	
	3.0	2.08	P _{cx}	87.0	54.4	34.6	23.5	17.0	12.8	9.96	6.54	4.62	3.44	2.66	2.12	1.72	
			P _{oxz}	56.7	42.2	30.2	21.8	16.3	12.5	9.84	6.54	4.64	3.46	2.68	2.13	1.74	
			P _{cy}	24.4	11.7	6.80	4.45	3.13	2.32	1.79	1.16	0.812	0.600	0.461	0.366	0.297	
75 x 35	* 3.0	3.14	P _{cx}	154	125	95.4	70.7	53.2	41.1	32.5	21.8	15.6	11.7	9.06	7.24	5.92	
			P _{oxz}	76.0	59.5	50.7	43.8	37.7	32.1	27.2	19.7	14.6	11.2	8.85	7.13	5.87	
			P _{cy}	64.7	32.8	19.5	12.9	9.15	6.82	5.28	3.43	2.41	1.79	1.37	1.09	0.887	
	* 4.0	4.06	P _{cx}	213	168	124	90.5	67.4	51.8	40.9	27.3	19.4	14.6	11.3	9.02	7.37	
			P _{oxz}	125	104	87.3	71.6	57.8	46.8	38.2	26.4	19.1	14.5	11.3	9.05	7.41	
			P _{cy}	83.5	41.9	24.8	16.4	11.6	8.63	6.68	4.34	3.04	2.25	1.73	1.38	1.12	
	5.0	4.91	P _{cx}	258	201	146	106	78.8	60.4	47.6	31.7	22.6	16.9	13.1	10.5	8.55	
			P _{oxz}	178	150	121	94.6	73.6	58.0	46.5	31.6	22.7	17.0	13.2	10.6	8.66	
			P _{cy}	99.1	49.5	29.3	19.3	13.7	10.2	7.88	5.12	3.59	2.66	2.04	1.62	1.32	
	100 x 50	* 3.0	4.45	P _{cx}	191	179	158	134	111	91.4	75.1	52.3	38.2	29.0	22.7	18.3	15.0
				P _{oxz}	111	77.3	60.4	51.1	45.3	41.0	37.6	31.8	26.8	22.5	18.9	15.9	13.5
				P _{cy}	135	83.2	52.6	35.7	25.7	19.4	15.1	9.90	6.99	5.20	4.02	3.20	2.60
* 4.0		5.80	P _{cx}	296	268	230	189	152	122	99.3	68.2	49.4	37.4	29.2	23.4	19.2	
			P _{oxz}	169	126	105	92.1	82.4	74.0	66.3	52.7	41.8	33.3	26.9	22.1	18.4	
			P _{cy}	191	111	69.3	46.7	33.4	25.1	19.5	12.8	9.03	6.70	5.18	4.12	3.35	
* 5.0		7.08	P _{cx}	389	344	290	235	186	148	119	81.9	59.2	44.7	34.9	28.0	22.9	
			P _{oxz}	232	187	161	142	125	109	95.2	71.5	54.4	42.3	33.7	27.3	22.6	
			P _{cy}	238	136	84.1	56.4	40.4	30.3	23.6	15.4	10.9	8.07	6.23	4.95	4.03	
125 x 50		* 3.0	5.04	P _{cx}	199	199	184	166	147	127	109	80.5	60.2	46.3	36.6	29.6	24.5
				P _{oxz}	131	92.3	70.5	58.5	51.3	46.5	43.1	38.1	34.1	30.5	26.9	23.6	20.6
				P _{cy}	142	88.6	56.3	38.3	27.6	20.8	16.2	10.6	7.51	5.58	4.32	3.43	2.80
	* 4.0	6.59	P _{cx}	323	315	284	250	215	181	151	108	79.7	60.9	47.9	38.6	31.8	
			P _{oxz}	201	147	120	105	95.2	88.0	81.9	70.8	60.2	50.4	42.1	35.2	29.7	
			P _{cy}	207	120	74.9	50.4	36.1	27.1	21.1	13.8	9.74	7.24	5.59	4.44	3.62	
	* 5.0	8.07	P _{cx}	446	426	379	327	275	227	188	132	97.0	73.8	57.9	46.6	38.3	
			P _{oxz}	277	217	186	167	153	141	129	105	84.3	67.5	54.7	44.9	37.4	
			P _{cy}	265	149	91.7	61.5	43.9	33.0	25.6	16.7	11.8	8.76	6.76	5.37	4.37	
	6.0	9.49	P _{cx}	552	520	459	392	325	267	220	153	112	85.1	66.7	53.7	44.1	
			P _{oxz}	358	298	265	242	220	198	175	135	104	81.7	65.1	53.0	43.8	
			P _{cy}	315	174	106	71.4	51.0	38.2	29.7	19.4	13.7	10.1	7.82	6.22	5.06	
150 x 60	* 4.0	8.01	P _{cx}	343	343	331	306	279	250	221	169	129	100	80.5	65.4	54.2	
			P _{oxz}	249	184	142	118	103	93.9	86.8	76.9	69.4	62.7	56.2	49.9	44.1	
			P _{cy}	272	184	121	84.1	61.1	46.2	36.2	23.8	16.9	12.6	9.73	7.75	6.32	
	* 5.0	9.85	P _{cx}	498	498	467	426	381	334	289	215	161	125	99.2	80.4	66.4	
			P _{oxz}	347	261	211	182	164	152	142	125	110	95.7	82.0	70.1	60.0	
			P _{cy}	371	237	152	104	75.4	56.9	44.4	29.2	20.6	15.4	11.9	9.45	7.70	
	* 6.0	11.6	P _{cx}	643	643	592	534	471	408	349	255	190	146	115	93.8	77.4	
			P _{oxz}	444	349	295	263	241	224	209	180	151	126	104	87.3	73.6	
			P _{cy}	459	285	180	122	88.5	66.7	52.0	34.1	24.1	17.9	13.9	11.0	8.99	
	8.0	15.0	P _{cx}	871	862	787	703	613	525	445	321	238	182	144	116	96.0	
			P _{oxz}	630	544	492	455	421	386	350	279	219	174	140	114	95.3	
			P _{cy}	600	364	229	155	111	83.9	65.4	42.9	30.3	22.5	17.4	13.8	11.3	

See Section 8.4.2 for guidance on calculating an effective length which allows for both the effects of end fixity and nominal end moments due to eccentricity of connection.

Slender sections must also be checked for the combined effects of the axial load and moment caused by the shift of neutral axis, see Section 8.4.2.

* Section is slender under axial compression and allowance has been made in calculating the compression resistance.

For explanation of table see Section 8.4

Table 70

COMPRESSION

**CHANNELS
SUBJECT TO AXIAL COMPRESSION**

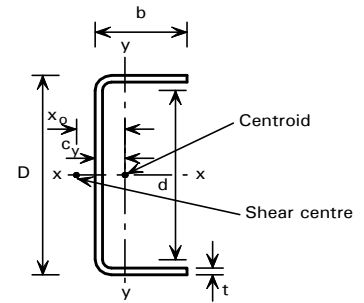

COMPRESSION RESISTANCE FOR GRADE 1.4462 (2205)

D x b mm	t mm	Mass per Metre kg	Axis	Compression Resistance, P_{cx} , P_{czz} , P_{cy} (kN)												
				for Effective Length L_E (m)												
				1.0	1.5	2.0	2.5	3.0	3.5	4.0	5.0	6.0	7.0	8.0	9.0	10.0
175 x 60	* 5.0	10.8	P_{cx}	514	514	507	473	437	398	357	280	218	171	137	112	93.2
			P_{czz}	376	285	227	194	173	159	149	135	123	113	101	90.6	79.9
			P_{cy}	385	248	159	109	79.0	59.6	46.5	30.6	21.6	16.1	12.5	9.91	8.08
	* 6.0	12.8	P_{cx}	693	693	669	619	565	506	447	342	262	204	162	132	109
			P_{czz}	493	382	317	279	255	239	226	204	183	160	138	118	101
			P_{cy}	489	301	190	129	93.3	70.2	54.8	35.9	25.4	18.9	14.6	11.6	9.45
	8.0	16.5	P_{cx}	963	963	915	839	757	670	585	439	332	258	204	166	137
			P_{czz}	701	592	530	491	462	436	410	352	292	238	195	161	135
			P_{cy}	649	388	243	164	118	88.9	69.2	45.4	32.0	23.8	18.4	14.6	11.9
	10.0	20.0	P_{cx}	1170	1170	1100	1010	902	795	691	515	389	301	238	193	159
			P_{czz}	896	812	762	723	683	637	584	471	372	295	237	194	161
			P_{cy}	775	460	287	194	139	104	81.7	53.5	37.8	28.1	21.7	17.2	14.0
200 x 75	* 5.0	13.0	P_{cx}	542	542	542	534	506	475	443	375	309	252	206	171	143
			P_{czz}	445	359	284	232	198	175	159	138	125	116	108	101	93.8
			P_{cy}	486	375	269	193	143	109	86.6	57.6	41.0	30.7	23.8	19.0	15.5
	* 6.0	15.4	P_{cx}	738	738	738	711	668	623	574	473	381	306	249	205	171
			P_{czz}	589	471	378	317	278	252	233	208	190	175	160	146	132
			P_{cy}	639	474	330	233	171	130	102	68.2	48.5	36.2	28.0	22.4	18.3
	* 8.0	20.0	P_{cx}	1130	1130	1130	1060	981	900	815	649	509	403	324	265	220
			P_{czz}	877	716	605	536	491	458	432	390	349	308	268	232	200
			P_{cy}	932	654	440	306	223	169	132	87.7	62.2	46.4	35.9	28.6	23.3
	10.0	24.4	P_{cx}	1420	1420	1400	1310	1210	1110	994	782	609	480	385	314	261
			P_{czz}	1120	960	861	795	748	708	670	590	505	425	355	298	252
			P_{cy}	1150	795	529	367	267	202	158	104	74.2	55.3	42.8	34.1	27.8
225 x 75	* 6.0	16.6	P_{cx}	754	754	754	752	716	677	636	547	457	378	312	260	218
			P_{czz}	618	502	403	336	291	261	240	213	196	184	172	162	151
			P_{cy}	655	488	341	241	177	135	106	70.6	50.2	37.5	29.0	23.2	18.9
	* 8.0	21.6	P_{cx}	1210	1210	1210	1170	1100	1030	948	785	634	511	415	342	286
			P_{czz}	952	774	646	565	512	476	450	412	380	349	316	282	249
			P_{cy}	988	687	460	319	232	176	138	91.3	64.7	48.2	37.3	29.8	24.3
	10.0	26.3	P_{cx}	1530	1530	1530	1470	1380	1280	1170	959	767	614	497	409	341
			P_{czz}	1220	1040	914	838	786	747	714	654	587	515	443	379	324
			P_{cy}	1230	840	556	384	279	211	165	109	77.4	57.7	44.6	35.6	29.0
	12.0	30.8	P_{cx}	1800	1800	1800	1710	1600	1480	1360	1100	877	700	566	465	387
			P_{czz}	1450	1300	1200	1130	1080	1040	995	891	768	646	540	452	382
			P_{cy}	1430	969	639	441	320	242	190	125	88.7	66.1	51.1	40.8	33.2
250 x 100	* 6.0	20.2	P_{cx}	796	796	796	796	796	768	736	665	589	511	439	375	321
			P_{czz}	710	623	526	438	369	318	282	234	205	186	172	161	152
			P_{cy}	792	688	570	452	354	280	225	153	110	83.0	64.8	51.9	42.5
	* 8.0	26.3	P_{cx}	1300	1300	1300	1300	1260	1200	1140	1000	860	724	607	510	432
			P_{czz}	1120	962	805	680	590	526	480	420	380	351	327	304	283
			P_{cy}	1250	1050	829	631	482	376	299	201	144	108	84.4	67.6	55.3
	* 10.0	32.3	P_{cx}	1790	1790	1790	1790	1700	1610	1520	1310	1100	911	754	629	530
			P_{czz}	1520	1300	1110	969	869	798	746	671	615	565	516	468	421
			P_{cy}	1690	1390	1060	791	597	462	366	245	175	131	102	81.9	67.0
	12.0	37.9	P_{cx}	2210	2210	2210	2190	2080	1960	1840	1570	1300	1070	880	731	614
			P_{czz}	1870	1630	1430	1290	1190	1120	1060	968	880	792	703	619	542
			P_{cy}	2060	1670	1260	931	699	539	427	285	204	152	118	94.9	77.6

See Section 8.4.2 for guidance on calculating an effective length which allows for both the effects of end fixity and nominal end moments due to eccentricity of connection.

Slender sections must also be checked for the combined effects of the axial load and moment caused by the shift of neutral axis, see Section 8.4.2.

* Section is slender under axial compression and allowance has been made in calculating the compression resistance.

For explanation of table see Section 8.4

Table 70

COMPRESSION

**CHANNELS
SUBJECT TO AXIAL COMPRESSION**

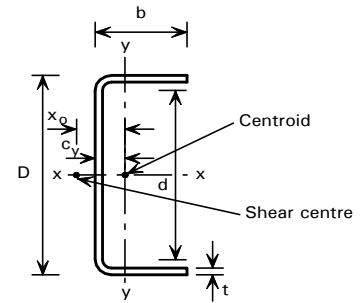

COMPRESSION RESISTANCE FOR GRADE 1.4462 (2205)

D x b mm	t mm	Mass per Metre kg	Axis	Compression Resistance, P_{cx} , P_{czz} , P_{cy} (kN)												
				for Effective Length L_E (m)												
				1.0	1.5	2.0	2.5	3.0	3.5	4.0	5.0	6.0	7.0	8.0	9.0	10.0
300 x 100	* 8.0	29.5	P_{cx}	1340	1340	1340	1340	1340	1320	1270	1170	1050	932	813	705	610
			P_{czz}	1190	1050	893	756	651	574	518	445	401	371	349	332	317
			P_{cy}	1300	1090	868	663	508	396	315	212	152	114	89.2	71.4	58.4
	* 10.0	36.2	P_{cx}	1940	1940	1940	1940	1940	1860	1780	1610	1420	1230	1050	898	768
			P_{czz}	1690	1460	1250	1080	952	863	799	714	660	620	586	553	520
			P_{cy}	1820	1490	1140	844	636	492	390	261	186	139	108	87.0	71.1
	12.0	42.7	P_{cx}	2490	2490	2490	2490	2450	2350	2240	2000	1740	1480	1260	1060	906
			P_{czz}	2140	1860	1620	1440	1310	1220	1150	1050	986	925	864	798	729
			P_{cy}	2300	1840	1370	1000	751	578	457	305	217	163	126	101	82.7
	15.0	51.9	P_{cx}	3020	3020	3020	3020	2970	2840	2700	2400	2080	1770	1490	1260	1070
			P_{czz}	2610	2340	2130	1980	1870	1790	1730	1620	1510	1390	1250	1110	982
			P_{cy}	2780	2210	1640	1200	894	688	543	362	258	193	150	120	98.2
350 x 125	* 8.0	35.8	P_{cx}	1420	1420	1420	1420	1420	1420	1420	1350	1270	1170	1080	974	876
			P_{czz}	1330	1220	1100	966	840	733	647	526	450	401	366	342	322
			P_{cy}	1420	1330	1170	997	825	677	556	387	282	214	168	135	111
	* 10.0	44.1	P_{cx}	2070	2070	2070	2070	2070	2070	2050	1910	1770	1620	1450	1300	1150
			P_{czz}	1910	1730	1540	1350	1180	1040	933	789	699	640	598	565	538
			P_{cy}	2070	1880	1620	1330	1080	865	703	484	350	265	207	166	136
	* 12.0	52.2	P_{cx}	2790	2790	2790	2790	2790	2790	2710	2510	2290	2060	1830	1600	1400
			P_{czz}	2540	2290	2020	1770	1570	1410	1290	1130	1030	955	901	854	811
			P_{cy}	2790	2460	2060	1660	1310	1050	842	575	415	313	244	195	160
	15.0	63.7	P_{cx}	3710	3710	3710	3710	3710	3670	3540	3250	2940	2610	2290	1990	1720
			P_{czz}	3340	3010	2690	2420	2200	2040	1920	1750	1630	1540	1450	1360	1270
			P_{cy}	3680	3190	2630	2080	1620	1280	1030	696	501	377	294	236	193
400 x 150	* 8.0	42.1	P_{cx}	1470	1470	1470	1470	1470	1470	1470	1470	1420	1350	1270	1190	1100
			P_{czz}	1420	1340	1250	1140	1030	919	817	653	541	465	412	374	345
			P_{cy}	1470	1470	1370	1240	1100	960	827	608	456	351	278	225	185
	* 10.0	52.0	P_{cx}	2170	2170	2170	2170	2170	2170	2170	2140	2020	1900	1770	1640	1500
			P_{czz}	2070	1930	1780	1610	1440	1280	1140	930	793	701	637	590	555
			P_{cy}	2170	2140	1940	1730	1500	1280	1080	775	574	439	346	279	230
	* 12.0	61.6	P_{cx}	2950	2950	2950	2950	2950	2950	2950	2850	2680	2490	2300	2090	1890
			P_{czz}	2790	2580	2360	2120	1890	1680	1510	1270	1110	1010	933	877	832
			P_{cy}	2950	2850	2560	2230	1900	1590	1320	935	687	523	411	331	272
	* 15.0	75.6	P_{cx}	4200	4200	4200	4200	4200	4200	4190	3940	3660	3370	3060	2740	2440
			P_{czz}	3910	3590	3260	2920	2630	2380	2190	1910	1730	1610	1510	1430	1370
			P_{cy}	4200	3950	3480	2970	2460	2020	1660	1160	845	641	503	404	332

See Section 8.4.2 for guidance on calculating an effective length which allows for both the effects of end fixity and nominal end moments due to eccentricity of connection.

Slender sections must also be checked for the combined effects of the axial load and moment caused by the shift of neutral axis, see Section 8.4.2.

* Section is slender under axial compression and allowance has been made in calculating the compression resistance.

For explanation of table see Section 8.4

Table 71

COMPRESSION

**DOUBLE CHANNELS BACK TO BACK
SUBJECT TO AXIAL COMPRESSION**

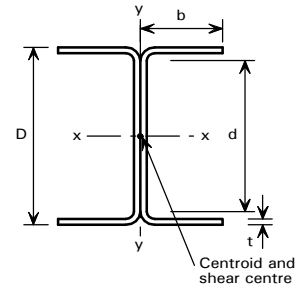

COMPRESSION RESISTANCE FOR GRADE 1.4462 (2205)

D x 2b mm	t mm	Mass per Metre kg	Axis	Compression Resistance, P_{cx} , P_{cy} , P_{cz} (kN)													
				for Effective Length L_E (m)													
				1.0	1.5	2.0	2.5	3.0	3.5	4.0	5.0	6.0	7.0	8.0	9.0	10.0	
50 x 50	* 2.0	2.90	P_{cx}	90.7	61.1	41.6	29.6	22.0	16.9	13.4	8.96	6.41	4.82	3.75	3.00	2.45	
			P_{cy}	48.0	26.0	16.0	10.8	7.72	5.81	4.53	2.97	2.10	1.56	1.21	0.962	0.783	
			P_{cz}	87.7	73.0	66.6	63.4	61.6	60.4	59.7	58.8	58.3	58.1	57.9	57.7	57.6	
	* 3.0	4.15	P_{cx}	136	88.2	58.8	41.3	30.4	23.3	18.4	12.3	8.76	6.57	5.10	4.08	3.34	
			P_{cy}	74.2	39.8	24.3	16.4	11.7	8.83	6.88	4.51	3.19	2.37	1.83	1.46	1.19	
			P_{cz}	167	157	153	151	149	149	148	148	147	147	147	147	147	
75 x 70	* 3.0	6.28	P_{cx}	253	198	151	115	89.5	70.8	57.2	39.3	28.5	21.7	17.0	13.7	11.2	
			P_{cy}	155	93.2	59.7	41.1	29.9	22.7	17.8	11.8	8.40	6.27	4.86	3.88	3.17	
			P_{cz}	230	189	166	154	147	143	140	136	134	133	132	132	131	
	* 4.0	8.12	P_{cx}	345	264	198	149	114	90.1	72.4	49.5	35.9	27.1	21.3	17.1	14.0	
			P_{cy}	213	126	80.8	55.6	40.4	30.6	24.0	15.9	11.3	8.44	6.54	5.22	4.26	
			P_{cz}	338	303	286	277	271	268	266	263	261	261	260	260	259	
	5.0	9.82	P_{cx}	423	320	236	176	135	105	84.9	57.9	41.9	31.6	24.8	19.9	16.3	
			P_{cy}	268	159	101	69.9	50.9	38.6	30.3	20.0	14.2	10.6	8.24	6.57	5.37	
			P_{cz}	449	425	414	409	406	404	402	401	400	400	399	399	399	
100 x 100	* 3.0	8.89	P_{cx}	340	295	252	212	177	147	124	89.6	67.0	51.8	41.2	33.5	27.7	
			P_{cy}	264	191	137	100	75.6	58.7	46.8	31.7	22.8	17.2	13.4	10.8	8.83	
			P_{cz}	317	266	220	188	166	152	141	129	122	117	114	112	111	
	* 4.0	11.6	P_{cx}	511	434	362	298	244	200	166	118	87.9	67.6	53.5	43.3	35.8	
			P_{cy}	389	274	192	138	103	80.3	63.8	43.0	30.9	23.2	18.1	14.5	11.9	
			P_{cz}	478	405	350	315	292	276	266	253	246	241	238	236	235	
	* 5.0	14.2	P_{cx}	657	553	456	370	300	245	202	143	105	81.1	64.1	51.9	42.9	
			P_{cy}	502	350	244	175	131	101	80.5	54.2	38.9	29.3	22.8	18.3	15.0	
			P_{cz}	624	549	499	468	448	435	426	415	409	406	403	401	400	
125 x 100	* 3.0	10.1	P_{cx}	375	337	300	265	232	202	175	132	102	80.4	64.7	53.1	44.3	
			P_{cy}	271	195	138	101	76.2	59.1	47.1	31.8	22.9	17.3	13.5	10.8	8.86	
			P_{cz}	335	282	232	193	167	149	136	121	112	106	102	100	98.5	
	* 4.0	13.2	P_{cx}	592	523	458	395	338	288	245	181	137	107	85.8	70.1	58.2	
			P_{cy}	413	285	197	141	105	81.5	64.6	43.4	31.2	23.4	18.2	14.6	12.0	
			P_{cz}	525	438	367	320	289	268	254	236	226	220	216	213	211	
	* 5.0	16.1	P_{cx}	801	700	604	514	434	365	308	224	169	131	104	85.1	70.6	
			P_{cy}	550	372	254	181	134	103	82.1	55.0	39.4	29.6	23.0	18.4	15.1	
			P_{cz}	712	606	530	481	450	430	416	399	389	383	380	377	375	
	* 6.0	19.0	P_{cx}	979	851	728	615	515	430	362	262	196	152	120	98.3	81.5	
			P_{cy}	673	453	309	219	163	125	99.3	66.5	47.6	35.8	27.8	22.3	18.2	
			P_{cz}	882	776	708	666	640	623	611	597	589	584	580	578	576	
150 x 120	* 4.0	16.0	P_{cx}	664	606	550	496	444	394	349	272	214	171	139	115	96.7	
			P_{cy}	507	386	287	215	165	129	104	71.0	51.4	38.9	30.4	24.5	20.1	
			P_{cz}	599	524	447	382	333	298	272	240	221	209	202	196	192	
	* 5.0	19.7	P_{cx}	944	853	766	681	601	526	460	351	272	215	174	143	119	
			P_{cy}	707	524	381	281	213	166	133	90.6	65.4	49.4	38.6	31.0	25.4	
			P_{cz}	849	736	633	553	497	458	430	395	375	362	354	348	344	
	* 6.0	23.2	P_{cx}	1200	1080	962	848	741	643	557	420	323	254	205	168	140	
			P_{cy}	894	653	470	345	261	203	162	109	79.2	59.8	46.7	37.5	30.7	
			P_{cz}	1080	944	831	749	693	655	628	594	575	563	555	549	545	
	8.0	29.9	P_{cx}	1640	1460	1290	1120	972	836	718	536	409	320	257	210	175	
			P_{cy}	1220	890	639	468	353	274	219	148	106	80.6	63.0	50.5	41.4	
			P_{cz}	1490	1350	1250	1190	1150	1120	1100	1080	1060	1060	1050	1050	1040	

* Section is slender under axial compression and allowance has been made in calculating the compression resistance.

For explanation of table see Section 8.4.

Table 71

COMPRESSION

DOUBLE CHANNELS BACK TO BACK
SUBJECT TO AXIAL COMPRESSION

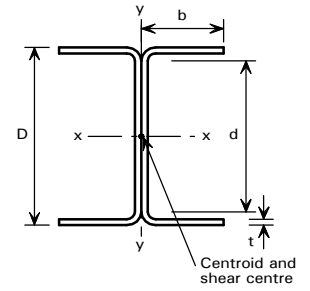

COMPRESSION RESISTANCE FOR GRADE 1.4462 (2205)

D x 2b mm	t mm	Mass per Metre kg	Axis	Compression Resistance, P_{cx} , P_{cy} , P_{cz} (kN)												
				for Effective Length L_E (m)												
				1.0	1.5	2.0	2.5	3.0	3.5	4.0	5.0	6.0	7.0	8.0	9.0	10.0
175 x 120	* 5.0	21.7	P_{cx}	1010	924	847	771	698	628	562	447	356	287	235	195	164
			P_{cy}	724	533	386	284	215	167	134	91.0	65.6	49.5	38.7	31.1	25.5
			P_{cz}	882	765	651	561	495	449	417	375	352	337	327	320	315
	* 6.0	25.6	P_{cx}	1340	1220	1110	1000	895	796	705	551	433	346	282	233	195
			P_{cy}	943	679	483	352	265	206	164	111	79.9	60.2	47.0	37.7	30.9
			P_{cz}	1170	1010	868	765	695	646	612	569	545	530	520	513	508
	8.0	33.1	P_{cx}	1860	1690	1520	1360	1210	1060	932	717	559	443	359	295	247
			P_{cy}	1310	936	662	481	361	280	223	150	108	81.5	63.6	51.0	41.8
			P_{cz}	1630	1450	1320	1230	1170	1130	1100	1070	1050	1030	1030	1020	1020
	10.0	40.1	P_{cx}	2250	2030	1830	1630	1440	1260	1100	844	655	519	419	345	288
			P_{cy}	1610	1160	827	603	454	352	281	190	136	103	80.4	64.5	52.9
			P_{cz}	2000	1850	1760	1700	1660	1640	1620	1600	1590	1580	1580	1570	1570
200 x 150	* 5.0	26.0	P_{cx}	1070	1030	959	893	829	766	705	590	491	409	342	289	246
			P_{cy}	882	719	572	451	357	287	234	162	119	91.0	71.6	57.8	47.6
			P_{cz}	991	904	807	710	623	552	497	423	378	349	329	316	306
	* 6.0	30.8	P_{cx}	1460	1370	1270	1180	1090	994	906	746	611	503	417	350	297
			P_{cy}	1170	937	733	569	446	355	288	199	145	110	87.1	70.2	57.8
			P_{cz}	1330	1200	1070	939	834	753	691	610	560	529	508	494	483
	* 8.0	40.0	P_{cx}	2220	2050	1890	1730	1570	1420	1280	1030	827	671	551	459	387
			P_{cy}	1740	1370	1050	800	621	491	397	273	198	150	118	95.2	78.3
			P_{cz}	1990	1800	1610	1460	1340	1260	1190	1110	1060	1030	1010	999	989
	10.0	48.7	P_{cx}	2820	2590	2370	2160	1960	1760	1580	1260	1000	808	661	549	462
			P_{cy}	2210	1740	1330	1010	786	621	502	345	250	190	149	120	98.8
			P_{cz}	2530	2310	2130	2000	1900	1840	1790	1720	1690	1660	1650	1640	1630
225 x 150	* 6.0	33.2	P_{cx}	1490	1440	1350	1260	1180	1100	1010	861	724	608	512	435	372
			P_{cy}	1190	951	741	574	449	357	290	200	146	111	87.4	70.4	57.9
			P_{cz}	1360	1240	1100	961	846	756	688	596	541	506	483	466	454
	* 8.0	43.2	P_{cx}	2380	2250	2090	1940	1790	1640	1500	1240	1020	836	695	583	495
			P_{cy}	1830	1420	1080	820	633	499	402	276	200	151	119	95.8	78.8
			P_{cz}	2130	1910	1690	1510	1370	1270	1190	1090	1030	997	972	955	943
	10.0	52.7	P_{cx}	3070	2870	2660	2450	2250	2050	1870	1520	1240	1020	841	703	595
			P_{cy}	2350	1820	1380	1040	803	633	510	349	253	192	150	121	99.6
			P_{cz}	2730	2470	2250	2080	1950	1870	1800	1720	1670	1640	1620	1600	1590
	12.0	61.7	P_{cx}	3590	3350	3100	2850	2610	2380	2150	1750	1420	1160	959	802	678
			P_{cy}	2780	2160	1640	1250	966	763	615	422	306	232	182	146	120
			P_{cz}	3200	2950	2770	2630	2540	2480	2430	2380	2340	2320	2310	2300	2290
250 x 200	* 6.0	40.3	P_{cx}	1580	1580	1500	1420	1350	1280	1200	1060	929	808	700	608	530
			P_{cy}	1440	1260	1090	925	780	657	555	404	304	236	188	153	127
			P_{cz}	1520	1440	1340	1240	1130	1020	928	775	669	597	547	510	484
	* 8.0	52.7	P_{cx}	2550	2510	2370	2230	2100	1960	1830	1580	1350	1150	983	842	725
			P_{cy}	2270	1950	1650	1380	1140	946	790	566	422	325	258	209	173
			P_{cz}	2430	2270	2100	1920	1750	1600	1470	1280	1160	1070	1020	975	945
	* 10.0	64.5	P_{cx}	3520	3410	3200	3000	2800	2610	2420	2060	1740	1460	1240	1050	899
			P_{cy}	3080	2630	2200	1820	1490	1230	1020	725	538	414	328	266	220
			P_{cz}	3310	3080	2850	2620	2420	2260	2120	1930	1800	1720	1670	1630	1600
	* 12.0	75.9	P_{cx}	4340	4180	3920	3660	3400	3160	2920	2460	2060	1720	1450	1230	1050
			P_{cy}	3790	3230	2690	2220	1810	1490	1240	879	652	501	397	322	266
			P_{cz}	4060	3790	3530	3300	3110	2950	2830	2670	2560	2490	2450	2410	2390

* Section is slender under axial compression and allowance has been made in calculating the compression resistance.

For explanation of table see Section 8.4.

Table 71

COMPRESSION

**DOUBLE CHANNELS BACK TO BACK
SUBJECT TO AXIAL COMPRESSION**

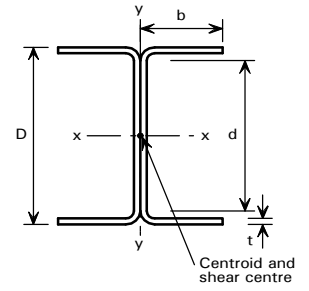

COMPRESSION RESISTANCE FOR GRADE 1.4462 (2205)

D x 2b mm	t mm	Mass per Metre kg	Axis	Compression Resistance, P_{cx} , P_{cy} , P_{cz} (kN)												
				for Effective Length L_E (m)												
				1.0	1.5	2.0	2.5	3.0	3.5	4.0	5.0	6.0	7.0	8.0	9.0	10.0
300 x 200	* 8.0	59.0	P_{cx}	2650	2650	2560	2440	2320	2210	2100	1880	1660	1470	1290	1130	992
			P_{cy}	2340	2010	1690	1410	1160	959	799	571	425	327	260	211	174
			P_{cz}	2530	2370	2200	2010	1830	1650	1510	1280	1130	1030	962	913	877
	* 10.0	72.4	P_{cx}	3820	3820	3630	3440	3260	3080	2900	2560	2230	1940	1680	1460	1270
			P_{cy}	3310	2800	2320	1890	1540	1260	1040	739	547	420	332	269	222
			P_{cz}	3600	3350	3080	2820	2570	2350	2180	1930	1660	1660	1590	1530	1500
	* 12.0	85.4	P_{cx}	4890	4860	4600	4340	4100	3860	3620	3160	2730	2350	2020	1740	1510
			P_{cy}	4200	3530	2900	2350	1900	1550	1280	903	666	511	403	326	269
			P_{cz}	4580	4250	3920	3610	3340	3120	2950	2700	2550	2450	2380	2330	2300
	15.0	103	P_{cx}	6040	5970	5640	5320	5010	4710	4410	3830	3290	2820	2410	2070	1790
			P_{cy}	5210	4390	3620	2940	2390	1950	1610	1140	840	645	509	412	340
			P_{cz}	5640	5260	4930	4650	4430	4260	4130	3950	3840	3760	3710	3680	3650
350 x 250	* 8.0	71.6	P_{cx}	2800	2800	2800	2720	2620	2520	2420	2230	2050	1870	1700	1540	1390
			P_{cy}	2670	2400	2140	1890	1660	1440	1250	946	729	575	463	380	317
			P_{cz}	2760	2640	2520	2380	2230	2080	1920	1640	1410	1240	1120	1020	955
	* 10.0	88.2	P_{cx}	4080	4080	4060	3890	3730	3580	3420	3120	2830	2550	2290	2050	1830
			P_{cy}	3830	3410	3010	2620	2260	1940	1670	1240	948	742	595	487	405
			P_{cz}	3990	3800	3600	3380	3150	2920	2700	2330	2060	1860	1720	1610	1540
	* 12.0	104	P_{cx}	5500	5500	5390	5160	4930	4710	4490	4050	3640	3240	2870	2550	2250
			P_{cy}	5090	4500	3930	3390	2890	2460	2100	1550	1170	913	729	595	494
			P_{cz}	5330	5050	4760	4450	4150	3850	3590	3160	2860	2650	2500	2390	2310
	* 15.0	127	P_{cx}	7300	7300	7090	6760	6440	6130	5820	5220	4640	4100	3610	3170	2790
			P_{cy}	6710	5910	5140	4410	3750	3170	2690	1970	1490	1160	926	755	627
			P_{cz}	7020	6640	6260	5880	5530	5220	4950	4540	4260	4070	3940	3840	3770
400 x 300	* 8.0	84.3	P_{cx}	2920	2920	2920	2920	2840	2760	2670	2510	2350	2190	2040	1890	1740
			P_{cy}	2910	2690	2470	2260	2060	1860	1670	1350	1080	877	720	599	505
			P_{cz}	2920	2840	2740	2640	2530	2410	2280	2020	1770	1550	1370	1230	1120
	* 10.0	104	P_{cx}	4290	4290	4290	4250	4110	3970	3840	3570	3320	3070	2820	2590	2360
			P_{cy}	4220	3870	3530	3200	2880	2570	2290	1810	1430	1150	936	775	651
			P_{cz}	4280	4130	3970	3800	3620	3430	3230	2840	2490	2210	1990	1820	1690
	* 12.0	123	P_{cx}	5820	5820	5820	5690	5490	5290	5100	4710	4340	3980	3630	3290	2990
			P_{cy}	5670	5170	4680	4210	3750	3320	2930	2280	1790	1420	1150	953	798
			P_{cz}	5780	5550	5310	5070	4810	4540	4270	3760	3340	3010	2770	2580	2440
	* 15.0	151	P_{cx}	8250	8250	8250	7940	7630	7330	7030	6450	5880	5330	4800	4320	3880
			P_{cy}	7950	7190	6470	5760	5090	4460	3900	2990	2320	1840	1480	1220	1020
			P_{cz}	8120	7770	7410	7040	6660	6290	5940	5320	4850	4500	4240	4050	3900

* Section is slender under axial compression and allowance has been made in calculating the compression resistance.

For explanation of table see Section 8.4.

Table 72

COMPRESSION

**EQUAL ANGLES
SUBJECT TO AXIAL COMPRESSION**

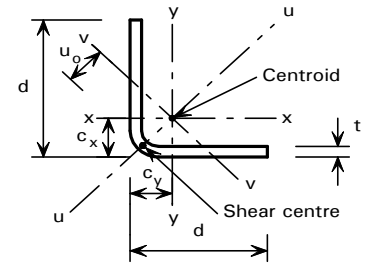

COMPRESSION RESISTANCE FOR GRADE 1.4462 (2205)

d x d mm	t mm	Mass per Metre kg	Axis	Compression Resistance, P_{cx} , P_{cy} , P_{ouz} , P_{cv} (kN)												
				for Effective Length L_E (m)												
				1.0	1.5	2.0	2.5	3.0	3.5	4.0	5.0	6.0	7.0	8.0	9.0	10.0
50 x 50	* 5.0	3.54	P_{cx}, P_{cy}	104	64.2	40.5	27.5	19.8	14.9	11.6	7.61	5.38	4.00	3.09	2.46	2.00
			P_{ouz}	107	83.2	59.4	42.6	31.6	24.1	19.0	12.6	8.92	6.65	5.15	4.10	3.34
			P_{cv}	51.3	25.6	15.1	9.97	7.06	5.26	4.07	2.64	1.85	1.37	1.06	0.838	0.681
	* 6.0	4.15	P_{cx}, P_{cy}	130	76.6	47.7	32.1	23.0	17.3	13.5	8.82	6.22	4.62	3.57	2.84	2.31
			P_{ouz}	145	106	73.2	51.5	37.7	28.6	22.4	14.8	10.5	7.78	6.02	4.79	3.90
			P_{cv}	58.2	28.6	16.8	11.0	7.79	5.80	4.48	2.91	2.04	1.51	1.16	0.919	0.747
	8.0	5.27	P_{cx}, P_{cy}	176	97.9	59.8	40.0	28.6	21.4	16.6	10.9	7.66	5.68	4.38	3.48	2.84
			P_{ouz}	218	148	97.3	66.9	48.4	36.5	28.5	18.7	13.2	9.78	7.55	6.00	4.88
			P_{cv}	66.5	32.0	18.7	12.2	8.60	6.39	4.93	3.19	2.23	1.65	1.27	1.01	0.817
	10.0	6.26	P_{cx}, P_{cy}	203	112	68.4	45.7	32.6	24.4	19.0	12.4	8.72	6.47	4.99	3.97	3.23
			P_{ouz}	262	176	114	78.4	56.6	42.6	33.2	21.7	15.3	11.4	8.77	6.97	5.67
			P_{cv}	67.9	32.4	18.8	12.3	8.66	6.42	4.95	3.20	2.24	1.65	1.27	1.01	0.819
75 x 75	* 6.0	6.52	P_{cx}, P_{cy}	216	175	132	98.0	73.6	56.8	45.0	30.1	21.5	16.1	12.5	10.0	8.17
			P_{ouz}	172	161	143	121	100	82.1	67.5	47.1	34.3	26.0	20.4	16.3	13.4
			P_{cv}	158	95.6	60.0	40.6	29.2	22.0	17.1	11.2	7.92	5.89	4.55	3.62	2.95
	* 8.0	8.43	P_{cx}, P_{cy}	333	255	182	130	96.7	74.0	58.3	38.7	27.6	20.6	16.0	12.8	10.4
			P_{ouz}	298	270	227	182	144	114	92.4	63.0	45.4	34.1	26.6	21.3	17.4
			P_{cv}	216	121	74.1	49.6	35.4	26.6	20.6	13.5	9.50	7.05	5.44	4.32	3.52
	* 10.0	10.2	P_{cx}, P_{cy}	453	330	227	159	117	89.1	70.0	46.3	32.9	24.5	19.0	15.2	12.4
			P_{ouz}	439	384	309	239	184	143	114	77.3	55.3	41.4	32.2	25.7	21.0
			P_{cv}	261	138	83.8	55.7	39.6	29.6	23.0	15.0	10.5	7.81	6.02	4.78	3.89
	12.0	11.9	P_{cx}, P_{cy}	566	396	265	184	134	102	80.0	52.8	37.4	27.9	21.6	17.2	14.1
			P_{ouz}	578	491	383	289	219	169	134	89.9	64.0	47.9	37.1	29.6	24.2
			P_{cv}	291	149	89.3	59.1	42.0	31.3	24.3	15.8	11.1	8.21	6.33	5.02	4.09
100 x 100	* 8.0	11.6	P_{cx}, P_{cy}	412	368	312	254	202	161	130	89.6	64.8	48.9	38.2	30.7	25.1
			P_{ouz}	312	302	286	264	236	206	178	132	99.6	77.0	61.0	49.4	40.8
			P_{cv}	347	249	170	119	87.1	66.2	51.9	34.3	24.4	18.2	14.1	11.2	9.16
	* 10.0	14.2	P_{cx}, P_{cy}	591	510	418	329	256	202	162	109	79.1	59.5	46.4	37.2	30.5
			P_{ouz}	483	464	430	384	332	282	237	170	126	96.5	75.9	61.2	50.3
			P_{cv}	468	313	205	141	102	77.5	60.6	39.9	28.2	21.0	16.3	13.0	10.6
	* 12.0	16.6	P_{cx}, P_{cy}	776	656	522	399	306	239	190	128	92.1	69.2	53.9	43.1	35.3
			P_{ouz}	675	640	581	505	425	353	292	205	150	114	89.7	72.1	59.1
			P_{cv}	582	365	232	158	114	86.1	67.2	44.1	31.2	23.2	17.9	14.3	11.6
	* 15.0	20.0	P_{cx}, P_{cy}	1070	872	665	494	372	288	228	153	109	82.0	63.7	50.9	41.6
			P_{ouz}	987	916	808	680	555	450	367	253	183	138	108	86.8	71.1
			P_{cv}	723	420	260	175	125	94.4	73.5	48.1	33.9	25.2	19.4	15.5	12.6
120 x 120	* 8.0	14.1	P_{cx}, P_{cy}	434	424	383	338	290	245	205	146	108	82.6	65.0	52.5	43.2
			P_{ouz}	309	302	294	283	269	251	230	188	150	121	98.3	81.0	67.6
			P_{cv}	410	337	259	193	146	113	89.7	60.1	43.0	32.2	25.0	20.0	16.4
	* 10.0	17.3	P_{cx}, P_{cy}	636	603	535	460	384	317	261	183	134	101	79.9	64.3	52.9
			P_{ouz}	492	481	464	440	408	371	331	257	199	157	125	102	85.1
			P_{cv}	577	452	329	238	177	135	107	71.5	50.9	38.1	29.6	23.6	19.3
	* 12.0	20.4	P_{cx}, P_{cy}	861	795	692	580	474	385	314	217	158	119	93.8	75.4	61.9
			P_{ouz}	702	684	654	610	554	491	429	323	245	190	151	122	101
			P_{cv}	749	558	390	276	203	155	121	80.8	57.4	42.9	33.3	26.5	21.7
	* 15.0	24.8	P_{cx}, P_{cy}	1230	1100	928	753	599	478	386	264	191	144	112	90.5	74.2
			P_{ouz}	1060	1020	959	873	771	666	568	414	308	236	186	150	124
			P_{cv}	1000	693	462	320	233	176	138	91.4	64.7	48.3	37.4	29.8	24.3

See Section 8.4.2 for guidance on calculating an effective length which allows for both the effects of end fixity and nominal end moments due to eccentricity of connection.

Slender sections must also be checked for the combined effects of the axial load and moment caused by the shift of neutral axis, see Section 8.4.2

* Section is slender under axial compression and allowance has been made in calculating the compression resistance.

For explanation of table see Section 8.4

Table 72

COMPRESSION

**EQUAL ANGLES
SUBJECT TO AXIAL COMPRESSION**

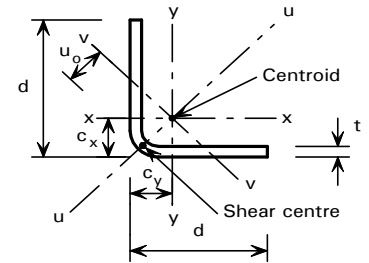

COMPRESSION RESISTANCE FOR GRADE 1.4462 (2205)

d x d mm	t mm	Mass per Metre kg	Axis	Compression Resistance, P_{cx} , P_{cy} , P_{ouz} , P_{cv} (kN)													
				for Effective Length L_E (m)													
				1.0	1.5	2.0	2.5	3.0	3.5	4.0	5.0	6.0	7.0	8.0	9.0	10.0	
150 x 150	* 8.0	17.9	P_{cx}, P_{cy}	459	459	451	421	388	353	316	247	192	150	120	98.6	81.8	
			P_{ouz}	295	289	285	280	274	267	258	236	210	183	157	135	116	
			P_{cv}	459	423	367	307	250	203	165	114	83.4	63.1	49.4	39.7	32.6	
	* 10.0	22.1	P_{cx}, P_{cy}	679	679	650	599	543	483	424	321	244	190	151	122	101	
			P_{ouz}	487	479	470	460	447	430	409	360	306	257	215	181	153	
			P_{cv}	679	598	502	404	320	254	205	140	101	76.3	59.5	47.8	39.1	
	* 12.0	26.1	P_{cx}, P_{cy}	928	928	867	788	702	614	530	392	294	227	180	145	120	
			P_{ouz}	714	702	689	670	645	612	574	486	401	328	269	224	188	
			P_{cv}	911	781	634	494	382	300	240	162	116	87.8	68.4	54.8	44.9	
	* 15.0	31.9	P_{cx}, P_{cy}	1350	1330	1210	1080	942	805	682	491	364	279	220	177	146	
			P_{ouz}	1110	1090	1060	1020	969	902	827	671	534	427	345	283	236	
			P_{cv}	1280	1050	813	609	461	357	283	190	136	102	79.5	63.5	52.0	
200 x 200	* 8.0	24.2	P_{cx}, P_{cy}	486	486	486	486	479	458	436	389	338	288	244	206	175	
			P_{ouz}	265	258	255	252	250	248	245	238	230	220	209	196	182	
			P_{cv}	486	486	468	433	394	353	312	238	182	141	113	91.9	76.1	
	* 10.0	30.0	P_{cx}, P_{cy}	727	727	727	727	698	662	624	543	459	382	317	265	223	
			P_{ouz}	458	447	442	437	432	427	420	404	384	359	331	301	272	
			P_{cv}	727	727	678	616	548	479	413	304	228	176	139	113	93.5	
	* 12.0	35.6	P_{cx}, P_{cy}	1010	1010	1010	992	940	885	826	701	579	473	388	322	270	
			P_{ouz}	696	683	674	666	658	647	635	603	561	512	460	408	361	
			P_{cv}	1010	993	905	808	703	601	509	367	272	208	164	132	109	
	* 15.0	43.7	P_{cx}, P_{cy}	1480	1480	1480	1420	1340	1240	1140	938	754	605	490	403	337	
			P_{ouz}	1130	1110	1090	1080	1060	1040	1010	938	847	747	651	563	488	
			P_{cv}	1480	1420	1270	1100	927	771	640	450	330	251	197	159	130	

See Section 8.4.2 for guidance on calculating an effective length which allows for both the effects of end fixity and nominal end moments due to eccentricity of connection.

Slender sections must also be checked for the combined effects of the axial load and moment caused by the shift of neutral axis, see Section 8.4.2

* Section is slender under axial compression and allowance has been made in calculating the compression resistance.

For explanation of table see Section 8.4

Table 73

COMPRESSION

**DOUBLE ANGLES BACK TO BACK
SUBJECT TO AXIAL COMPRESSION**

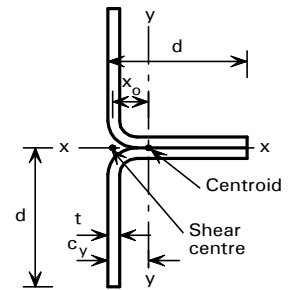

COMPRESSION RESISTANCE FOR GRADE 1.4462 (2205)

2d x d mm	t mm	Mass per Metre kg	Axis	Compression Resistance, P_{cx} , P_{cxz} , P_{cy} (kN)												
				for Effective Length L_E (m)												
				1.0	1.5	2.0	2.5	3.0	3.5	4.0	5.0	6.0	7.0	8.0	9.0	10.0
100 x 50	* 5.0	7.08	P_{cx}	212	155	112	82.7	62.6	48.8	38.9	26.4	19.0	14.4	11.2	9.00	7.38
			P_{cxz}	225	185	136	99.4	73.8	56.5	44.5	29.5	20.9	15.6	12.1	9.63	7.85
			P_{cy}	166	105	69.6	48.7	35.7	27.3	21.5	14.3	10.2	7.65	5.94	4.75	3.88
	* 6.0	8.30	P_{cx}	275	198	140	102	77.1	59.8	47.7	32.2	23.2	17.5	13.6	10.9	8.95
			P_{cxz}	309	242	173	123	90.9	69.2	54.3	35.9	25.4	18.9	14.6	11.7	9.50
			P_{cy}	207	127	82.8	57.4	41.9	31.9	25.1	16.7	11.9	8.88	6.89	5.50	4.49
	8.0	10.5	P_{cx}	405	283	197	142	106	82.3	65.4	44.0	31.6	23.8	18.5	14.8	12.2
			P_{cxz}	477	355	244	171	125	94.9	74.3	48.9	34.5	25.7	19.8	15.8	12.9
			P_{cy}	281	165	105	72.4	52.6	39.9	31.3	20.7	14.7	11.0	8.49	6.77	5.53
	10.0	12.5	P_{cx}	492	348	245	178	133	103	82.2	55.5	39.9	30.0	23.4	18.8	15.4
			P_{cxz}	584	441	307	216	158	120	94.0	61.9	43.8	32.5	25.1	20.0	16.3
			P_{cy}	326	190	120	82.8	60.1	45.5	35.7	23.6	16.7	12.5	9.68	7.72	6.30
150 x 75	* 6.0	13.0	P_{cx}	404	343	285	234	191	156	129	92.2	68.3	52.5	41.5	33.7	27.8
			P_{cxz}	343	332	308	270	226	186	153	107	78.2	59.3	46.3	37.2	30.5
			P_{cy}	358	279	212	161	124	98.5	79.4	54.5	39.5	30.0	23.5	18.9	15.5
	* 8.0	16.9	P_{cx}	631	524	426	341	274	222	182	127	94.1	72.0	56.8	45.9	37.9
			P_{cxz}	601	569	502	416	335	268	217	149	107	80.9	63.1	50.5	41.3
			P_{cy}	543	404	296	219	166	130	104	70.9	51.2	38.7	30.2	24.3	19.9
	* 10.0	20.4	P_{cx}	879	719	574	453	359	289	235	164	120	91.9	72.3	58.4	48.1
			P_{cxz}	895	825	701	563	443	351	281	191	137	102	80.1	64.0	52.3
			P_{cy}	732	525	373	272	204	158	126	85.4	61.5	46.3	36.1	29.0	23.8
	12.0	23.7	P_{cx}	1130	912	720	564	444	356	289	201	147	112	88.1	71.1	58.5
			P_{cxz}	1190	1070	895	707	550	432	346	233	167	125	97.3	77.7	63.5
			P_{cy}	908	633	441	317	237	183	145	98.0	70.3	52.9	41.2	33.0	27.1
200 x 100	* 8.0	23.2	P_{cx}	775	691	609	532	459	395	339	253	193	151	121	99.4	82.7
			P_{cxz}	616	606	590	562	517	461	403	301	227	175	139	112	92.8
			P_{cy}	712	601	496	404	328	268	221	156	115	88.9	70.3	56.9	47.0
	* 10.0	28.3	P_{cx}	1110	975	849	731	623	529	450	330	250	195	155	127	105
			P_{cxz}	957	939	903	835	742	642	547	397	295	226	178	143	118
			P_{cy}	1000	824	664	528	421	340	278	194	142	109	86.0	69.5	57.3
	* 12.0	33.2	P_{cx}	1460	1280	1100	939	792	666	563	410	308	239	190	155	128
			P_{cxz}	1340	1310	1240	1120	970	823	692	493	363	276	217	174	143
			P_{cy}	1300	1050	828	647	509	407	331	229	167	127	100	81.0	66.7
	* 15.0	40.0	P_{cx}	2040	1760	1500	1260	1050	878	736	531	397	307	243	198	164
			P_{cxz}	1980	1910	1760	1550	1320	1100	910	639	467	354	277	222	182
			P_{cy}	1770	1390	1060	811	629	497	401	276	200	152	119	96.2	79.1
240 x 120	* 8.0	28.2	P_{cx}	857	785	717	650	585	523	466	368	291	234	191	158	133
			P_{cxz}	606	599	591	580	563	539	505	422	340	273	221	182	151
			P_{cy}	806	713	623	538	460	392	334	246	187	145	116	95.3	79.2
	* 10.0	34.6	P_{cx}	1240	1130	1020	913	812	718	632	489	383	305	247	203	170
			P_{cxz}	968	957	941	916	873	813	739	585	457	359	288	235	194
			P_{cy}	1150	1000	862	729	612	513	432	313	235	182	144	117	97.7
	* 12.0	40.8	P_{cx}	1660	1500	1340	1190	1050	922	804	614	476	377	304	250	209
			P_{cxz}	1380	1370	1340	1290	1200	1090	973	747	572	445	354	288	238
			P_{cy}	1530	1310	1110	921	761	630	525	376	280	216	171	139	115
	* 15.0	49.5	P_{cx}	2340	2100	1860	1640	1430	1240	1070	806	619	486	391	320	267
			P_{cxz}	2090	2060	2000	1880	1710	1520	1330	989	745	575	455	368	303
			P_{cy}	2120	1790	1480	1200	973	794	655	463	342	262	207	168	138

See Section 8.4.2 for guidance on calculating an effective length which allows for both the effects of end fixity and nominal end moments due to eccentricity of connection.

Slender sections must also be checked for the combined effects of the axial load and moment caused by the shift of neutral axis, see Section 8.4.2.

* Section is slender under axial compression and allowance has been made in calculating the compression resistance.

Table 73

COMPRESSION

**DOUBLE ANGLES BACK TO BACK
SUBJECT TO AXIAL COMPRESSION**

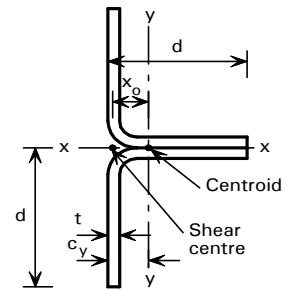

COMPRESSION RESISTANCE FOR GRADE 1.4462 (2205)

2d x d mm	t mm	Mass per Metre kg	Axis	Compression Resistance, P_{cx} , P_{czz} , P_{cy} (kN)												
				for Effective Length L_E (m)												
				1.0	1.5	2.0	2.5	3.0	3.5	4.0	5.0	6.0	7.0	8.0	9.0	10.0
300 x 150	* 8.0	35.8	P_{cx}	918	889	833	780	727	676	625	530	446	374	316	268	229
			P_{czz}	577	569	564	559	553	545	536	507	464	410	355	304	261
			P_{cy}	908	834	762	693	626	562	501	397	316	254	208	172	145
	* 10.0	44.1	P_{cx}	1360	1290	1210	1120	1040	955	875	729	603	499	416	351	298
			P_{czz}	954	943	934	924	911	892	867	790	687	581	487	409	346
			P_{cy}	1320	1200	1090	974	867	767	675	522	409	325	263	217	182
	* 12.0	52.2	P_{cx}	1860	1740	1620	1490	1370	1250	1140	936	764	627	519	435	368
			P_{czz}	1400	1390	1370	1360	1330	1290	1240	1080	906	747	615	511	429
			P_{cy}	1780	1600	1430	1270	1120	975	848	645	498	393	317	260	217
	* 15.0	63.7	P_{cx}	2690	2490	2290	2100	1910	1730	1560	1260	1010	822	676	563	475
			P_{czz}	2170	2150	2130	2090	2030	1940	1810	1520	1230	993	807	664	554
			P_{cy}	2530	2250	1980	1730	1490	1280	1100	821	626	490	393	321	267
400 x 200	* 8.0	48.5	P_{cx}	972	972	961	920	882	843	806	732	661	593	529	471	419
			P_{czz}	520	507	501	498	495	492	490	483	474	463	447	428	404
			P_{cy}	972	963	910	860	810	762	714	621	536	460	394	339	293
	* 10.0	59.9	P_{cx}	1460	1460	1420	1350	1290	1230	1170	1050	931	824	726	638	562
			P_{czz}	896	877	869	863	857	852	845	829	805	772	726	671	611
			P_{cy}	1460	1420	1330	1250	1170	1090	1010	862	729	615	520	443	380
	* 12.0	71.1	P_{cx}	2010	2010	1930	1830	1740	1650	1560	1390	1220	1070	931	812	710
			P_{czz}	1360	1340	1330	1320	1310	1300	1290	1250	1200	1120	1020	917	814
			P_{cy}	2010	1930	1800	1680	1560	1440	1330	1110	925	770	645	545	464
	* 15.0	87.4	P_{cx}	2960	2950	2790	2640	2500	2350	2210	1940	1680	1450	1250	1080	936
			P_{czz}	2200	2170	2160	2140	2120	2100	2070	1990	1850	1660	1470	1280	1110
			P_{cy}	2960	2780	2580	2380	2190	2000	1820	1490	1220	999	827	693	587

See Section 8.4.2 for guidance on calculating an effective length which allows for both the effects of end fixity and nominal end moments due to eccentricity of connection.

Slender sections must also be checked for the combined effects of the axial load and moment caused by the shift of neutral axis, see Section 8.4.2.

* Section is slender under axial compression and allowance has been made in calculating the compression resistance.

Table 74

TENSION

**EQUAL ANGLES
SUBJECT TO AXIAL TENSION**

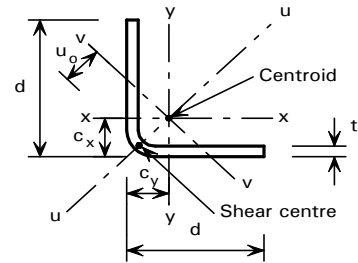

TENSION CAPACITY FOR GRADE 1.4462 (2205)

d x d mm	t mm	Mass per Metre kg	Radius of Gyration v-v axis cm	Gross Area cm ²	Weld or Bolt Size	Holes Deducted From Angle		Equivalent Tension Area cm ²	Tension Capacity kN
						No.	Diameter mm		
50 x 50	5.0	3.54	0.892	4.48	Weld	0	-	3.89	178
					M12	1	13	2.84	130
50 x 50	6.0	4.15	0.861	5.25	Weld	0	-	4.58	210
					M12	1	13	3.35	153
50 x 50	8.0	5.27	0.797	6.67	Weld	0	-	5.87	270
					M12	1	13	4.30	197
50 x 50	10.0	6.26	0.732	7.93	Weld	0	-	7.05	324
					M12	1	13	5.16	237
75 x 75	6.0	6.52	1.38	8.25	Weld	0	-	7.13	327
					M16	1	18	5.30	243
					M20	1	22	5.06	232
75 x 75	8.0	8.43	1.32	10.7	Weld	0	-	9.27	426
					M16	1	18	6.90	317
					M20	1	22	6.58	302
75 x 75	10.0	10.2	1.26	12.9	Weld	0	-	11.3	519
					M16	1	18	8.41	387
					M20	1	22	8.01	368
75 x 75	12.0	11.9	1.20	15.0	Weld	0	-	13.2	607
					M16	1	18	9.85	452
					M20	1	22	9.37	430
100 x 100	8.0	11.6	1.84	14.7	Weld	0	-	12.7	582
					M20	1	22	9.58	440
					M24	1	26	9.26	425
100 x 100	10.0	14.2	1.78	17.9	Weld	0	-	15.5	715
					M20	1	22	11.8	541
					M24	1	26	11.4	522
100 x 100	12.0	16.6	1.72	21.0	Weld	0	-	18.3	842
					M20	1	22	13.9	637
					M24	1	26	13.4	615
100 x 100	15.0	20.0	1.63	25.3	Weld	0	-	22.2	1020
					M20	1	22	16.9	775
					M24	1	26	16.3	748
120 x 120	8.0	14.1	2.25	17.9	Weld	0	-	15.4	707
					M20	1	22	12.0	550
					M24	1	26	11.7	536
120 x 120	10.0	17.3	2.20	21.9	Weld	0	-	18.9	871
					M20	1	22	14.8	679
					M24	1	26	14.4	660
120 x 120	12.0	20.4	2.14	25.8	Weld	0	-	22.4	1030
					M20	1	22	17.5	803
					M24	1	26	17.0	781
120 x 120	15.0	24.8	2.05	31.3	Weld	0	-	27.3	1260
					M20	1	22	21.4	982
					M24	1	26	20.8	955
150 x 150	8.0	17.9	2.87	22.7	Weld	0	-	19.5	895
					M20	1	22	15.6	716
					M20	2	22	13.8	635
					M24	1	26	15.3	701
150 x 150	10.0	22.1	2.82	27.9	Weld	0	-	24.0	1110
					M20	1	22	19.3	886
					M20	2	22	17.1	784
					M24	1	26	18.9	867

The capacity of the bolts must also be checked.

For explanation of table see Section 8.5

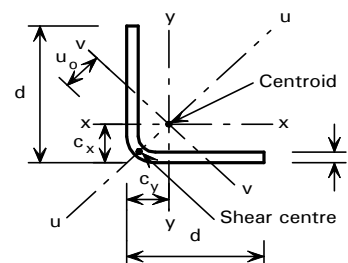
Table 74**TENSION****EQUAL ANGLES
SUBJECT TO AXIAL TENSION****TENSION CAPACITY FOR GRADE 1.4462 (2205)**

d x d mm	t mm	Mass per Metre kg	Radius of Gyration v-v axis cm	Gross Area cm ²	Weld or Bolt Size	Holes Deducted From Angle		Equivalent Tension Area cm ²	Tension Capacity kN
						No.	Diameter mm		
150 x 150	12.0	26.1	2.76	33.0	Weld	0	-	28.5	1310
					M20	1	22	22.9	1050
					M20	2	22	20.2	930
					M24	1	26	22.4	1030
150 x 150	15.0	31.9	2.67	40.3	Weld	0	-	35.0	1610
					M20	1	22	28.1	1290
					M20	2	22	24.8	1140
					M24	1	26	27.5	1270
200 x 200	8.0	24.2	3.90	30.7	Weld	0	-	26.3	1210
					M20	3	22	18.1	830
					M24	1	26	21.3	977
					M24	2	26	19.2	882
200 x 200	10.0	30.0	3.85	37.9	Weld	0	-	32.5	1500
					M20	3	22	22.4	1030
					M24	1	26	26.4	1210
					M24	2	26	23.8	1090
200 x 200	12.0	35.6	3.79	45.0	Weld	0	-	38.7	1780
					M20	3	22	26.6	1220
					M24	1	26	31.4	1440
					M24	2	26	28.3	1300
200 x 200	15.0	43.7	3.71	55.3	Weld	0	-	47.7	2200
					M20	3	22	32.8	1510
					M24	1	26	38.8	1780
					M24	2	26	34.9	1600

The capacity of the bolts must also be checked.

For explanation of table see Section 8.5

Table 75

TENSION
TWO EQUAL ANGLES
BACK TO BACK
SUBJECT TO AXIAL TENSION

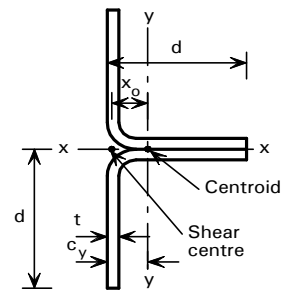

TENSION CAPACITY FOR GRADE 1.4462 (2205)

2d x d mm	t mm	Mass per Metre kg	Radius of Gyration		Gross Area cm ²	Weld or Bolt Size	Holes Deducted From Angle		Gusset Between Angles		Gusset On Back of Angles	
			Axis x-x cm	Axis y-y cm			No.	Diameter mm	Equivalent Tension Area cm ²	Tension Capacity kN	Equivalent Tension Area cm ²	Tension Capacity kN
100 x 50	5.0	7.08	2.17	1.55	8.96	Weld M12	0	-	8.37	384	7.77	357
							1	13	6.67	306	5.68	261
100 x 50	6.0	8.30	2.20	1.53	10.5	Weld M12	0	-	9.83	452	9.16	421
							1	13	7.82	359	6.69	307
100 x 50	8.0	10.5	2.26	1.50	13.3	Weld M12	0	-	12.5	577	11.7	540
							1	13	9.93	456	8.59	395
100 x 50	10.0	12.5	2.34	1.47	15.9	Weld M12	0	-	15.0	688	14.1	648
							1	13	11.8	542	10.3	475
150 x 75	6.0	13.0	3.21	2.34	16.5	Weld M16	0	-	15.4	707	14.3	655
							1	18	12.5	573	10.6	487
							1	22	12.0	551	10.1	465
150 x 75	8.0	16.9	3.27	2.31	21.3	Weld M16	0	-	19.9	917	18.5	852
							1	18	16.1	741	13.8	634
							1	22	15.5	712	13.2	605
150 x 75	10.0	20.4	3.33	2.28	25.9	Weld M16	0	-	24.2	1110	22.6	1040
							1	18	19.5	898	16.8	774
							1	22	18.7	862	16.0	737
150 x 75	12.0	23.7	3.40	2.25	30.0	Weld M16	0	-	28.2	1300	26.4	1220
							1	18	22.7	1040	19.7	905
							1	22	21.7	1000	18.7	861
200 x 100	8.0	23.2	4.28	3.12	29.3	Weld M20	0	-	27.3	1260	25.3	1170
							1	22	22.5	1030	19.2	881
							1	26	21.8	1010	18.5	851
200 x 100	10.0	28.3	4.33	3.09	35.9	Weld M20	0	-	33.5	1540	31.1	1430
							1	22	27.5	1260	23.5	1080
							1	26	26.7	1230	22.7	1050
200 x 100	12.0	33.2	4.40	3.06	42.0	Weld M20	0	-	39.3	1810	36.6	1680
							1	22	32.2	1480	27.7	1280
							1	26	31.3	1440	26.8	1230
200 x 100	15.0	40.0	4.49	3.02	50.7	Weld M20	0	-	47.6	2190	44.5	2050
							1	22	38.9	1790	33.7	1550
							1	26	37.7	1730	32.5	1500
240 x 120	8.0	28.2	5.09	3.77	35.7	Weld M20	0	-	33.3	1530	30.8	1420
							1	22	28.1	1290	24.0	1100
							1	26	27.4	1260	23.3	1070
240 x 120	10.0	34.6	5.14	3.74	43.9	Weld M20	0	-	40.9	1880	37.9	1740
							1	22	34.5	1590	29.5	1360
							1	26	33.7	1550	28.7	1320
240 x 120	12.0	40.8	5.20	3.71	51.6	Weld M20	0	-	48.2	2220	44.8	2060
							1	22	40.6	1870	34.9	1610
							1	26	39.7	1830	34.0	1560
240 x 120	15.0	49.5	5.29	3.67	62.7	Weld M20	0	-	58.7	2700	54.7	2510
							1	22	49.4	2270	42.7	1970
							1	26	48.2	2220	41.5	1910
300 x 150	8.0	35.8	6.31	4.74	45.3	Weld M20	0	-	42.1	1940	38.9	1790
							1	22	36.5	1680	31.2	1430
							2	22	33.0	1520	27.6	1270
							1	26	35.8	1650	30.5	1400
300 x 150	10.0	44.1	6.36	4.71	55.9	Weld M20	0	-	52.0	2390	48.1	2210
							1	22	45.0	2070	38.5	1770
							2	22	40.6	1870	34.1	1570
							1	26	44.2	2030	37.7	1740

The capacity of the bolts must also be checked.

For explanation of table see Section 8.5

Table 75

TENSION
TWO EQUAL ANGLES
BACK TO BACK
SUBJECT TO AXIAL TENSION

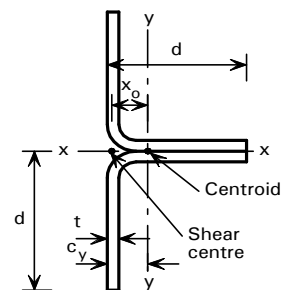

TENSION CAPACITY FOR GRADE 1.4462 (2205)

2d x d mm	t mm	Mass per Metre kg	Radius of Gyration		Gross Area cm ²	Weld or Bolt Size	Holes Deducted From Angle		Gusset Between Angles		Gusset On Back of Angles	
			Axis x-x cm	Axis y-y cm			No.	Diameter mm	Equivalent Tension Area cm ²	Tension Capacity kN	Equivalent Tension Area cm ²	Tension Capacity kN
300 x 150	12.0	52.2	6.42	4.68	66.0	Weld	0	-	61.5	2830	57.0	2620
						M20	1	22	53.2	2450	45.7	2100
						M20	2	22	48.0	2210	40.5	1860
						M24	1	26	52.3	2400	44.8	2060
300 x 150	15.0	63.7	6.50	4.64	80.7	Weld	0	-	75.3	3460	70.0	3220
						M20	1	22	65.2	3000	56.2	2590
						M20	2	22	58.6	2690	49.6	2280
						M24	1	26	64.0	2940	55.0	2530
400 x 200	8.0	48.5	8.35	6.35	61.3	Weld	0	-	56.9	2620	52.5	2420
						M20	3	22	43.4	2000	36.1	1660
						M24	1	26	49.8	2290	42.5	1960
						M24	2	26	45.7	2100	38.4	1760
400 x 200	10.0	59.9	8.40	6.32	75.9	Weld	0	-	70.5	3240	65.1	2990
						M20	3	22	53.7	2470	44.7	2060
						M24	1	26	61.7	2840	52.7	2430
						M24	2	26	56.5	2600	47.5	2190
400 x 200	12.0	71.1	8.45	6.30	90.0	Weld	0	-	83.7	3850	77.4	3560
						M20	3	22	63.7	2930	53.2	2450
						M24	1	26	73.3	3370	62.8	2890
						M24	2	26	67.0	3080	56.5	2600
400 x 200	15.0	87.4	8.53	6.26	110	Weld	0	-	103	4740	95.5	4390
						M20	3	22	78.2	3600	65.5	3010
						M24	1	26	90.2	4150	77.5	3570
						M24	2	26	82.4	3790	69.7	3210

The capacity of the bolts must also be checked.

For explanation of table see Section 8.5

Table 76

BENDING

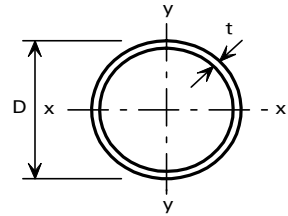
CIRCULAR HOLLOW SECTIONS
SUBJECT TO BENDING

MOMENT AND SHEAR CAPACITY FOR GRADE 1.4462 (2205)

D mm	t mm	Mass per Metre kg	Section Classification	Moment Capacity M_c kNm	Second Moment Of Area I_x, I_y cm ⁴	Shear Capacity P_v kN
21.3	1.0	0.50	Plastic	<i>0.171</i>	0.329	10.6
	1.2	0.60	Plastic	<i>0.199</i>	0.384	12.5
	1.6	0.78	Plastic	<i>0.251</i>	0.484	16.4
	2.0	0.96	Plastic	<i>0.296</i>	0.571	20.1
	2.3	1.08	Plastic	<i>0.326</i>	0.629	22.7
33.7	1.0	0.81	Compact	<i>0.450</i>	1.37	17.0
	1.6	1.27	Plastic	<i>0.683</i>	2.08	26.7
	2.0	1.57	Plastic	<i>0.823</i>	2.51	33.0
	2.5	1.94	Plastic	<i>0.983</i>	3.00	40.6
	3.2	2.42	Plastic	<i>1.18</i>	3.60	50.8
42.4	1.0	1.03	Semi-compact	0.605	2.79	21.5
	1.6	1.62	Compact	<i>1.11</i>	4.27	34.0
	2.0	2.01	Plastic	<i>1.35</i>	5.19	42.0
	2.6	2.57	Plastic	<i>1.68</i>	6.46	53.8
	3.2	3.11	Plastic	<i>1.98</i>	7.62	65.3
48.3	1.0	1.17	Semi-compact	0.792	4.16	24.6
	1.6	1.85	Compact	<i>1.46</i>	6.41	38.9
	2.0	2.30	Compact	<i>1.79</i>	7.81	48.2
	2.6	2.95	Plastic	<i>2.23</i>	9.78	61.8
	3.2	3.58	Plastic	<i>2.65</i>	11.6	75.1
60.3	1.0	1.47	Semi-compact	1.25	8.19	30.9
	1.6	2.33	Semi-compact	1.94	12.7	48.9
	2.0	2.89	Compact	<i>2.85</i>	15.6	60.7
	2.6	3.72	Plastic	<i>3.60</i>	19.7	78.0
	3.2	4.53	Plastic	<i>4.30</i>	23.5	95.1
	4.0	5.59	Plastic	<i>5.16</i>	28.2	117
	5.0	6.86	Plastic	<i>6.13</i>	33.5	143
76.1	1.0	1.86	Semi-compact	2.01	16.6	39.1
	1.6	2.96	Semi-compact	3.14	26.0	62.0
	2.0	3.68	Semi-compact	3.87	32.0	77.1
	2.6	4.74	Compact	<i>5.89</i>	40.6	99.4
	3.2	5.79	Plastic	<i>7.08</i>	48.8	121
	4.0	7.16	Plastic	<i>8.57</i>	59.1	150
	5.0	8.82	Plastic	<i>10.3</i>	70.9	184
88.9	1.0	2.18	Semi-compact	2.76	26.7	45.7
	1.6	3.47	Semi-compact	4.33	41.8	72.7
	2.0	4.31	Semi-compact	5.34	51.6	90.4
	2.6	5.57	Semi-compact	6.80	65.7	116
	3.2	6.81	Compact	<i>9.84</i>	79.2	142
	4.0	8.43	Plastic	<i>12.0</i>	96.3	176
	5.0	10.4	Plastic	<i>14.5</i>	116	218
101.6	1.0	2.50	Semi-compact	3.62	40.0	52.3
	1.6	3.97	Semi-compact	5.69	62.8	83.2
	2.0	4.94	Semi-compact	7.03	77.6	103
	2.6	6.39	Semi-compact	8.98	99.1	133
	3.2	7.81	Compact	<i>13.0</i>	119	163
	4.0	9.69	Compact	<i>15.9</i>	146	203
	5.0	12.0	Plastic	<i>19.3</i>	177	251

M_c values in *italic type* are governed by $1.2p_y Z$ and a higher value may be used in some circumstances.

For explanation of table see Section 8.6.

Table 76

BENDING

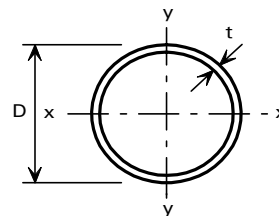
CIRCULAR HOLLOW SECTIONS
SUBJECT TO BENDING

MOMENT AND SHEAR CAPACITY FOR GRADE 1.4462 (2205)

D mm	t mm	Mass per Metre kg	Section Classification	Moment Capacity M_c kNm	Second Moment Of Area I_x, I_y cm ⁴	Shear Capacity P_v kN
114.3	1.2	3.37	Semi-compact	5.49	68.2	70.6
	1.6	4.48	Semi-compact	7.24	90.0	93.8
	2.0	5.57	Semi-compact	8.96	111	116
	2.6	7.21	Semi-compact	11.5	142	151
	3.2	8.82	Semi-compact	13.9	172	184
	4.0	10.9	Compact	<i>20.4</i>	211	229
	5.0	13.6	Plastic	<i>24.8</i>	256	284
139.7	1.2	4.12	Semi-compact	8.25	125	86.5
	1.6	5.48	Semi-compact	10.9	165	114
	2.0	6.84	Semi-compact	13.5	205	143
	2.6	8.85	Semi-compact	17.3	263	185
	3.2	10.8	Semi-compact	21.1	319	227
	4.0	13.5	Semi-compact	25.9	392	282
	5.0	16.7	Compact	<i>38.0</i>	480	350
168.3	1.6	6.62	Semi-compact	15.9	291	138
	2.0	8.25	Semi-compact	19.7	361	173
	2.6	10.7	Semi-compact	25.4	464	224
	3.2	13.1	Semi-compact	30.9	565	274
	4.0	16.3	Semi-compact	38.1	697	341
	5.0	20.3	Compact	<i>56.1</i>	855	424
219.1	2.0	10.8	Semi-compact	33.7	803	225
	2.6	14.0	Semi-compact	43.5	1040	292
	3.2	17.1	Semi-compact	53.1	1260	359
	4.0	21.4	Semi-compact	65.7	1560	447
	5.0	26.6	Semi-compact	81.0	1930	556
273	2.6	17.4	Semi-compact	68.0	2020	365
	3.2	21.4	Semi-compact	83.2	2470	449
	4.0	26.7	Semi-compact	103	3060	559
	5.0	33.3	Semi-compact	127	3780	697

M_c values in *italic type* are governed by $1.2p_y Z$ and a higher value may be used in some circumstances.

For explanation of table see Section 8.6.

Table 77

BENDING

**RECTANGULAR HOLLOW SECTIONS
SUBJECT TO BENDING**

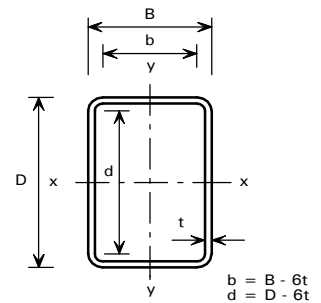

MOMENT CAPACITY AND LIMITING LENGTHS FOR GRADE 1.4462 (2205)

D x B mm	t mm	Mass per Metre kg	Section Classification		Moment Capacity		Limiting Length L _c m	Second Moment Of Area		Shear Capacity P _v kN
			Bending About x-x Axis	Bending About y-y Axis	M _{cx} kNm	M _{cy} kNm		I _x cm ⁴	I _y cm ⁴	
50 x 25	1.5	1.63	Plastic	Slender	<i>1.41</i>	<i>0.725</i>	2.21	6.41	2.19	38.0
	2.0	2.11	Plastic	Compact	<i>1.75</i>	<i>1.16</i>	2.20	7.95	2.70	49.1
60 x 30	2.0	2.58	Plastic	Slender	<i>2.65</i>	<i>1.44</i>	2.65	14.4	4.92	60.1
	3.0	3.68	Plastic	Plastic	<i>3.51</i>	<i>2.37</i>	2.61	19.1	6.44	85.6
80 x 40	2.0	3.53	Plastic	Slender	<i>5.00</i>	<i>2.32</i>	3.55	36.2	12.4	82.2
	3.0	5.10	Plastic	Semi-compact	<i>6.86</i>	<i>3.89</i>	3.52	49.7	16.9	118
	4.0	6.54	Plastic	Plastic	<i>8.32</i>	<i>5.62</i>	3.48	60.3	20.4	152
100 x 50	2.0	4.48	Semi-compact	Slender	<i>6.74</i>	<i>3.33</i>	6.82	73.2	25.2	104
	3.0	6.52	Plastic	Slender	<i>11.3</i>	<i>5.80</i>	4.42	102	35.1	151
	4.0	8.43	Plastic	Compact	<i>14.0</i>	<i>9.30</i>	4.39	127	43.2	196
	5.0	10.2	Plastic	Plastic	<i>16.3</i>	<i>11.0</i>	4.36	147	49.7	237
	6.0	11.9	Plastic	Plastic	<i>18.0</i>	<i>12.1</i>	4.31	162	54.7	276
150 x 75	3.0	10.1	Semi-compact	Slender	<i>22.7</i>	<i>11.2</i>	10.2	370	127	234
	4.0	13.2	Plastic	Slender	<i>34.8</i>	<i>16.7</i>	6.64	472	161	306
	5.0	16.1	Plastic	Slender	<i>41.5</i>	<i>22.5</i>	6.62	563	192	375
	6.0	19.0	Plastic	Compact	<i>47.4</i>	<i>31.4</i>	6.59	643	218	441
	8.0	24.2	Plastic	Plastic	<i>57.0</i>	<i>38.4</i>	6.51	774	260	564
150 x 100	3.0	11.3	Slender	Slender	<i>25.8</i>	<i>16.5</i>	21.6	451	243	236
	4.0	14.8	Compact	Slender	<i>42.6</i>	<i>24.5</i>	13.0	578	311	309
	5.0	18.1	Plastic	Slender	<i>51.1</i>	<i>32.8</i>	13.1	694	373	379
	6.0	21.3	Plastic	Compact	<i>58.8</i>	<i>46.1</i>	13.1	799	428	447
	8.0	27.4	Plastic	Plastic	<i>71.8</i>	<i>57.5</i>	13.1	976	521	574
200 x 100	4.0	17.9	Semi-compact	Slender	<i>53.9</i>	<i>26.6</i>	13.6	1170	403	417
	5.0	22.1	Plastic	Slender	<i>78.1</i>	<i>36.3</i>	8.87	1420	485	513
	6.0	26.1	Plastic	Slender	<i>90.6</i>	<i>46.4</i>	8.84	1640	561	607
	8.0	33.7	Plastic	Compact	<i>112</i>	<i>74.4</i>	8.79	2030	690	785
	10.0	40.8	Plastic	Plastic	<i>130</i>	<i>87.7</i>	8.71	2360	795	951
200 x 125	4.0	19.5	Slender	Slender	<i>59.9</i>	<i>35.9</i>	23.6	1360	666	419
	5.0	24.0	Compact	Slender	<i>91.3</i>	<i>48.8</i>	14.7	1650	805	516
	6.0	28.5	Plastic	Slender	<i>106</i>	<i>62.3</i>	14.7	1920	935	611
	8.0	36.9	Plastic	Compact	<i>132</i>	<i>100</i>	14.8	2400	1160	793
	10.0	44.8	Plastic	Plastic	<i>154</i>	<i>118</i>	14.8	2810	1360	963
250 x 125	6.0	33.2	Plastic	Slender	<i>147</i>	<i>67.1</i>	11.1	3340	1150	773
	8.0	43.2	Plastic	Slender	<i>185</i>	<i>98.6</i>	11.0	4210	1440	1010
	10.0	52.7	Plastic	Compact	<i>219</i>	<i>145</i>	11.0	4970	1690	1230
	12.0	61.7	Plastic	Plastic	<i>247</i>	<i>166</i>	10.9	5610	1900	1440
	15.0	74.1	Plastic	Plastic	<i>281</i>	<i>188</i>	10.8	6360	2140	1730
250 x 150	6.0	35.6	Compact	Slender	<i>167</i>	<i>85.3</i>	16.7	3790	1730	776
	8.0	46.4	Plastic	Slender	<i>211</i>	<i>125</i>	16.7	4800	2190	1010
	10.0	56.6	Plastic	Compact	<i>251</i>	<i>185</i>	16.7	5690	2580	1240
	12.0	66.4	Plastic	Plastic	<i>285</i>	<i>213</i>	16.7	6460	2930	1450
	15.0	80.1	Plastic	Plastic	<i>326</i>	<i>245</i>	16.6	7400	3340	1750
300 x 150	6.0	40.3	Semi-compact	Slender	<i>181</i>	<i>89.9</i>	20.5	5930	2040	938
	8.0	52.7	Plastic	Slender	<i>278</i>	<i>133</i>	13.3	7560	2590	1230
	10.0	64.5	Plastic	Slender	<i>331</i>	<i>179</i>	13.2	9010	3070	1500
	12.0	75.9	Plastic	Compact	<i>378</i>	<i>251</i>	13.2	10300	3500	1770
	15.0	91.9	Plastic	Plastic	<i>438</i>	<i>296</i>	13.1	11900	4030	2140
300 x 200	6.0	45.0	Slender	Slender	<i>206</i>	<i>132</i>	43.2	7230	3900	944
	8.0	59.0	Compact	Slender	<i>340</i>	<i>195</i>	26.0	9260	4990	1240
	10.0	72.4	Plastic	Slender	<i>409</i>	<i>262</i>	26.1	11100	5970	1520
	12.0	85.4	Plastic	Compact	<i>470</i>	<i>368</i>	26.2	12800	6850	1790
	15.0	103	Plastic	Plastic	<i>551</i>	<i>438</i>	26.3	15000	8000	2180

Moment capacity values in *italic type* are governed by 1.2p_yZ and a higher value may be used in some circumstances.

Lengths above the limiting length L_c should be checked for lateral torsional buckling.

For explanation of table see Section 8.6.

Table 77

BENDING

**RECTANGULAR HOLLOW SECTIONS
SUBJECT TO BENDING**

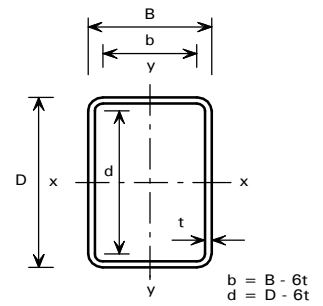

MOMENT CAPACITY AND LIMITING LENGTHS FOR GRADE 1.4462 (2205)

D x B mm	t mm	Mass per Metre kg	Section Classification		Moment Capacity		Limiting Length L _c m	Second Moment Of Area		Shear Capacity P _v kN
			Bending About x-x Axis	Bending About y-y Axis	M _{cx} kNm	M _{cy} kNm		I _x cm ⁴	I _y cm ⁴	
350 x 175	6.0	47.4	Slender	Slender	247	114	24.6	9600	3320	1100
	8.0	62.2	Plastic	Slender	388	172	15.5	12300	4240	1450
	10.0	76.4	Plastic	Slender	466	233	15.5	14800	5070	1780
	12.0	90.1	Plastic	Slender	537	295	15.4	17100	5810	2100
	15.0	109	Plastic	Plastic	631	420	15.3	20000	6780	2550
350 x 200	6.0	49.8	Slender	Slender	257	137	35.2	10500	4460	1110
	8.0	65.3	Compact	Slender	425	205	20.8	13500	5720	1450
	10.0	80.3	Plastic	Slender	512	277	20.8	16200	6870	1790
	12.0	94.8	Plastic	Slender	591	352	20.8	18800	7920	2110
	15.0	115	Plastic	Plastic	697	502	20.8	22100	9290	2570
400 x 200	6.0	54.5	Slender	Slender	298	141	33.7	14500	5030	1270
	8.0	71.6	Semi-compact	Slender	431	213	27.3	18800	6460	1670
	10.0	88.2	Plastic	Slender	625	290	17.7	22700	7780	2060
	12.0	104	Plastic	Slender	724	371	17.7	26200	8980	2430
	15.0	127	Plastic	Semi-compact	857	486	17.6	31100	10600	2970
400 x 250	6.0	59.3	Slender	Slender	315	192	64.0	16900	8250	1270
	8.0	78.0	Slender	Slender	478	287	47.2	21800	10700	1680
	10.0	96.1	Compact	Slender	730	390	29.4	26500	12900	2070
	12.0	113	Plastic	Slender	849	498	29.5	30800	15000	2450
	15.0	139	Plastic	Semi-compact	1010	653	29.5	36600	17800	3000

Moment capacity values in *italic type* are governed by 1.2p_yZ and a higher value may be used in some circumstances.

Lengths above the limiting length L_c should be checked for lateral torsional buckling.

For explanation of table see Section 8.6.

Table 78

BENDING

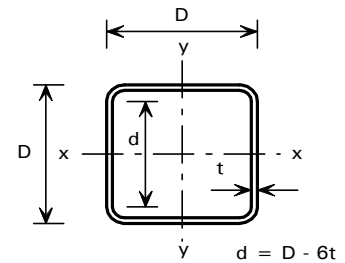
SQUARE HOLLOW SECTIONS
SUBJECT TO BENDING

MOMENT AND SHEAR CAPACITY FOR GRADE 1.4462 (2205)

D x D mm	t mm	Mass per Metre kg	Section Classification	Moment Capacity M_c kNm	Second Moment Of Area I_x, I_y cm^4	Shear Capacity P_v kN
40 x 40	2.0	2.27	Plastic	<i>1.84</i>	6.66	39.6
	3.0	3.20	Plastic	<i>2.40</i>	8.69	55.9
50 x 50	2.0	2.90	Compact	<i>2.98</i>	13.7	50.6
	3.0	4.15	Plastic	<i>4.08</i>	18.5	72.5
	4.0	5.27	Plastic	<i>4.85</i>	22.0	92.1
60 x 60	2.0	3.53	Slender	<i>3.61</i>	24.5	61.7
	3.0	5.10	Plastic	<i>6.20</i>	33.7	89.1
	4.0	6.54	Plastic	<i>7.55</i>	41.0	114
	5.0	7.84	Plastic	<i>8.56</i>	46.5	136
80 x 80	2.0	4.79	Slender	<i>5.90</i>	60.6	83.7
	3.0	6.99	Semi-compact	<i>9.81</i>	85.3	122
	4.0	9.06	Plastic	<i>14.7</i>	106	158
	5.0	11.0	Plastic	<i>17.2</i>	124	192
100 x 100	3.0	8.89	Slender	<i>14.6</i>	173	155
	4.0	11.6	Compact	<i>23.9</i>	219	202
	5.0	14.2	Plastic	<i>28.7</i>	260	247
	6.0	16.6	Plastic	<i>32.6</i>	295	290
	8.0	21.1	Plastic	<i>38.8</i>	351	368
125 x 125	3.0	11.3	Slender	<i>21.3</i>	348	196
	4.0	14.8	Slender	<i>31.0</i>	446	257
	5.0	18.1	Compact	<i>46.6</i>	535	316
	6.0	21.3	Plastic	<i>54.3</i>	616	372
	8.0	27.4	Plastic	<i>66.5</i>	752	478
150 x 150	3.0	13.6	Slender	<i>29.0</i>	613	238
	4.0	17.9	Slender	<i>42.3</i>	792	312
	5.0	22.1	Slender	<i>56.5</i>	957	385
	6.0	26.1	Compact	<i>80.6</i>	1110	455
	8.0	33.7	Plastic	<i>101</i>	1380	589
175 x 175	4.0	21.1	Slender	<i>54.9</i>	1280	368
	5.0	26.0	Slender	<i>73.5</i>	1560	454
	6.0	30.8	Slender	<i>92.9</i>	1820	538
	8.0	40.0	Plastic	<i>143</i>	2280	699
	10.0	48.7	Plastic	<i>169</i>	2680	851
200 x 200	4.0	24.2	Slender	<i>68.6</i>	1940	423
	5.0	30.0	Slender	<i>92.2</i>	2370	523
	6.0	35.6	Slender	<i>116</i>	2770	621
	8.0	46.4	Compact	<i>191</i>	3510	809
	10.0	56.6	Plastic	<i>229</i>	4160	989
250 x 250	5.0	37.9	Slender	<i>134</i>	4740	661
	6.0	45.0	Slender	<i>170</i>	5570	786
	8.0	59.0	Slender	<i>248</i>	7140	1030
	10.0	72.4	Compact	<i>373</i>	8570	1270
	12.0	85.4	Plastic	<i>434</i>	9860	1490
300 x 300	5.0	45.8	Slender	<i>173</i>	8320	799
	6.0	54.5	Slender	<i>231</i>	9820	952
	8.0	71.6	Slender	<i>338</i>	12700	1250
	10.0	88.2	Slender	<i>451</i>	15300	1540
	12.0	104	Compact	<i>644</i>	17800	1820
350 x 350	6.0	64.0	Slender	<i>299</i>	15800	1120
	8.0	84.3	Slender	<i>439</i>	20500	1470
	10.0	104	Slender	<i>588</i>	24900	1820
	12.0	123	Slender	<i>743</i>	29100	2150
	15.0	151	Plastic	<i>1080</i>	34700	2640

M_c values in *italic type* are governed by $1.2p_y Z$ and a higher value may be used in some circumstances.

For explanation of table see Section 8.6.

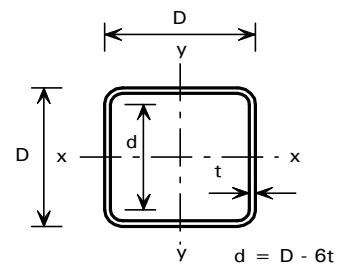
Table 78**BENDING****SQUARE HOLLOW SECTIONS
SUBJECT TO BENDING****MOMENT AND SHEAR CAPACITY FOR GRADE 1.4462 (2205)**

D x D mm	t mm	Mass per Metre kg	Section Classification	Moment Capacity M_c kNm	Second Moment Of Area I_x, I_y cm^4	Shear Capacity P_v kN
400 x 400	6.0	73.5	Slender	344	23900	1280
	8.0	96.9	Slender	549	31000	1690
	10.0	119	Slender	737	37900	2090
	12.0	142	Slender	935	44300	2480
	15.0	174	Semi-compact	1230	53300	3050

M_c values in *italic type* are governed by $1.2p_y Z$ and a higher value may be used in some circumstances.

For explanation of table see Section 8.6.

Table 79

BENDING

**CHANNELS
SUBJECT TO BENDING**

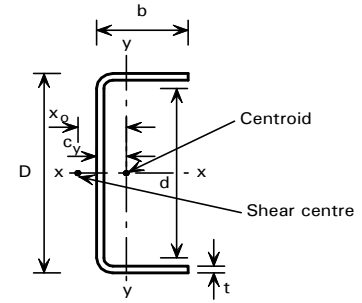

MOMENT CAPACITY AND BUCKLING RESISTANCE MOMENT FOR GRADE 1.4462 (2205)

D x b mm	t mm	Section Classification	Moment Capacity		Buckling Resistance Moment, M_b (kNm)														Shear Capacity P_v kN
			M_{cx} kNm	M_{cy} kNm	for Effective lengths, L_E (m)														
					1.0	1.5	2.0	2.5	3.0	3.5	4.0	5.0	6.0	7.0	8.0	9.0	10.0		
50 x 25	2.0	Slender	1.07	0.155	0.584	0.401	0.304	0.246	0.206	0.178	0.157	0.127	0.106	0.092	0.081	0.072	0.065	27.6	
	3.0	Semi-compact	1.70	0.414	1.05	0.769	0.602	0.495	0.420	0.364	0.322	0.262	0.221	0.191	0.168	0.150	0.136	41.4	
75 x 35	3.0	Slender	3.52	0.503	2.46	1.76	1.34	1.08	0.909	0.784	0.690	0.558	0.468	0.404	0.356	0.318	0.287	62.1	
	4.0	Slender	4.90	1.03	3.55	2.69	2.12	1.75	1.48	1.29	1.14	0.928	0.783	0.677	0.597	0.534	0.483	82.8	
	5.0	Compact	6.92	1.60	5.08	3.90	3.11	2.57	2.19	1.91	1.69	1.38	1.16	1.01	0.889	0.796	0.720	103	
100 x 50	3.0	Slender	6.03	0.699	5.22	4.08	3.12	2.46	2.03	1.72	1.50	1.19	0.990	0.849	0.744	0.663	0.598	82.8	
	4.0	Slender	8.57	1.24	7.36	5.89	4.67	3.81	3.21	2.77	2.43	1.97	1.65	1.43	1.26	1.12	1.01	110	
	5.0	Slender	11.1	2.11	9.58	7.88	6.45	5.38	4.60	4.01	3.56	2.90	2.45	2.12	1.87	1.68	1.52	138	
125 x 50	3.0	Slender	8.37	0.686	7.08	5.28	3.85	2.94	2.37	1.98	1.70	1.33	1.10	0.934	0.815	0.724	0.651	103	
	4.0	Slender	11.8	1.26	9.88	7.49	5.66	4.47	3.69	3.14	2.74	2.18	1.82	1.56	1.37	1.22	1.10	138	
	5.0	Slender	15.4	2.18	12.8	9.93	7.75	6.28	5.27	4.54	3.99	3.22	2.70	2.33	2.05	1.83	1.66	172	
	6.0	Semi-compact	18.8	3.44	15.7	12.5	10.1	8.30	7.05	6.13	5.42	4.41	3.72	3.21	2.83	2.54	2.29	207	
150 x 60	4.0	Slender	16.4	1.46	14.9	12.1	9.32	7.29	5.91	4.95	4.26	3.34	2.75	2.35	2.05	1.82	1.64	165	
	5.0	Slender	21.5	2.40	19.2	15.7	12.4	9.92	8.21	7.00	6.10	4.86	4.05	3.48	3.05	2.72	2.45	207	
	6.0	Slender	26.5	3.77	23.7	19.5	15.7	12.9	10.8	9.35	8.22	6.63	5.56	4.80	4.22	3.77	3.41	248	
	8.0	Semi-compact	34.9	6.51	31.4	26.9	22.7	19.3	16.7	14.7	13.1	10.7	9.07	7.87	6.96	6.24	5.65	331	
175 x 60	5.0	Slender	26.9	2.43	23.9	19.0	14.5	11.4	9.27	7.80	6.74	5.32	4.40	3.76	3.29	2.92	2.63	241	
	6.0	Slender	33.2	3.84	29.3	23.5	18.3	14.7	12.2	10.4	9.05	7.23	6.03	5.18	4.55	4.05	3.66	289	
	8.0	Semi-compact	43.8	6.67	38.8	32.3	26.4	22.0	18.7	16.3	14.4	11.7	9.85	8.53	7.52	6.73	6.09	386	
	10.0	Plastic	61.0	9.66	55.4	45.9	37.8	31.7	27.2	23.8	21.1	17.2	14.6	12.6	11.2	10.0	9.06	483	
200 x 75	5.0	Slender	35.3	2.85	33.9	29.5	24.3	19.5	15.9	13.2	11.3	8.70	7.09	6.00	5.20	4.60	4.13	276	
	6.0	Slender	43.9	4.28	41.8	36.4	30.1	24.5	20.2	17.1	14.8	11.6	9.59	8.18	7.14	6.35	5.71	331	
	8.0	Slender	61.2	8.76	57.8	50.5	42.6	35.7	30.3	26.2	23.0	18.6	15.6	13.4	11.8	10.5	9.53	441	
	10.0	Semi-compact	75.0	12.9	70.9	62.9	54.7	47.3	41.2	36.3	32.3	26.5	22.5	19.5	17.3	15.5	14.0	552	
225 x 75	6.0	Slender	52.3	4.30	49.6	42.7	34.8	27.8	22.6	18.9	16.2	12.6	10.3	8.75	7.61	6.74	6.06	372	
	8.0	Slender	72.8	8.90	68.4	58.9	48.8	40.1	33.5	28.7	25.0	20.0	16.7	14.3	12.5	11.2	10.1	496	
	10.0	Semi-compact	89.3	13.1	83.9	73.4	62.6	53.1	45.5	39.7	35.2	28.6	24.1	20.9	18.4	16.5	14.9	621	
	12.0	Plastic	121	18.3	116	100	85.0	72.0	62.0	54.2	48.2	39.4	33.3	28.9	25.5	22.8	20.7	745	
250 x 100	6.0	Slender	67.0	5.49	67.0	62.8	56.7	49.5	42.2	35.9	30.8	23.5	18.9	15.8	13.6	11.9	10.6	414	
	8.0	Slender	94.7	10.1	94.7	87.8	79.0	69.3	59.9	51.8	45.3	35.8	29.5	25.1	21.9	19.4	17.5	552	
	10.0	Slender	122	17.4	122	113	102	90.5	79.4	69.9	62.0	50.2	42.1	36.3	31.9	28.5	25.7	690	
	12.0	Semi-compact	150	27.6	149	137	125	112	100	89.5	80.4	66.4	56.4	49.0	43.4	38.9	35.2	828	
300 x 100	8.0	Slender	123	10.2	123	113	101	87.1	73.6	62.4	53.6	41.4	33.6	28.3	24.4	21.5	19.3	662	
	10.0	Slender	160	17.8	159	146	130	112	96.6	83.2	72.6	57.5	47.6	40.6	35.4	31.5	28.3	828	
	12.0	Semi-compact	196	28.3	194	177	158	139	121	106	93.8	75.8	63.5	54.7	48.1	43.0	38.8	993	
	15.0	Compact	275	41.2	275	254	224	196	171	150	134	109	92.9	80.5	71.0	63.6	57.6	1240	
350 x 125	8.0	Slender	167	12.1	167	164	152	139	124	109	95.1	73.2	58.4	48.3	41.1	35.8	31.7	772	
	10.0	Slender	218	19.9	218	212	197	179	160	141	124	98.1	79.9	67.3	58.1	51.1	45.7	966	
	12.0	Slender	270	31.1	270	261	242	221	198	176	156	125	104	89.1	77.7	69.0	62.0	1160	
	15.0	Semi-compact	345	54.8	345	332	309	283	257	232	209	172	146	126	111	99.8	90.3	1450	
400 x 150	8.0	Slender	215	14.8	215	215	208	196	182	167	150	119	95.6	78.4	65.9	56.6	49.6	883	
	10.0	Slender	282	22.8	282	282	270	254	236	215	194	156	126	105	90.3	78.6	69.6	1100	
	12.0	Slender	351	34.2	351	351	334	314	291	266	240	196	161	136	118	104	93.0	1320	
	15.0	Slender	455	59.4	455	454	430	404	375	344	314	261	220	190	166	148	133	1660	

Section classification applies to bending about both the x-x and y-y axis.

Moment capacity values in *italic type* are governed by $1.2p_y Z$ and a higher value may be used in some circumstances.

M_b is obtained using an equivalent slenderness $= uv\lambda(\beta_w^{0.5})$.

In certain cases, M_b may be greater than M_{cx} , which implies that lateral torsional buckling is not critical.

For explanation of table see Section 8.6.

Table 80

BENDING

**DOUBLE CHANNELS BACK TO BACK
SUBJECT TO BENDING**

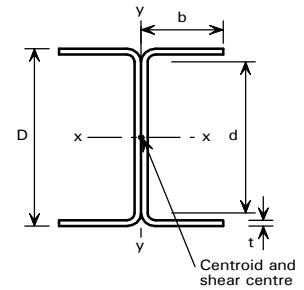

MOMENT CAPACITY AND BUCKLING RESISTANCE MOMENT FOR GRADE 1.4462 (2205)

D x 2b mm	t mm	Section Classification	Moment Capacity		Buckling Resistance Moment, M_b (kNm)														Shear Capacity P_v kN
			M_{cx} kNm	M_{cy} kNm	for Effective lengths, L_E (m)														
					1.0	1.5	2.0	2.5	3.0	3.5	4.0	5.0	6.0	7.0	8.0	9.0	10.0		
50 x 50	2.0	Slender	2.10	0.574	1.30	0.937	0.729	0.599	0.510	0.445	0.395	0.324	0.275	0.239	0.212	0.191	0.173	55.2	
	3.0	Slender	3.31	1.12	2.25	1.75	1.43	1.21	1.05	0.925	0.829	0.689	0.590	0.516	0.459	0.414	0.377	82.8	
75 x 70	3.0	Slender	6.90	1.76	5.23	3.92	3.08	2.53	2.16	1.88	1.67	1.37	1.16	1.01	0.899	0.808	0.735	124	
	4.0	Slender	9.53	2.83	7.40	5.81	4.76	4.03	3.49	3.09	2.77	2.30	1.97	1.73	1.54	1.39	1.27	165	
	5.0	Semi-compact	11.5	3.84	9.42	7.75	6.56	5.68	5.01	4.48	4.05	3.41	2.94	2.59	2.32	2.10	1.92	207	
100 x 100	3.0	Slender	11.9	2.94	11.2	8.98	7.20	5.88	4.92	4.21	3.68	2.95	2.47	2.13	1.87	1.68	1.52	165	
	4.0	Slender	16.8	4.59	15.6	12.7	10.4	8.74	7.50	6.56	5.84	4.79	4.08	3.56	3.16	2.84	2.59	220	
	5.0	Slender	21.7	6.60	20.2	16.7	14.0	12.1	10.5	9.36	8.43	7.04	6.06	5.32	4.75	4.30	3.92	276	
125 x 100	3.0	Slender	16.5	2.93	14.8	11.5	8.84	6.97	5.68	4.76	4.10	3.20	2.64	2.25	1.97	1.75	1.58	207	
	4.0	Slender	23.2	4.58	20.6	16.0	12.6	10.2	8.51	7.29	6.39	5.14	4.31	3.73	3.29	2.95	2.67	276	
	5.0	Slender	30.0	6.60	26.4	20.9	16.8	13.9	11.9	10.3	9.17	7.51	6.38	5.56	4.93	4.44	4.04	345	
	6.0	Slender	36.6	8.97	32.3	26.0	21.4	18.1	15.7	13.8	12.4	10.3	8.81	7.72	6.87	6.20	5.65	414	
150 x 120	4.0	Slender	32.4	5.94	31.3	25.5	20.5	16.7	13.8	11.7	10.1	7.95	6.56	5.61	4.90	4.36	3.94	331	
	5.0	Slender	42.1	8.45	40.3	32.9	26.8	22.1	18.6	16.0	14.1	11.3	9.51	8.22	7.25	6.50	5.89	414	
	6.0	Slender	51.9	11.4	49.3	40.6	33.5	28.1	24.1	21.0	18.7	15.3	13.0	11.3	10.0	9.03	8.21	496	
	8.0	Semi-compact	69.8	18.1	66.5	55.9	47.6	41.3	36.3	32.5	29.3	24.6	21.3	18.7	16.7	15.2	13.9	662	
175 x 120	5.0	Slender	52.9	8.44	49.5	39.6	31.4	25.3	21.0	17.8	15.5	12.3	10.2	8.74	7.67	6.84	6.19	483	
	6.0	Slender	65.1	11.4	60.4	48.5	39.0	32.0	27.0	23.2	20.4	16.5	13.9	12.0	10.6	9.50	8.61	579	
	8.0	Semi-compact	87.7	18.1	81.3	66.6	55.3	46.9	40.6	35.8	32.0	26.5	22.7	19.9	17.7	16.0	14.5	772	
	10.0	Compact	121	27.6	115	95.0	79.7	68.4	59.9	53.2	48.0	40.1	34.5	30.4	27.1	24.5	22.4	966	
200 x 150	5.0	Slender	69.7	11.6	69.7	61.4	51.5	43.0	36.0	30.6	26.4	20.6	16.8	14.2	12.3	10.9	9.80	552	
	6.0	Slender	86.3	15.4	86.3	75.4	63.4	53.2	45.1	38.7	33.8	26.9	22.3	19.1	16.7	14.9	13.5	662	
	8.0	Slender	119	24.8	119	103	88.2	75.4	65.3	57.3	51.0	41.8	35.5	30.9	27.4	24.7	22.5	883	
	10.0	Semi-compact	149	35.3	149	130	113	99.0	87.5	78.2	70.7	59.3	51.2	45.1	40.3	36.5	33.4	1100	
225 x 150	6.0	Slender	102	15.4	102	87.8	72.8	60.3	50.4	42.8	37.0	29.0	23.8	20.3	17.7	15.7	14.1	745	
	8.0	Slender	142	24.8	142	120	100	84.9	72.4	62.9	55.4	44.8	37.7	32.7	28.8	25.9	23.5	993	
	10.0	Semi-compact	178	35.4	178	151	129	111	96.8	85.6	76.7	63.6	54.4	47.6	42.4	38.3	34.9	1240	
	12.0	Compact	242	51.7	247	208	176	152	133	118	106	89.4	76.9	67.6	60.4	54.6	49.9	1490	
250 x 200	6.0	Slender	132	23.5	132	132	118	104	91.8	80.5	70.7	55.8	45.4	38.1	32.8	28.8	25.6	828	
	8.0	Slender	185	36.6	185	185	164	145	128	113	100	81.5	68.0	58.4	51.1	45.5	41.1	1100	
	10.0	Slender	240	52.8	240	237	211	187	167	149	134	111	94.9	82.7	73.4	66.0	60.1	1380	
	12.0	Slender	293	71.7	293	288	258	231	208	188	171	144	125	110	99.2	89.9	82.3	1660	
300 x 200	8.0	Slender	243	36.6	243	237	208	181	156	136	119	94.2	77.2	65.2	56.5	49.9	44.7	1320	
	10.0	Slender	314	52.8	314	303	266	232	203	178	157	127	106	91.7	80.5	71.9	65.0	1660	
	12.0	Slender	383	71.9	383	368	324	285	251	223	200	165	140	122	108	97.7	88.9	1990	
	15.0	Semi-compact	459	95.2	459	444	396	355	319	289	264	224	195	173	155	141	129	2480	
350 x 250	8.0	Slender	330	50.5	330	330	320	289	260	232	207	166	136	114	97.6	85.1	75.4	1550	
	10.0	Slender	429	71.5	429	429	411	371	334	299	268	218	181	154	133	118	106	1930	
	12.0	Slender	529	96.3	529	529	503	454	409	369	333	274	231	200	175	156	141	2320	
	15.0	Slender	676	140	676	676	639	580	526	478	436	368	317	278	248	224	204	2900	
400 x 300	8.0	Slender	426	66.7	426	426	426	413	381	349	320	266	221	186	158	137	121	1770	
	10.0	Slender	557	92.8	557	557	557	533	491	450	412	343	288	245	211	185	164	2210	
	12.0	Slender	690	123	690	690	690	655	603	553	507	425	360	309	270	239	214	2650	
	15.0	Slender	890	178	890	890	890	838	772	711	654	557	479	419	371	333	302	3310	

Section classification applies to bending about both the x-x and y-y axis.

Moment capacity values in *italic type* are governed by $1.2p_y Z$ and a higher value may be used in some circumstances.

M_b is obtained using an equivalent slenderness $= \nu \lambda (\beta_w)^{0.5}$.

In certain cases, M_b may be greater than M_{cx} , which implies that lateral torsional buckling is not critical.

For explanation of table see Section 8.6.

[Blank Page]

اگر تمایل دارید هر روز
محتوای جذاب متنی، ویدئویی و اینفوگرافیک
از موضوعات متنوع مواد مهندسی و فرایندهای ساخت و تولید
را مشاهده و دانلود کنید
و از اخبار، رویدادها و تحلیل های صنعتی مطلع باشید،
بازدید از عصر مواد و شبکه های اجتماعی آن را
در برنامه وب گردی های روزانه خود قرار دهید.



www.asremavad.com